

\$2.25

# **basic electronics**

**by VAN VALKENBURGH,  
NOOGER & NEVILLE, INC.**

**VOL. 1**



**JOHN F. RIDER PUBLISHER, INC.**  
116 West 14th Street • New York 11, N. Y.

First Edition

*Copyright 1955 by*

VAN VALKENBURGH, NOOGER AND NEVILLE, INC.

All Rights Reserved under International and Pan American Conventions. This book or parts thereof may not be reproduced in any form or in any language without permission of the copyright owner.

*Library of Congress Catalog Card No. 55-6984*

Printed in the United States of America

## PREFACE

The texts of the entire Basic Electricity and Basic Electronics courses, as currently taught at Navy specialty schools, have now been released by the Navy for civilian use. This educational program has been an unqualified success. Since April, 1953, when it was first installed, over 25,000 Navy trainees have benefited by this instruction and the results have been outstanding.

The unique simplification of an ordinarily complex subject, the exceptional clarity of illustrations and text, and the plan of presenting one basic concept at a time, without involving complicated mathematics, all combine in making this course a better and quicker way to teach and learn basic electricity and electronics.

In releasing this material to the general public, the Navy hopes to provide the means for creating a nation-wide pool of pre-trained technicians, upon whom the Armed Forces could call in time of national emergency, without the need for precious weeks and months of schooling.

Perhaps of greater importance is the Navy's hope that through the release of this course, a direct contribution will be made toward increasing the technical knowledge of men and women throughout the country, as a step in making and keeping America strong.

*Van Valkenburgh, Nooger and Neville, Inc.*

*New York, N. Y.*

*February, 1955*





## TABLE OF CONTENTS

### VOL. 1 — BASIC ELECTRONICS

Introduction to Electronics . . . . .	1-1
What a Power Supply Is . . . . .	1-7
Half-Wave Rectifiers — Dry Metal Type . . . . .	1-17
Half-Wave Rectifiers — Vacuum Tube Type . . . . .	1-23
Half-Wave Rectifiers — Transformer Type . . . . .	1-39
The Full-Wave Rectifier Circuit . . . . .	1-45
Filter Circuits . . . . .	1-52
Voltage Regulator Circuits . . . . .	1-81
Other Types of Power Supply Circuits . . . . .	1-92
Characteristics of Diode Vacuum Tubes . . . . .	1-109



*introduction to*

# ELECTRONICS

## What You Are Going To Do Now

You now have a good solid foundation in the field of electricity. You know how electricity is generated, how electron current flows through a circuit, the nature and uses of magnetism, the proper use and care of meters, the characteristics of DC and AC and how various types of electrical motors and other electrical devices operate.

Now you have all the fundamental knowledge that you need to begin your study of a new and fascinating subject—electronics.

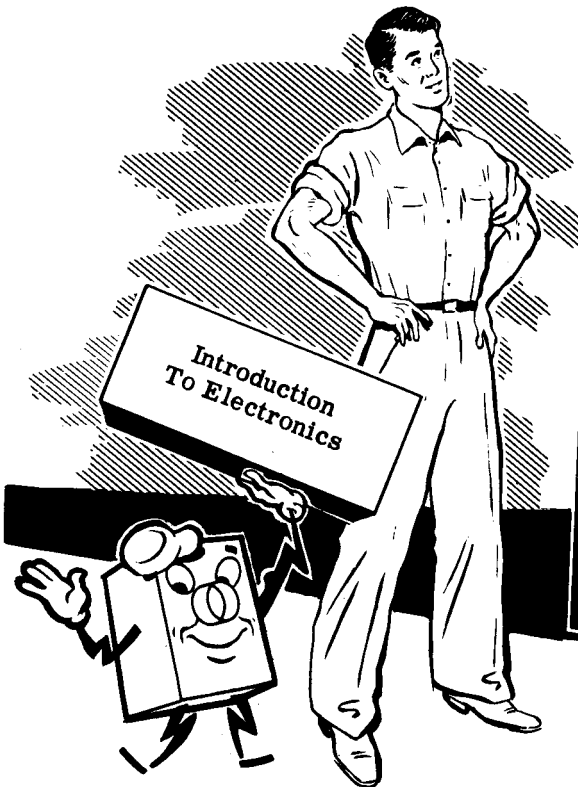

## BASIC ELECTRICITY

Vol. 5  
DC & AC  
Machinery

Vol. 4  
AC Circuits

Vol. 3  
Alternating  
Current

Vol. 2  
DC Circuits

Vol. 1  
Introduction to  
Electricity



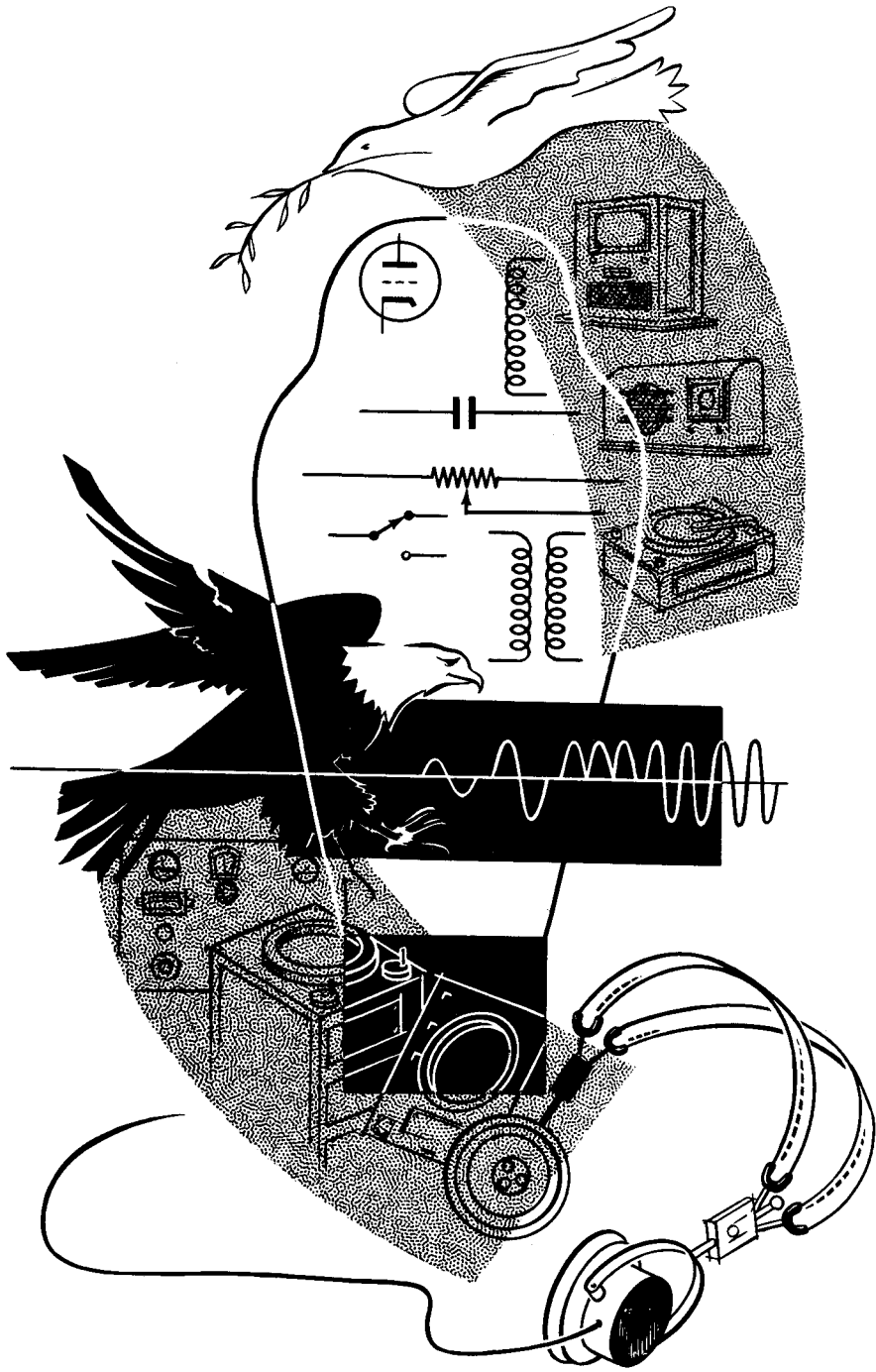

*Introduction to electronics*



# INTRODUCTION TO ELECTRONICS

## The Meaning of "Electronics"

You have heard the word "electronics" many times in the past. Electronics means the science of the electron. Since the study of electricity and electronics both involve the use of the concept of electron flow, you may wonder where electricity ends and electronics begins. For your purposes it is easy enough to make the distinction that electronics is the science which is concerned with the flow of electrons through vacuum or gas-filled tubes sometimes called "electron tubes." Thus, electronics includes the study of any equipment that contains "tubes."

You are already acquainted with quite a few types of electronic equipment. Radio—"talkie" motion pictures—record players—public address systems—television—"electric eye" door openers—all of these make use of "tubes" and are correctly termed electronic equipment. Of course they also make use of various types of DC and AC circuits, of meters, transformers, capacitors, and all the other components which you have learned about in Basic Electricity. That is why you needed a course in fundamentals before going on with the electronics phase of your study.

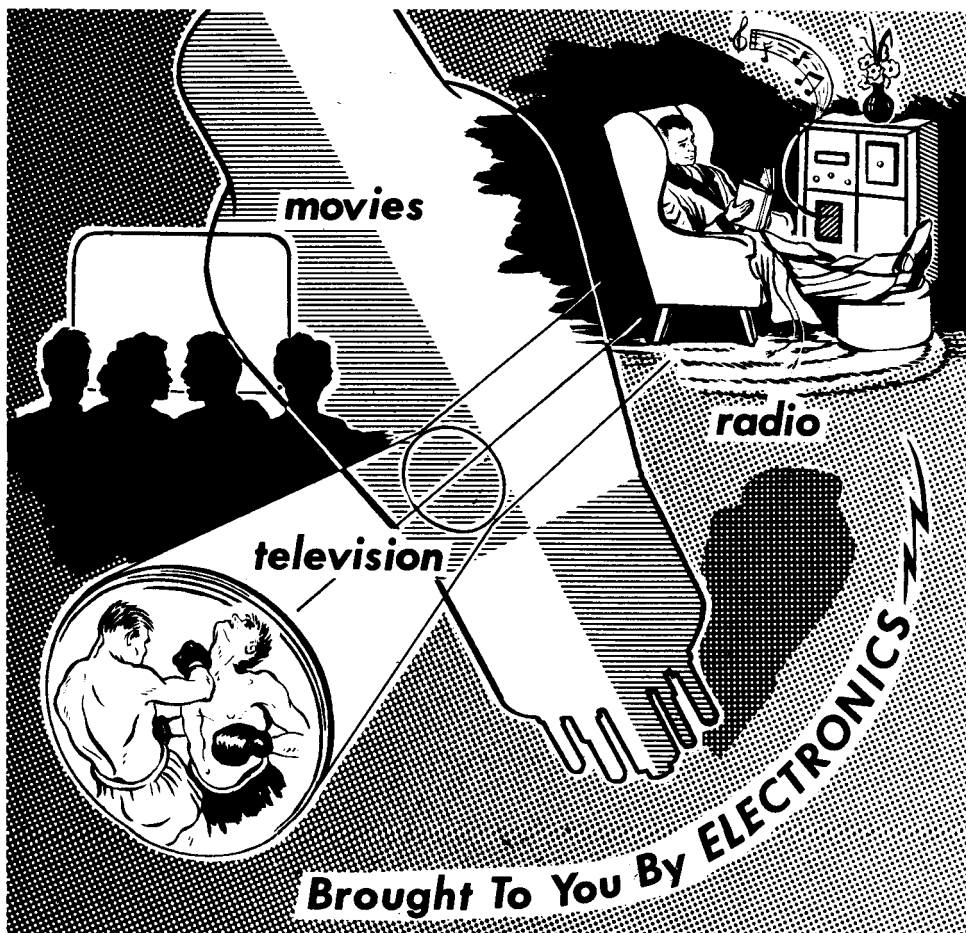

# INTRODUCTION TO ELECTRONICS

## Electronic Equipment

All electronic equipment is made up of only a few basic circuits. Just how many basic types of circuit are there? Three! Are there any other types you will ever have to know? There are additional types of special circuits you will have to learn when you begin to study equipment, but these special circuits are nothing but variations of the three basic electronic circuits.

The three basic electronic circuits are rectifier circuits, amplifier circuits and oscillator circuits.

Rectifier circuits change AC to DC. Their most common use is in electronic equipment power supplies which take AC from the power line and transform it to DC which is required to operate electron tubes.

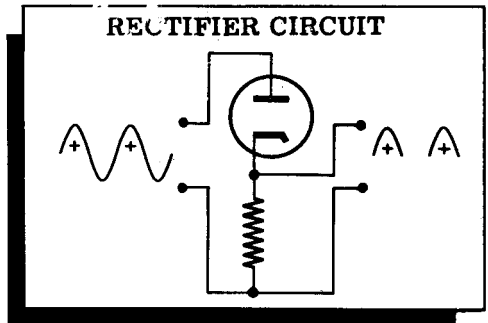

Amplifier circuits take small voltage changes and enlarge or amplify them into large voltage changes. Amplifier circuits are by far the most commonly used circuits in electronic equipment. They take very weak signals that are barely detectable and amplify them into strong signals that can drive a pair of earphones, a loudspeaker or an oscilloscope.

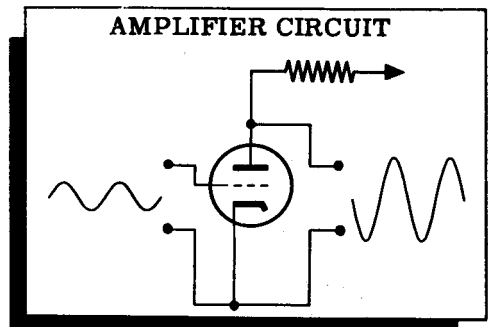

Oscillator circuits generate AC voltages at any particular desired frequency. Oscillator circuits are used to generate the AC voltages that carry a radio signal from one place to another. They are also used very extensively for testing other electronic circuits.

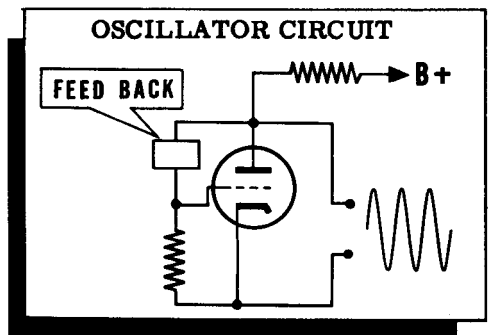



# INTRODUCTION TO ELECTRONICS

## Parts Used in Electronic Equipment

Now that you have found out that there are only three basic types of electronic circuits (rectifiers, amplifiers and oscillators) that you have to be concerned with, you probably would like to know about the parts used in those circuits. Actually there are only six commonly used types of parts in electronic circuits. Five of these parts you already know—resistors, capacitors, coils, transformers and switches. There is one additional type of part that you will learn about very soon—"vacuum tubes."

You see that by understanding three basic types of electronic circuits and the use of six types of parts in those circuits, you will understand all you need to know about electronics for the present.

*From such as these  
are circuits made . . . .*

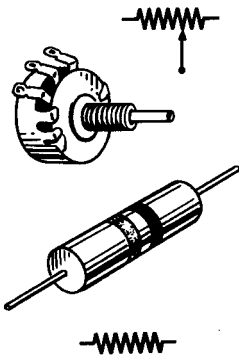

RESISTOR

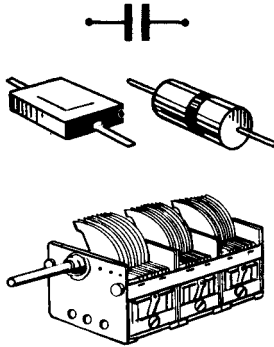

CAPACITOR

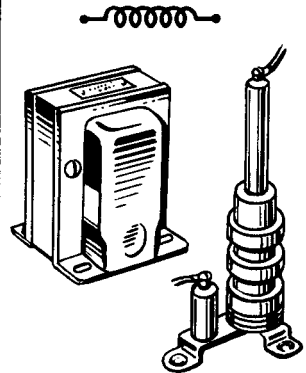

COIL OR  
INDUCTANCE

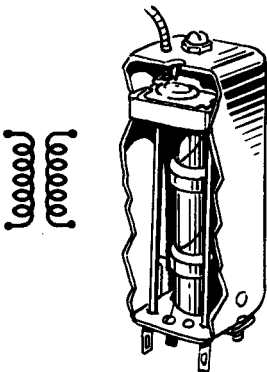

TRANSFORMER

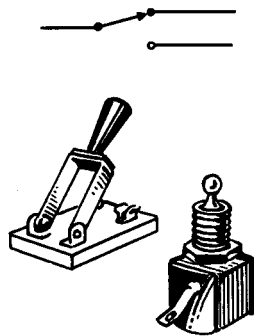

SWITCH

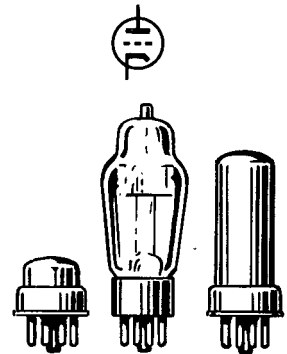

VACUUM TUBE



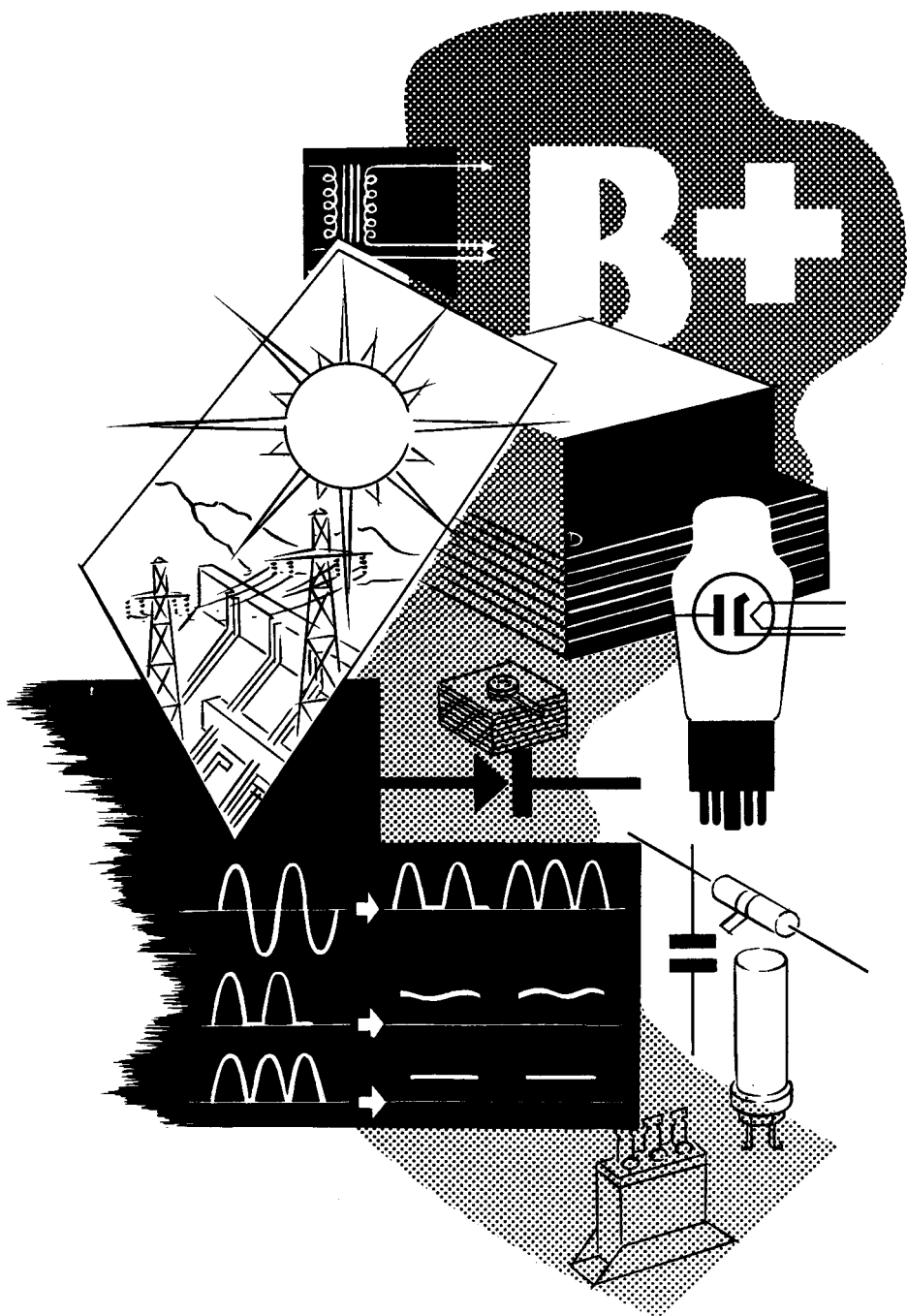

*Power Supplies*



# WHAT A POWER SUPPLY IS

## Importance of Power Supplies

Everything that lives or does work must have a source of power or a "power supply." The sun supplies power that enables plants to manufacture food, and food in turn supplies the power that makes you live and move, - speak, run, and think. In the realm of non-living mechanisms, the motor in the old Model "T" supplied power to move the car as surely as the huge turbines at Boulder Dam supply power today to drive electric generators.

It is obvious that the same kind of power is not used in the same way in these different cases. Each thing—large or small, living or non-living—must take its power from a primary source such as the sun, falling water, or an electric light socket and change it into the specific kind of power needed. In electronics, then, a "power supply" is a circuit or device that changes the primary electric power into the kind and amount of AC or DC needed by different types of electronic circuits.

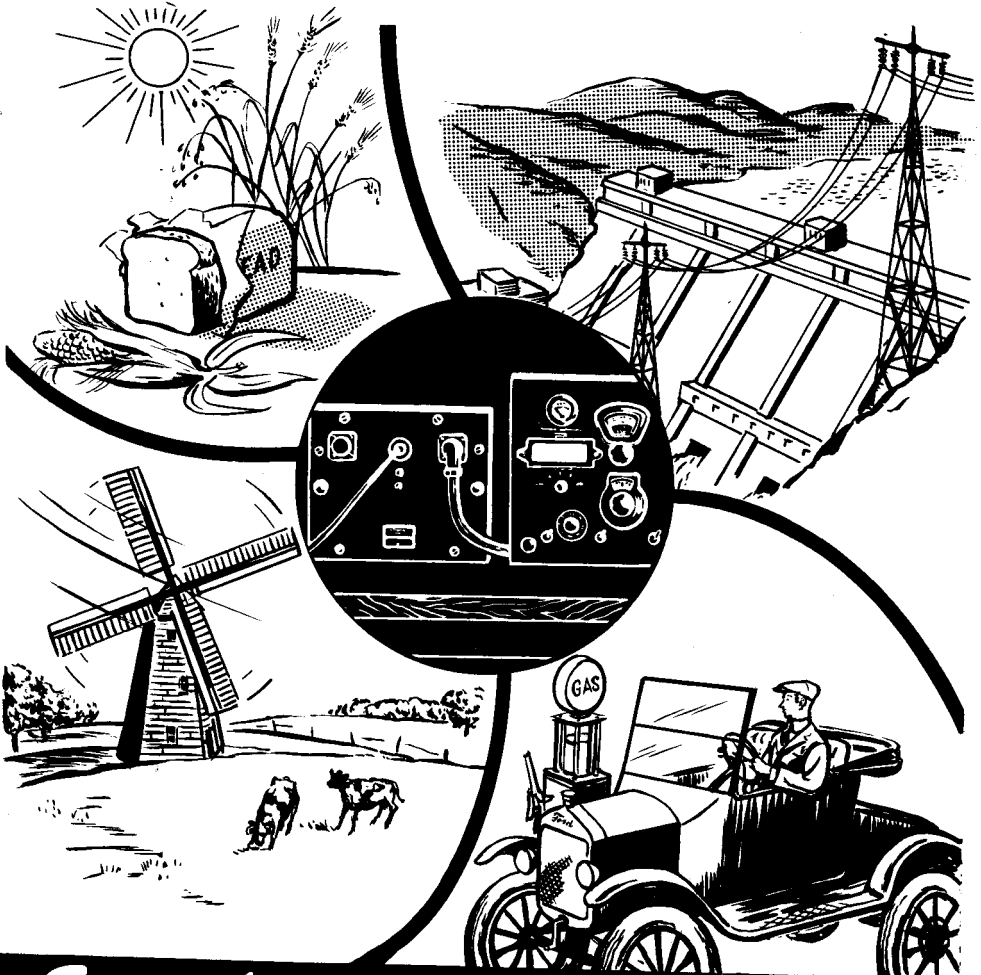

*Everything needs its* **POWER SUPPLY**

# WHAT A POWER SUPPLY IS

## What Power Supplies Do

Let's get down to cases and find out just what a power supply is supposed to do. Different types of electronic equipment—amplifiers, oscillators, transmitters and receivers—contain different types of vacuum tube circuits which must have certain AC and DC voltages supplied to them before they can operate. While there are exceptions, in general these various vacuum tube circuits require approximately 350 volts DC and 6.3 volts AC. Just why these two voltages are required is something you will learn when you come to study these circuits. For the present it is enough for you to know that the usual power supply must put out these voltages.

When you plug any piece of electronic equipment into an electric outlet, that outlet puts out 117 volts AC. That is not what you want—the vacuum tube circuits usually must have 350 volts DC and 6.3 volts AC. How a power supply changes the available line voltage into the high DC voltage (called "B+" voltage in all electronics work) and low AC voltage is the major subject of this section.

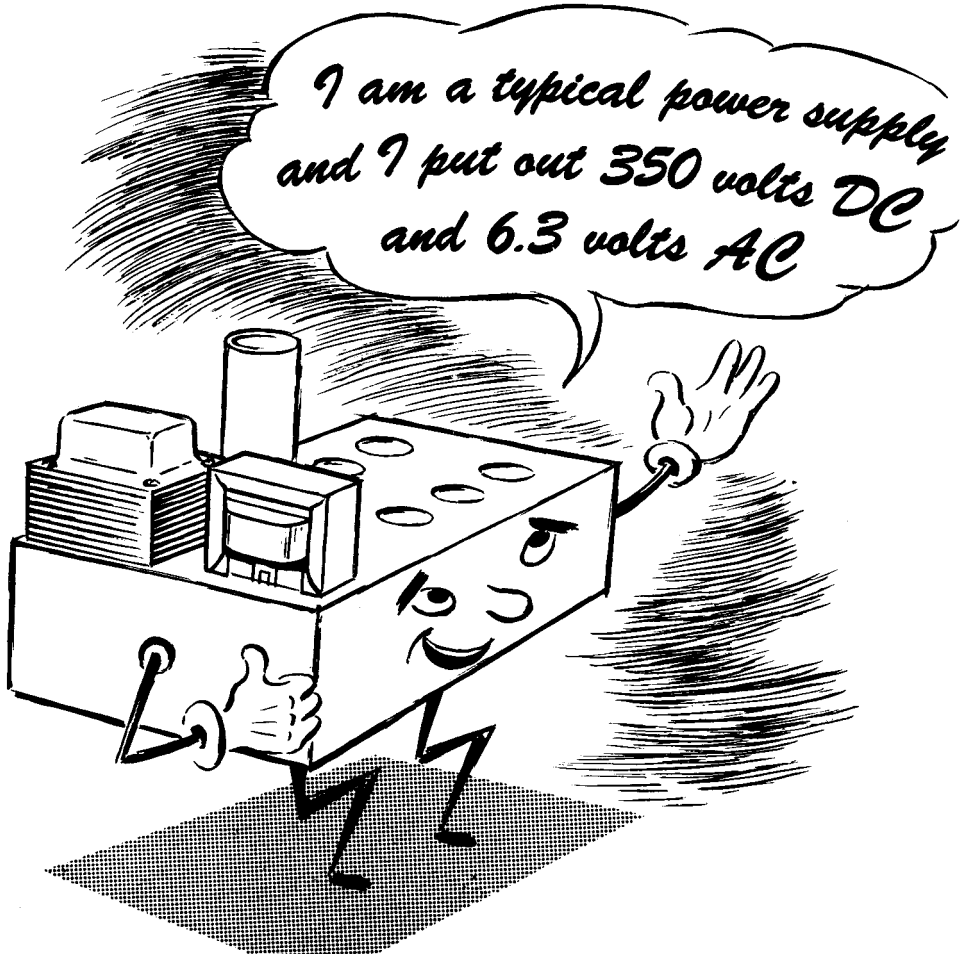

# WHAT A POWER SUPPLY IS

## How a Power Supply Works—The Transformer

A typical power supply consists of three major components—a transformer, a rectifier and a filter.

You already know about transformers from your work in basic electricity. A transformer is a device made up of two or more coils of wire wound on an iron core. Transformers can take an AC voltage and increase it or decrease it depending upon the number of turns of wire in the various windings. Here are a few examples of transformers that you will find in electronic equipment power supplies.

### TYPICAL POWER TRANSFORMERS

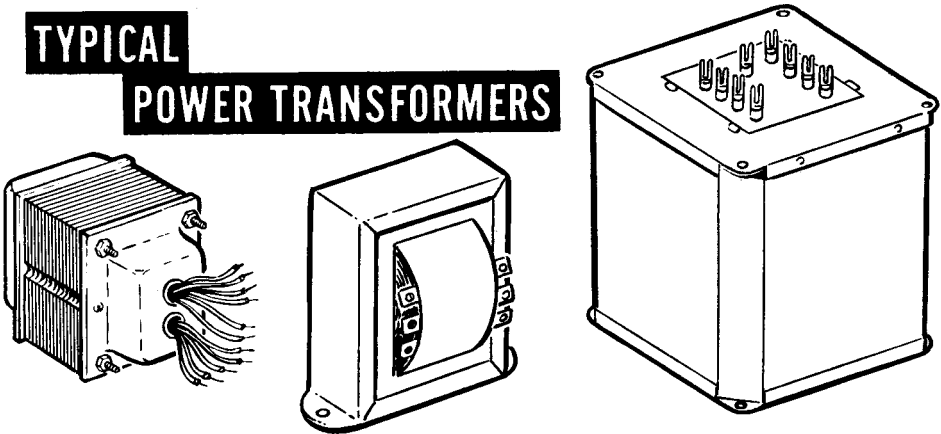

In a typical power supply the transformer is connected to the 117-volt AC power line through a suitable fuse and switch. The transformer puts out three AC voltages—a voltage somewhat higher than 350 volts AC, 5 volts AC and 6.3 volts AC. The 6.3 volt AC output is connected directly to the vacuum tube circuits. The other two voltages are connected to the rectifier circuit where the high voltage AC is changed to approximately 350 volts DC. More than 350 volts AC are required to get 350 volts DC because of losses that occur in the process of changing AC to DC, so you must begin with a higher voltage than you want to take out.

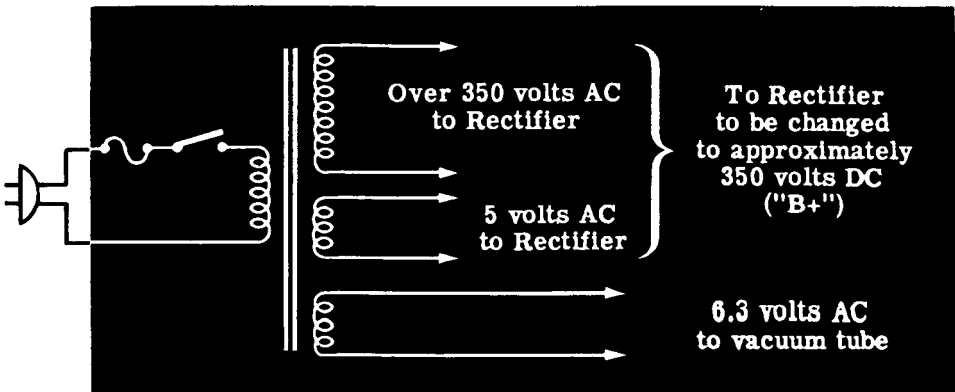

## WHAT A POWER SUPPLY IS

### How a Power Supply Works—The Rectifier

Up to now you have learned that the job of a typical power supply is to take 117 volts AC from the power line and to put out approximately 350 volts DC and 6.3 volts AC. You have learned that the major components of a power supply are a transformer, a rectifier and a filter circuit; and you have found out about the job of the transformer.

The job of the rectifier is to change the high voltage AC coming out of the transformer into high voltage DC. The 5-volt AC voltage coming out of the transformer is used to heat the rectifier tube, when such a type of rectifier is used. The 5-volt AC winding is eliminated from the transformer when it is not required for the operation of the rectifier.

The job of changing high voltage AC into high voltage DC is a difficult one. All the rectifier can do is to change the AC into pulsating DC like this:

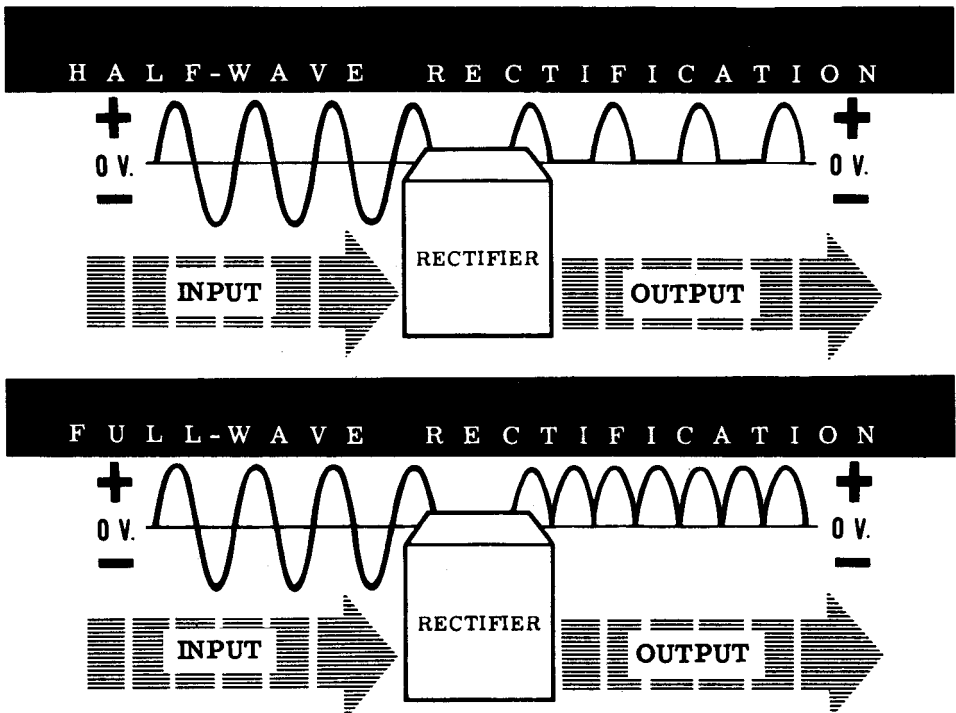

Notice that the DC output is not a constant voltage but rises and falls in time with the AC voltage input. When only the positive half cycles of the input voltage are allowed to pass through the rectifier and the negative half cycles cannot pass through at all, the process is called "half-wave rectification."

When the positive half cycle of the input voltage is allowed to pass through the rectifier and the negative half cycles are changed to positive half cycles, the process is called "full-wave rectification."



# WHAT A POWER SUPPLY IS

## How a Power Supply Works—The Rectifier (continued)

The rectifiers you will work with in this section will be dry metal or vacuum tube rectifiers. Either of these rectifiers come in half-wave or full-wave types. Vacuum tube rectifiers require that the transformer have a low voltage AC winding which supplies the rectifier tube with heater voltage. Dry metal rectifiers do not require this winding.

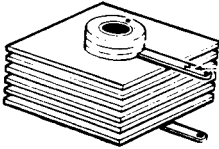

# RECTIFIERS

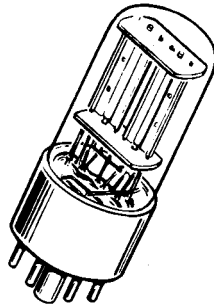
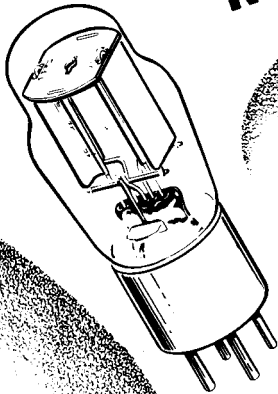

### HALF-WAVE RECTIFICATION

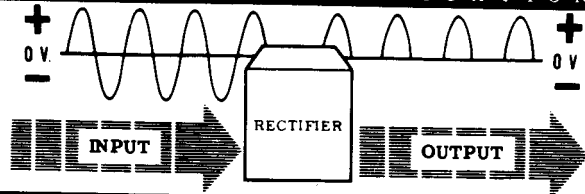

### FULL-WAVE RECTIFICATION

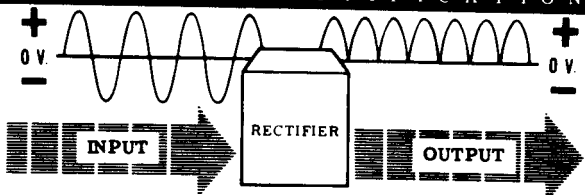

# WHAT A POWER SUPPLY IS

## How a Power Supply Works—The Filter

So far you have learned that the job of a typical power supply is to take 117 volts AC from the power line and to deliver approximately 350 volts DC and 6.3 volts AC. You have learned that the major components of a power supply are a transformer, a rectifier and a filter circuit. You have learned the purpose of the transformer and the rectifier, and now you are ready to learn about the filter.

You know that the output of the rectifier is a pulsating DC voltage. What you want is a steady DC voltage of +350 volts with as little pulsation as possible.

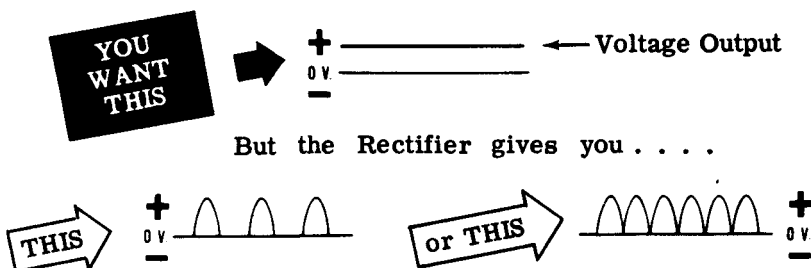

The job of the filter circuit is to smooth out the pulsations in the rectifier output and give you a steady voltage with little or no ripple. Filter circuits come in various forms, but all filter circuits are made up of various combinations of inductances and capacitors or resistances and capacitors. You will learn how these filter circuits work to smooth out the pulsations in the rectifier output as soon as you have done some work with various rectifier circuits.

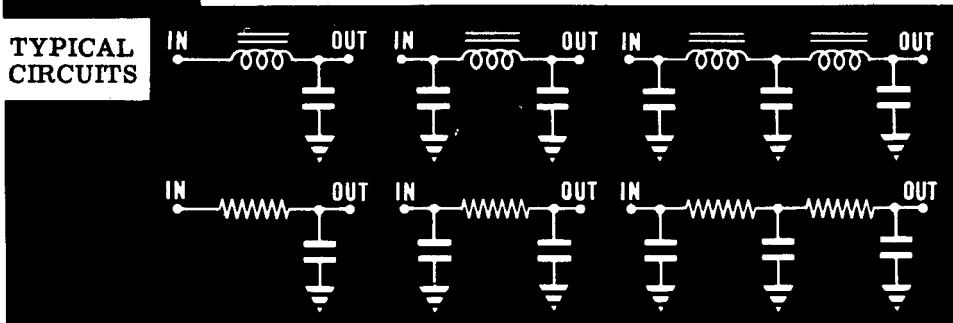
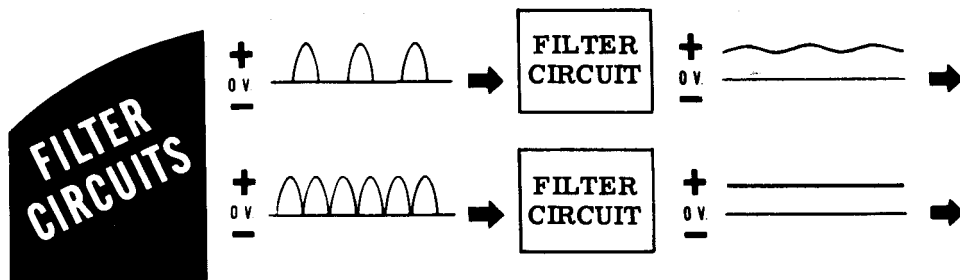

## WHAT A POWER SUPPLY IS

### Voltage Regulators

A typical power supply is made up of a transformer, a rectifier and a filter circuit. This is all that is required to give you the high voltage DC and the low voltage AC required to operate various types of electronic circuits. However, when current is drawn out of the high voltage DC terminal of a power supply, the voltage drops. This is due to the internal resistance of the power supply. It is not unusual for the 350-volt DC output to drop to 300 volts when the current drawn out increases from 0.05 amp to 0.100 amp.

This voltage drop is not serious for many types of electronic circuits, and they will go right on working in the proper manner. However, there are some types of electronic circuits that cannot operate properly if the voltage varies more than two or three volts. These types of circuits require that the power supply have a voltage regulator circuit added to it. When a power supply has a voltage regulator circuit, only those circuits that require a constant voltage are connected to the voltage regulator—other circuits are usually connected directly to the unregulated high voltage DC terminal.

The basic part of all voltage regulator circuits is the voltage regulator tube, commonly known as the "VR" tube. These tubes are made so that they will hold the DC voltage at a particular point in spite of current variations. VR tubes are made so that they will hold the voltage at 59, 75, 90, 108, and 153 volts DC. By using various combinations of these tubes, you can get a constant voltage of almost any value that is required.

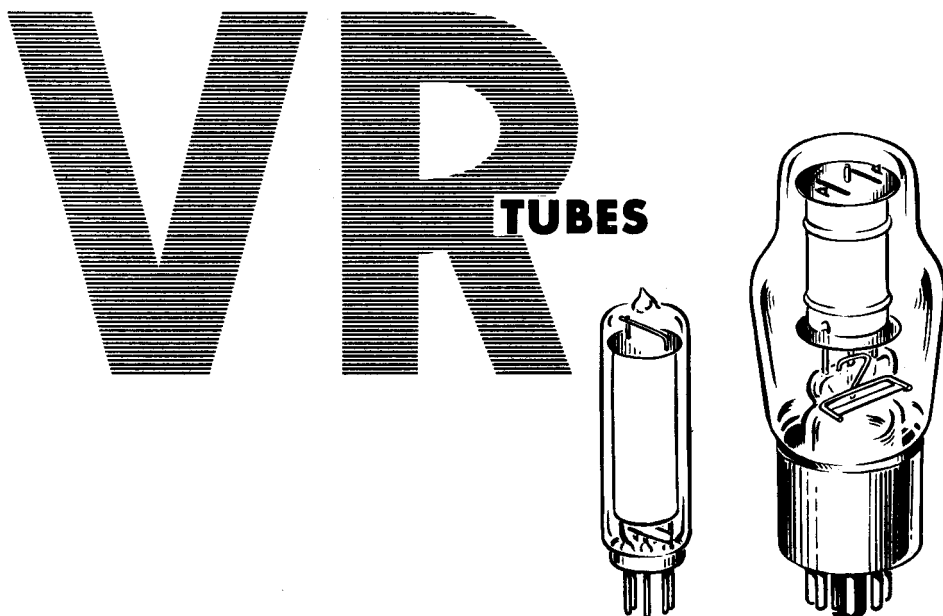

# WHAT A POWER SUPPLY IS

## Why There are Different Types of Power Supplies

You know that most power supplies are made up of transformers, rectifiers, filter circuits and sometimes voltage regulators. You can get almost any kind of power supply by putting these components together in various ways. Of course, sometimes you will have to use large rectifier tubes and large transformers; sometimes you will have to use sub-miniature parts; but, large or small, all the circuits will contain the same components.



# WHAT A POWER SUPPLY IS

## Why There are Different Types of Power Supplies (continued)

Now you will want to know why there are different types of power supplies used in various types of equipment. After all, the major job they do is nothing more than changing AC into DC.

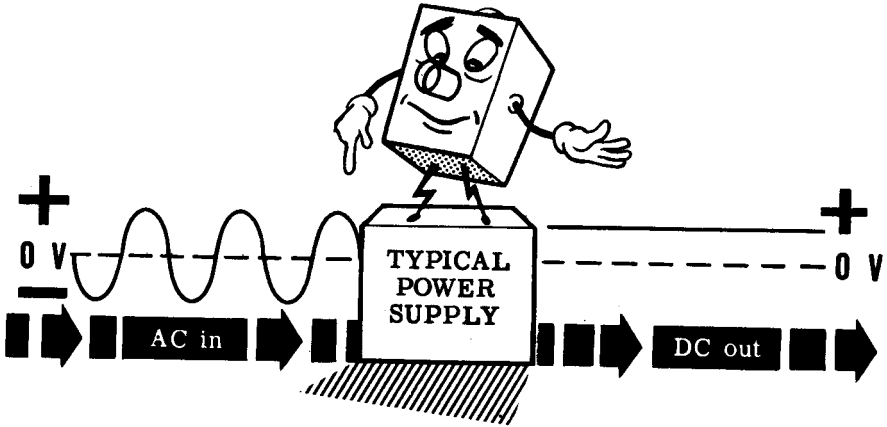

The reason why different types of power supplies are required is simple. One power supply you may build would go up in smoke if you drew much more than 150 ma. of current from the high DC voltage supply. Certain types of transmitters require as much as 5,000 or 10,000 ma. from their power supplies. Certain special oscilloscope circuits may require a DC output of 10,000 volts or more.

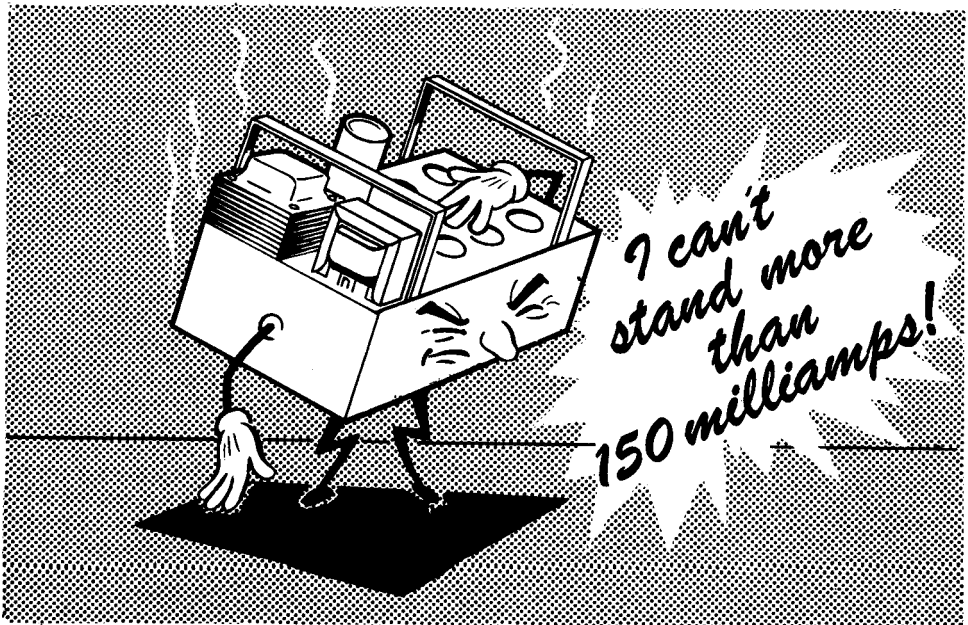

## WHAT A POWER SUPPLY IS

### Why There are Different Types of Power Supplies (continued)

Some special radar circuits require power supplies with especially good voltage regulation. This means that the DC voltage put out by the power supply must not change more than one or two volts when the current is varying.

Sometimes power supplies are needed that will put out negative DC voltages rather than positive DC voltages. Sometimes power supplies are needed that will put out several positive and several negative DC voltages. Sometimes a super-low ripple is required, etc. etc.

From this, you can see that there are many jobs for power supplies.

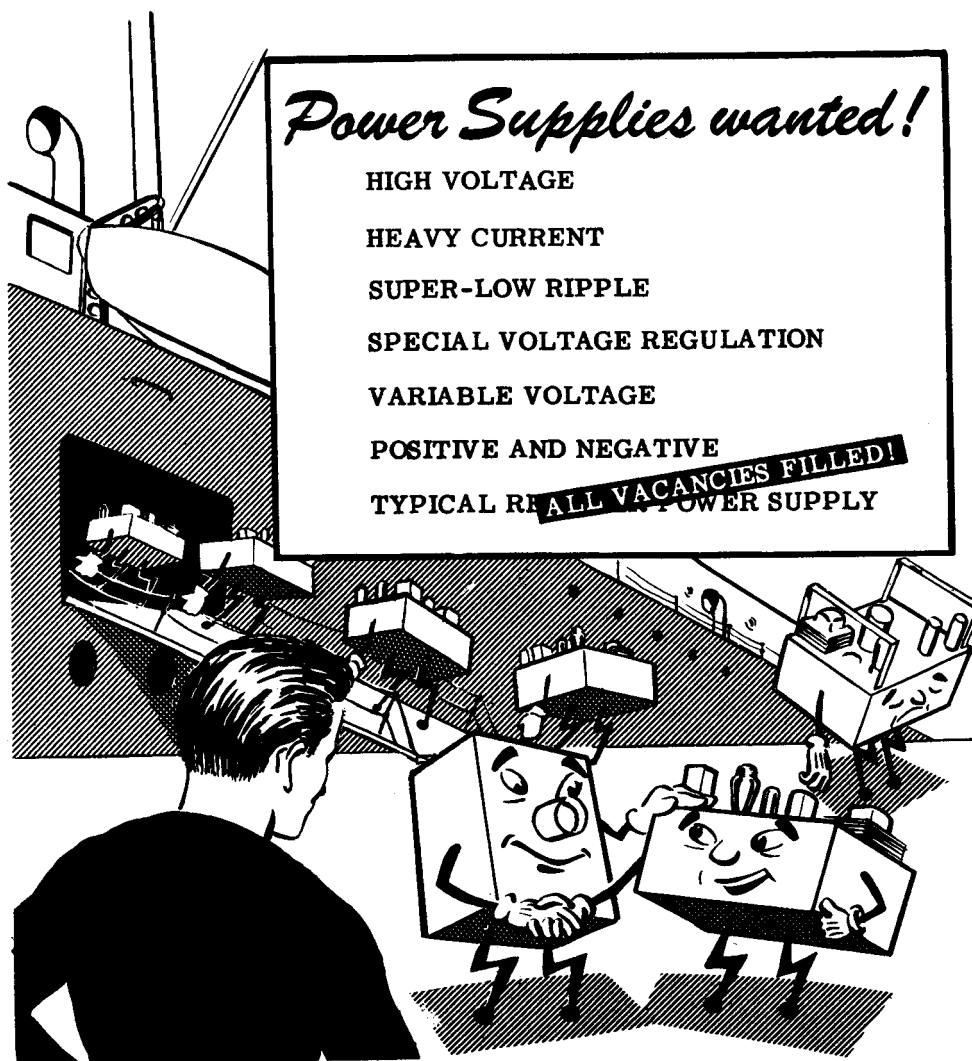

# HALF-WAVE RECTIFIERS—DRY METAL TYPE

## Changing AC to DC

Most electric power is distributed by AC power lines and most electronic equipments contain power supplies which change the AC power line voltage to those DC and AC voltages required by the equipment. To change the AC power line voltage to other AC voltages is relatively simple. A transformer is used to either step up or step down the line voltage, to obtain the required AC voltages.

### POWER SUPPLY TRANSFORMERS STEP UP OR STEP DOWN VOLTAGES AS REQUIRED

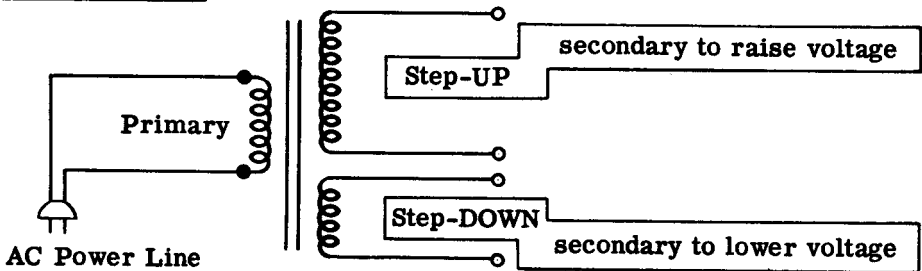

To obtain the required DC voltages, the AC line voltage must be changed to DC. This changing of AC to DC is called "rectification." Devices which change AC to DC are called "rectifiers" and circuits used to change AC to DC are called "rectifier circuits."

Rectifiers are devices which allow current to flow through them in one direction only, acting as a conductor for current flow in one direction and as an insulator for current flow in the other direction. Thus when a rectifier is placed in an AC circuit every other half-cycle of the AC voltage causes current flow in the circuit in that direction for which the rectifier is a conductor. Since the alternate half-cycles are trying to force current through the circuit in a direction for which the rectifier acts as an insulator, no current flows during these alternate half-cycles. As a result, the current flow in a simple rectifier circuit is pulsating DC (alternate half-cycles of AC) rather than a steady DC current flow.

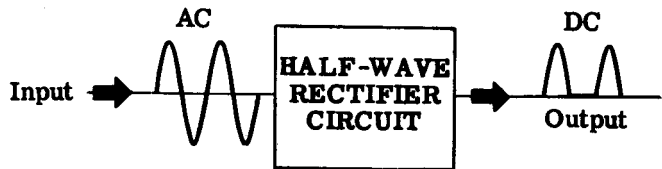
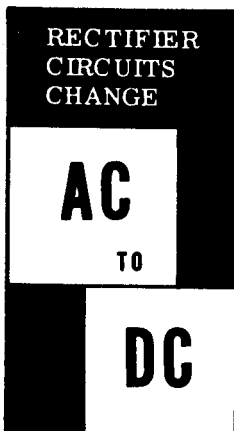

## A RECTIFIER

conducts in one direction.

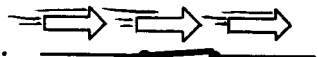

insulates in the other..



# HALF-WAVE RECTIFIERS—DRY METAL TYPE

## Dry Metal Rectifiers

When certain metallic materials are pressed together to form a junction, the combination acts as a rectifier having a low resistance to current flow in one direction and a very high resistance to current flow in the opposite direction. This action is due to the chemical properties of the combined materials. The combinations usually used as rectifiers are copper and copper-oxide, or iron and selenium. Dry metal rectifiers are constructed of disks ranging in size from less than a half inch to more than six inches in diameter. Copper-oxide rectifiers consist of disks of copper coated on one side with a layer of copper oxide while selenium rectifiers are constructed of iron disks coated on one side with selenium.

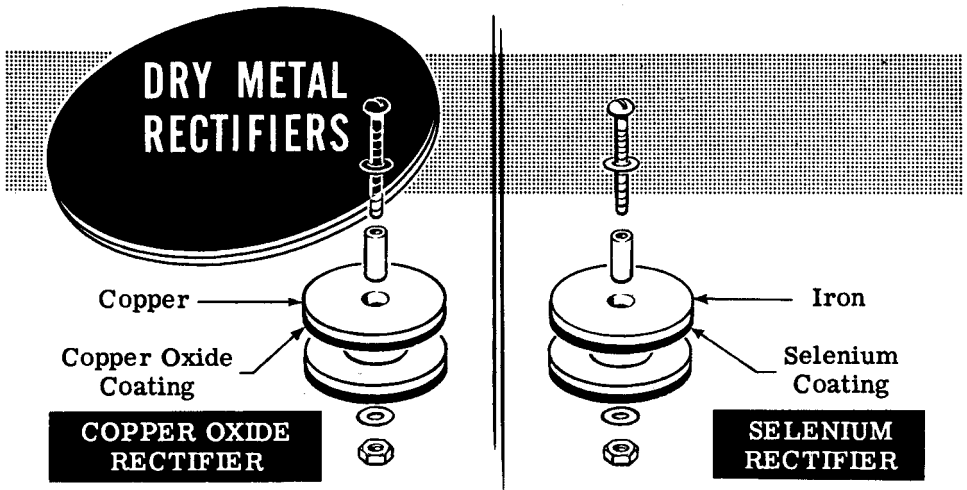

Dry metal rectifier elements (an element is a single disk) are generally made in the form of washers which are assembled on a mounting bolt in any desired series or parallel combination to form a rectifier unit. The symbol shown below is used to represent a dry metal rectifier of any type. Since these rectifiers were made before the electron theory was used to determine the direction of current flow, the arrow points in the direction of conventional current flow but in the direction opposite to the electron flow. Thus the arrow points in opposite direction to that of the current flow as used in electronics.

### DRY METAL RECTIFIER SYMBOL

ELECTRON current flow  
opposite direction from symbol arrow



Dry Metal Rectifiers (continued)

Each dry metal rectifier element will stand only a few volts across its terminals but by stacking several elements in series the voltage rating is increased. Similarly each element can pass only a limited amount of current. When greater current is desired several series stacks are connected in parallel to provide the desired amount of current.

*series stacking increases the*  
**VOLTAGE RATING** of a dry metal rectifier

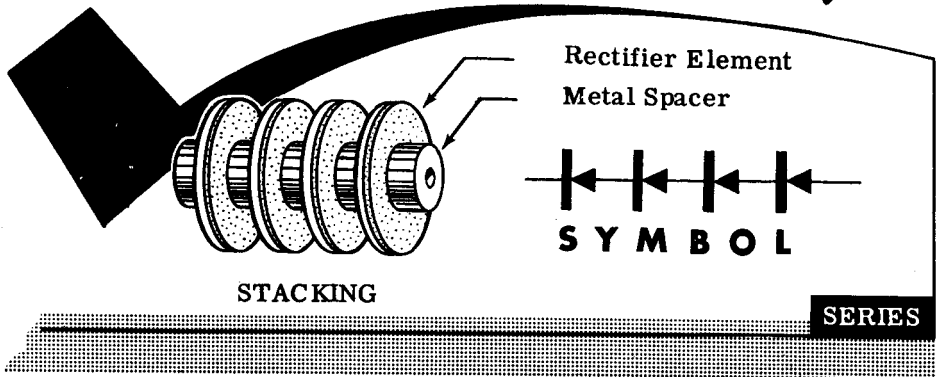

*parallel connection increases the*  
**CURRENT RATING.**

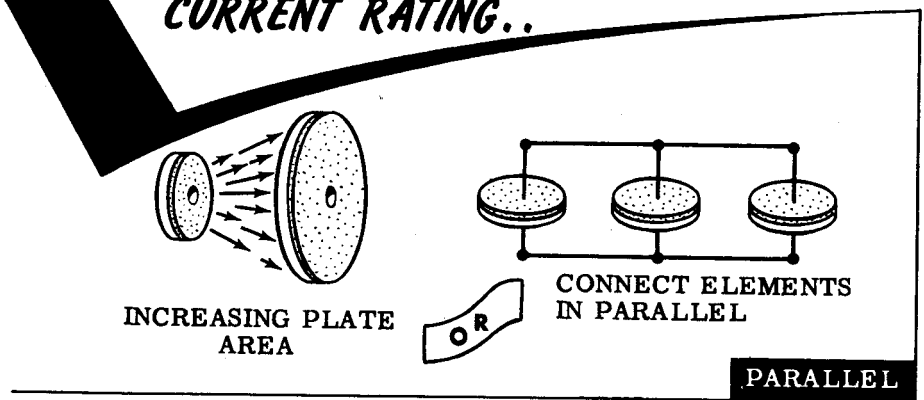

Dry metal rectifiers are very rugged and have an almost unlimited life if not abused. Because of the low voltage rating of individual units they are normally used for low voltages (130 volts or less) since it becomes impractical to connect too many elements in series. By paralleling stacks or increasing the diameter of the disks, the current rating can be increased to several amperes so that they are often used for low voltage-high current applications. Very small units are used to measure AC voltage on a DC voltmeter. Larger units are used in battery chargers and various types of power supplies for electronic equipment.

Dry Metal Rectifiers (continued)

Selenium rectifiers are used in power supplies while copper oxide rectifiers are used in special applications such as meter rectifiers. A typical selenium rectifier of the type used in practical power supplies is illustrated below. It is rated at 130 volts AC and can furnish a maximum of 100 ma. of DC current. The + terminal marking indicates the polarity of the rectifier and is used for identification of leads when connecting the rectifier in a circuit. The positive terminal is sometimes identified by a red dot and the negative terminal by a yellow dot.

**TYPICAL SELENIUM RECTIFIER**

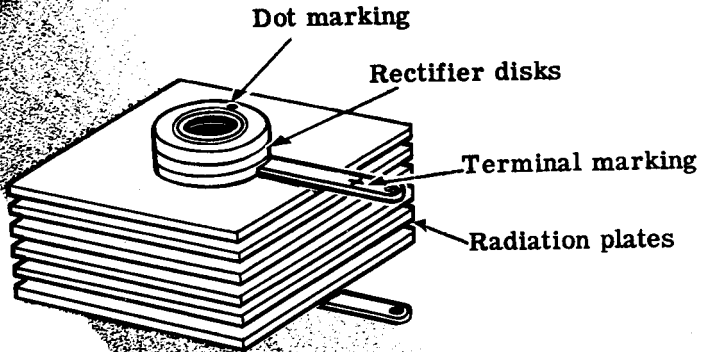

**USED IN POWER SUPPLIES**

A perfect rectifier would offer no resistance to current flow in one direction and infinite resistance in the opposite direction, but such a rectifier is only theoretical. Practical rectifiers used in power supplies actually have low resistance in one direction and very high resistance in the opposite direction. For dry metal rectifiers these resistances can be measured with an ohmmeter.

To test a selenium rectifier the resistance across the terminals is measured in one direction, and then the ohmmeter leads are reversed to measure the resistance in the opposite direction. If the high reading is 10 or more times as large as the low reading, the rectifier is in good condition.

## HALF-WAVE RECTIFIERS—DRY METAL TYPE

### A Half-Wave Rectifier Circuit

A basic half-wave rectifier circuit consists of a rectifier connected in series between the AC voltage source and the circuit load resistance. The rectifier permits current to flow only during the positive half cycles of the applied AC voltage and the circuit current then is pulsating DC. In the circuit illustrated, the applied line voltage is 117 volts, 60 cycles AC and current flows only for one half of each cycle. Thus the current flow through the circuit is in pulses at the rate of 60 pulses per second. Actually there is a slight current flow in the opposite direction during the negative half cycles but it is so small that it is considered to be zero.

This simple circuit illustrated is the basic circuit used to change AC to DC. When connected as shown, the DC voltage across the load resistor is positive at the end which connects to the rectifier and negative at the other end. The negative terminal of the load resistor is normally grounded to the chassis in a power supply.

#### HALF-WAVE RECTIFIER CIRCUIT

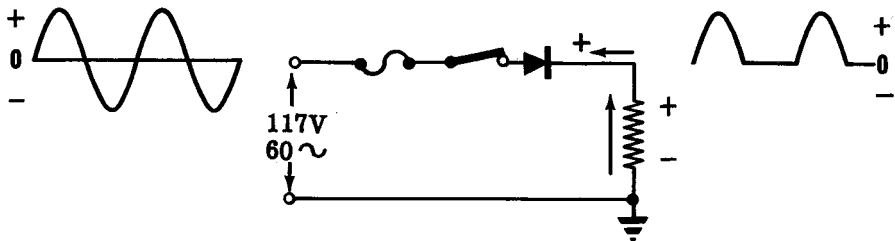

To reverse the polarity of the DC voltage obtained, the rectifier is reversed. This allows current to flow only on the opposite half cycles as compared to the previous circuit. This circuit is used to obtain a negative DC voltage with respect to ground. The grounded end of the load resistor is positive.

#### REVERSING THE POLARITY OF OUTPUT VOLTAGE

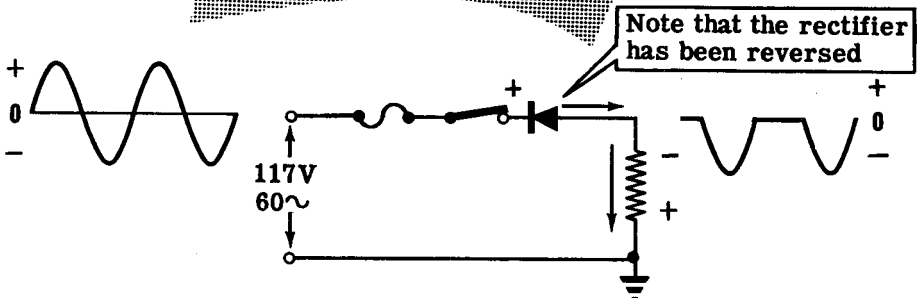

# HALF-WAVE RECTIFIERS—DRY METAL TYPE

## Review

**RECTIFICATION** — When a device called a rectifier is placed in series with an AC circuit, it permits current to flow only in one direction, changing the applied AC voltage to pulsating DC. Rectification is the changing of AC to DC.

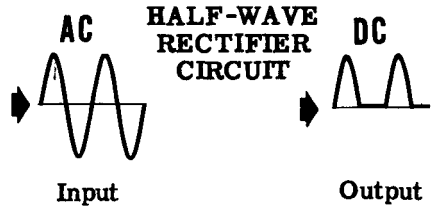

**DRY METAL RECTIFIERS** — A rectifier consisting of two unlike metallic substances pressed together, which allows current flow in one direction only. Copper-oxide and iron-selenium combinations are usually used to construct dry metal rectifiers.

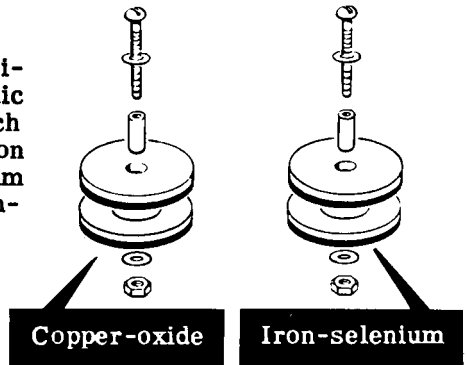

**HALF-WAVE RECTIFIER CIRCUIT** — A rectifier connected in series between an AC voltage source and the circuit load resistance. The rectifier changes the applied AC to a DC output voltage across the load resistance.

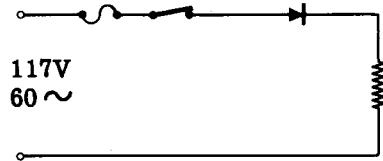

**RECTIFIER CIRCUIT WAVEFORMS** — If the applied voltage is an AC sine wave, the output waveform consists of half cycles of the applied AC voltage. This output waveform is a pulsating DC voltage.

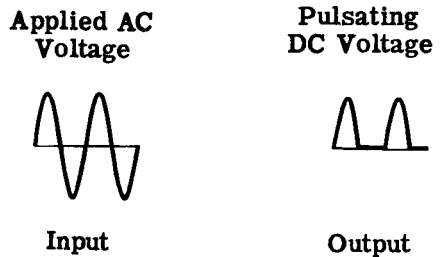

# HALF-WAVE RECTIFIERS—VACUUM TUBE TYPE

## Vacuum Tubes

Dry metal rectifiers are used in many power supplies to change AC to DC but they are limited as to voltage and current rating. They are not normally rated at voltages greater than 130 volts AC. Low voltage units rated at 10 volts or less have a high current capacity, greater than 1 ampere, while the current capacity of higher voltage units is much less than 1 ampere.

Because of the voltage and current limitations of dry metal rectifiers, another type of rectifier, the diode vacuum tube, is often used in power supplies. As a rectifier, the diode vacuum tube operates in the same way as a dry metal rectifier, acting as a good conductor of current in one direction and as an insulator in the other direction. The diode vacuum tube also has many other uses in electronics which you will find out about later.

**VACUUM TUBES ARE USED AS  
RECTIFIERS**

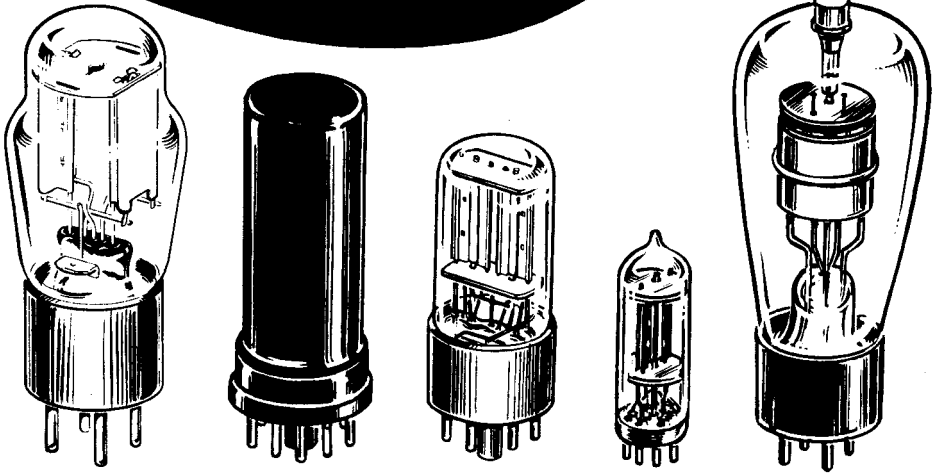

**VACUUM TUBE RECTIFIERS  
DO THE SAME JOB AS  
DRY METAL RECTIFIERS**

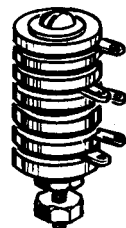
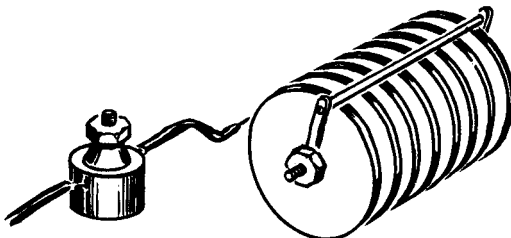
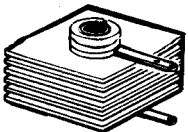

## HALF-WAVE RECTIFIERS—VACUUM TUBE TYPE

### The Discovery of the Diode

The principle on which a diode is based was discovered some 70 years ago—before anything was known about electrons.

Thomas Edison was working on an experiment with his incandescent lamps in which a carbon filament was used. The filaments which he used broke too easily as they were constructed of thin threads or filaments of carbon.

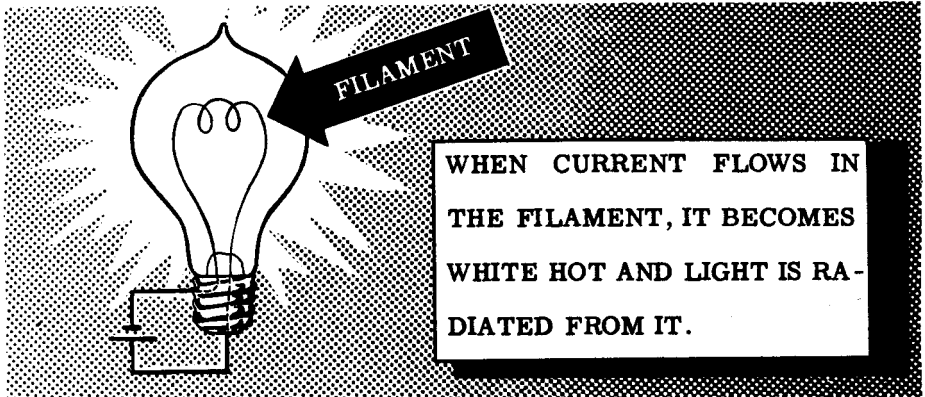

In an effort to lengthen the life of his light bulbs, Edison constructed a metal support which he connected to the fragile filament by insulated sections. For some unknown reason, he connected the metal support to the positive side of a battery and the filament to the negative side. To his surprise, he noticed that a current was flowing.

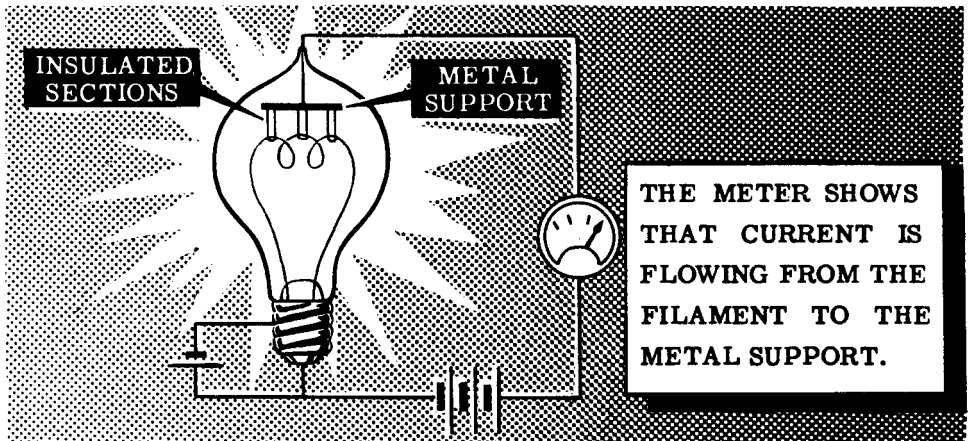

Since nothing was known about electrons, Edison could not understand or see any importance in his discovery and it took 21 years before Fleming, a British scientist learned the significance of this flow of electrons. Because he observed that current could flow only in one direction, Fleming called his vacuum tube a "valve." In fact, vacuum tubes are still called "valves" by the British.

# HALF-WAVE RECTIFIERS—VACUUM TUBE TYPE

## How a Diode Tube Works

The diode vacuum tube is like a game of baseball in which control is the important thing. An understanding of how a diode vacuum tube controls the flow of current is required to understand how a diode tube works as a rectifier.

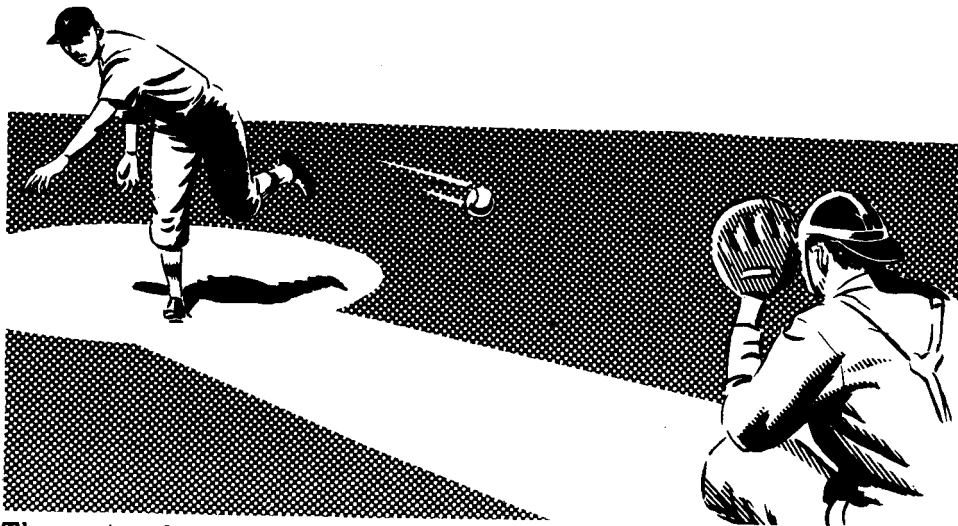

The parts of a vacuum tube which directly control the flow of current are called elements. A heated element which gives up electrons is called the cathode. The plate is a cylindrical element surrounding the cathode which attracts electrons when it is positively charged. The cathode is heated by a filament of resistance wire called a heater, which is not considered to be an element since it does not directly control the amount of current flow from cathode to plate. A vacuum tube of the type illustrated is called a diode because it has only two elements, a cathode and plate.

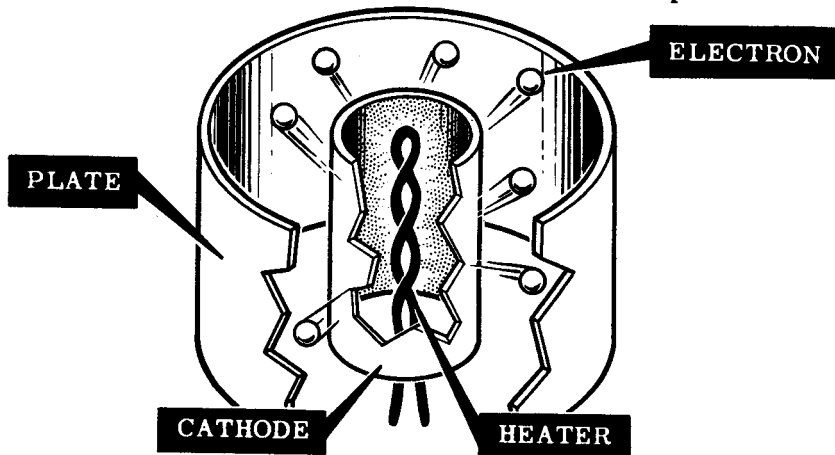

In addition to preventing the filament from burning, removing the air from the tube prevents the air molecules from interfering with the flow of electrons from cathode to plate. Sometimes the air is replaced by an inert gas which aids rather than opposes the electron flow.

# HALF-WAVE RECTIFIERS—VACUUM TUBE TYPE

## Electron Emission

The basic requirement of a diode vacuum tube is that there has to be a source of freely moving electrons which can be used to give us current flow. Of course, electrons are found in every atom of every substance but we still need a method of driving them out of the substance to make them freely moving.

In Edison's set-up, the intense heat of the filament did the trick, and heat is used to do it in practically all the vacuum tubes you will see. Driving electrons out of a substance by heat is known as "thermionic emission."

In the illustration, you will notice that the cathode is a cylinder or "sleeve" which surrounds, but does not touch, the filament. The filament is heated by the current flowing in it and the cathode is heated because it is so close to the filament. This arrangement of parts is known as an indirectly heated cathode.

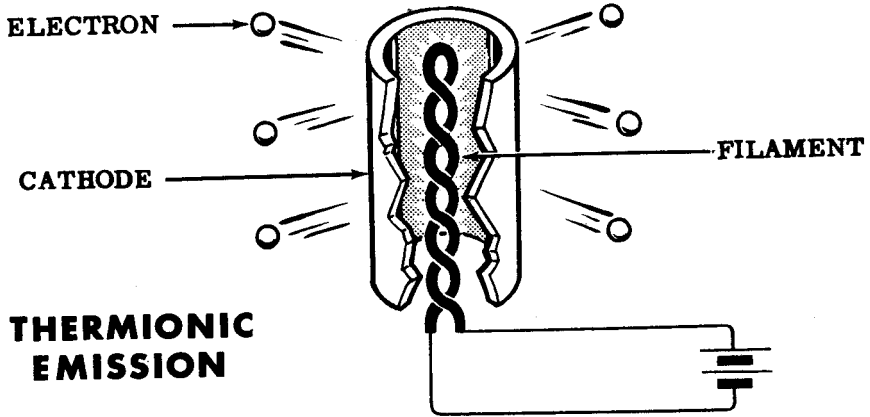

Some tubes such as the Fleming's Valve or the type 80 rectifier tube have what is known as directly heated cathodes, which means that there is no sleeve around the filament and the filament is itself the electron emitter.

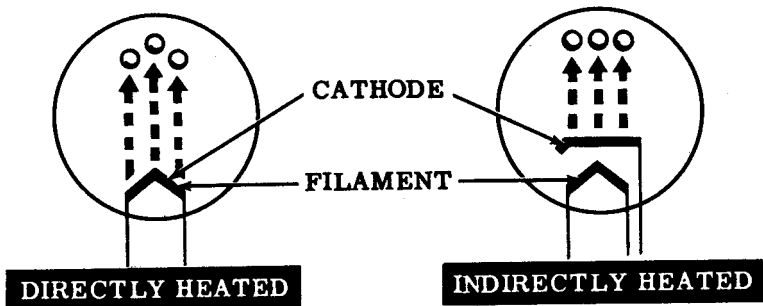

Because they can emit many more electrons than the indirectly heated type, directly heated cathodes are used in vacuum tubes designed for power supplies which supply high currents. Indirectly heated cathodes are more frequently used in low-current power supplies. Having the heater (filament) and the electron emitter (cathode) separate in an indirectly heated tube allows for the separation of the filament's and the cathode's electrical circuits.



## HALF-WAVE RECTIFIERS—VACUUM TUBE TYPE

### Electron Emission (continued)

If the cathode and filament were alone in the glass tube, the emitted electrons would form a cloud called "space charge" around the cathode. Like the electrons in it, the space charge is negatively charged and therefore tends to repel other electrons and to keep more electrons from being emitted by the cathode. After a while, a balance would be reached between the tendency of the cathode to emit electrons and that of the space charge to repel them.

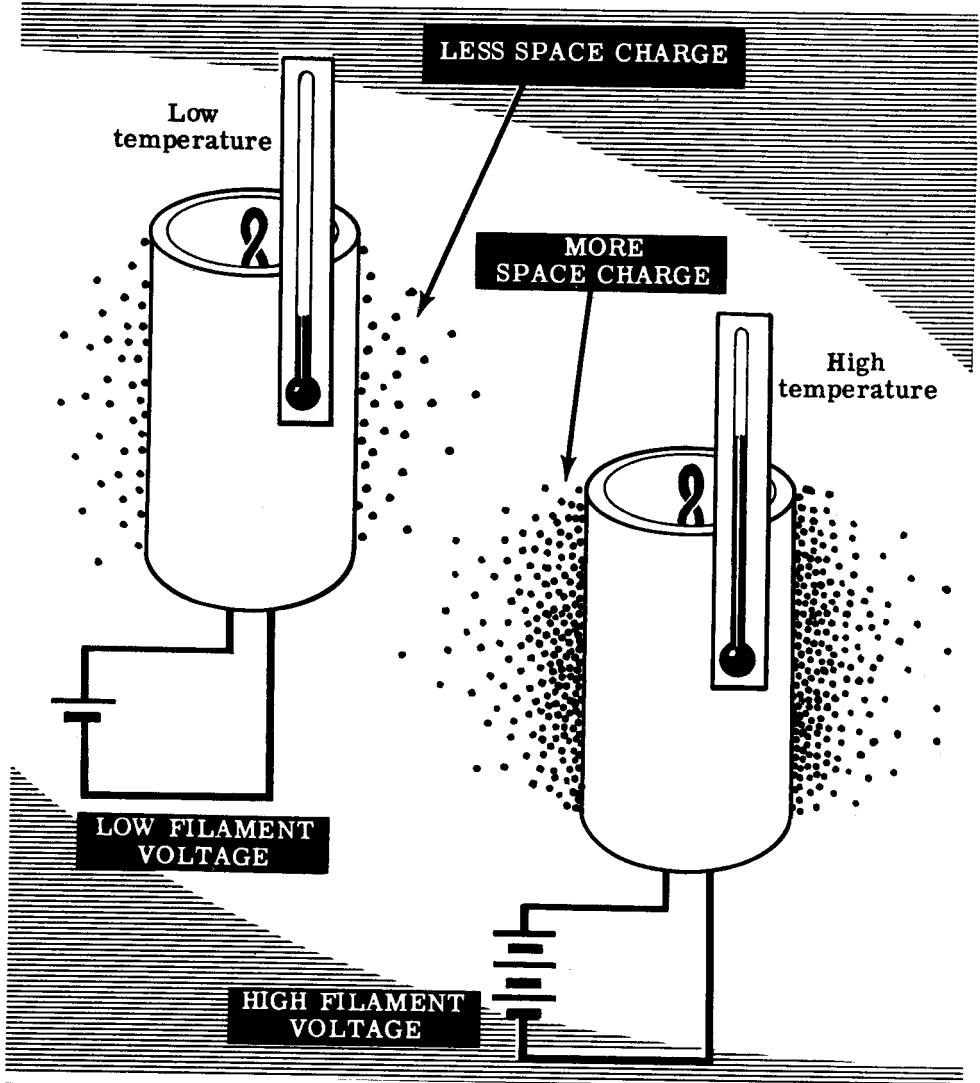

To increase the emission of electrons, you would have to raise the cathode's temperature by increasing the filament current. If, on the other hand, the cathode's temperature is lowered, the space charge will force some of its electrons to re-enter the cathode, resulting in decreased emission. The heater voltage for a tube is usually fixed. Various types of tubes operate with AC or DC heater voltages in the range from 1.25 to 117 volts.

# HALF-WAVE RECTIFIERS—VACUUM TUBE TYPE

## How Current Flows in a Diode

When a positively charged plate is placed around the cathode, the electrons are attracted from the space charge. The number of electrons which flows to the plate depends on the plate voltage with respect to the cathode.

When the plate is more negative with respect to the cathode, no current flows from cathode to plate because the negative plate repels the electrons. Current cannot flow from the plate to the cathode, since the plate does not emit electrons.

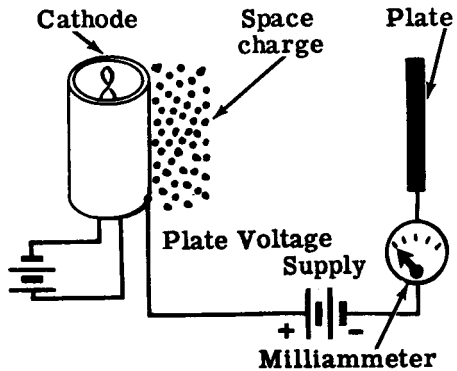

When the plate and cathode are at the same potential, the plate neither attracts nor repels electrons — the current is still zero.

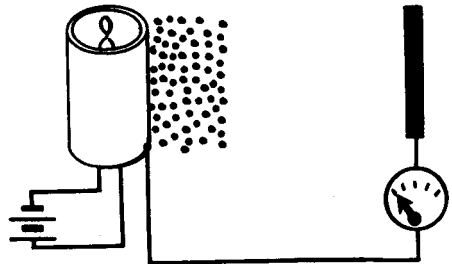

As soon as the plate becomes positive with respect to the cathode, current will flow from the space charge.

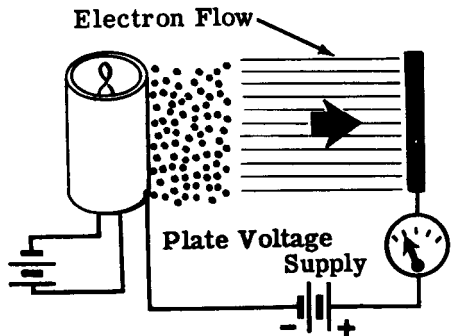

If this plate voltage is doubled, the current which flows is also doubled. This is the normal way for a diode to work: as long as the plate is positive with respect to the cathode, every change in plate voltage causes a corresponding change in plate current.

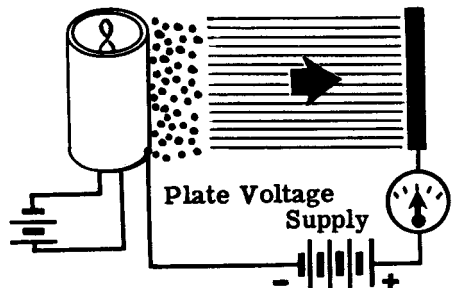

## HALF-WAVE RECTIFIERS—VACUUM TUBE TYPE

### How Current Flows in a Diode (continued)

Now that the plate is very positive with respect to the cathode, the milliammeter indicates that a very large current is flowing. The plate is attracting the electrons as fast as the cathode can emit them.

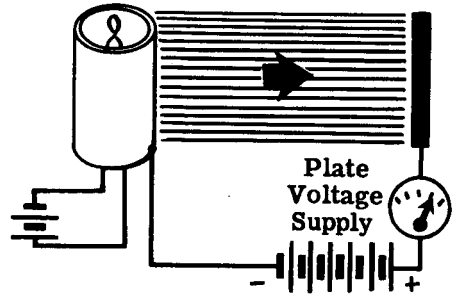

At this point, a further increase in plate voltage does not result in any additional current. The current does not increase because the cathode is emitting all the electrons it can. It is NOT normal to operate a diode at such a high plate voltage that changes in plate voltage do not produce changes in plate current.

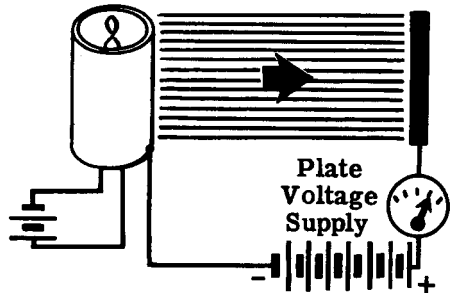

If we now increase the filament voltage above its normal value, we enable the cathode to emit more electrons and, with the same plate voltage as before, we observe that a larger plate current is flowing.

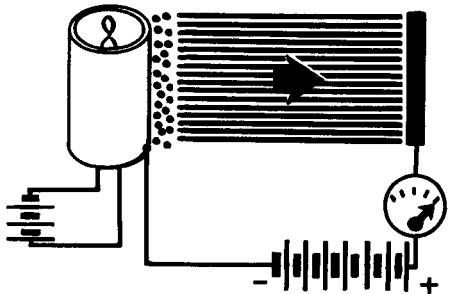

If we had reduced the filament voltage, the current would have decreased because the cathode could not emit as many electrons as before. In practice, the filament voltage is not varied. Changes in plate current are achieved by varying the plate voltage as already described. However, after a tube has been used for some time, the cathode's emission decreases and the result is the same as if the filament voltage were decreased.

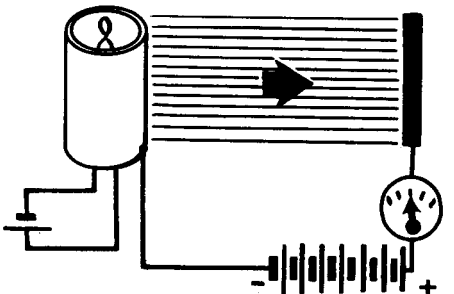

# HALF-WAVE RECTIFIERS—VACUUM TUBE TYPE

## The Rectifier Tube

The process of changing AC into DC is called "rectification." To change AC to DC a device must be used which will permit current flow in one direction only. A diode vacuum tube is such a device, permitting current to flow only from the cathode to the plate. Current does not flow from the plate to the cathode because the plate is not heated and therefore does not emit electrons. Since the plate will not emit electrons but will, when positive, attract electrons from the cathode space charge, the diode is a conductor only from cathode to plate and not from plate to cathode.

Any diode will rectify AC into DC but some are especially designed for use in power supplies and these are referred to as rectifier tubes. A typical rectifier tube with its schematic symbol is illustrated below. It is a twin diode (two diode tubes in the same glass envelope) and has a directly heated cathode. A filament which also acts as the cathode is suspended inside each metal plate and the two filaments are internally connected in series.

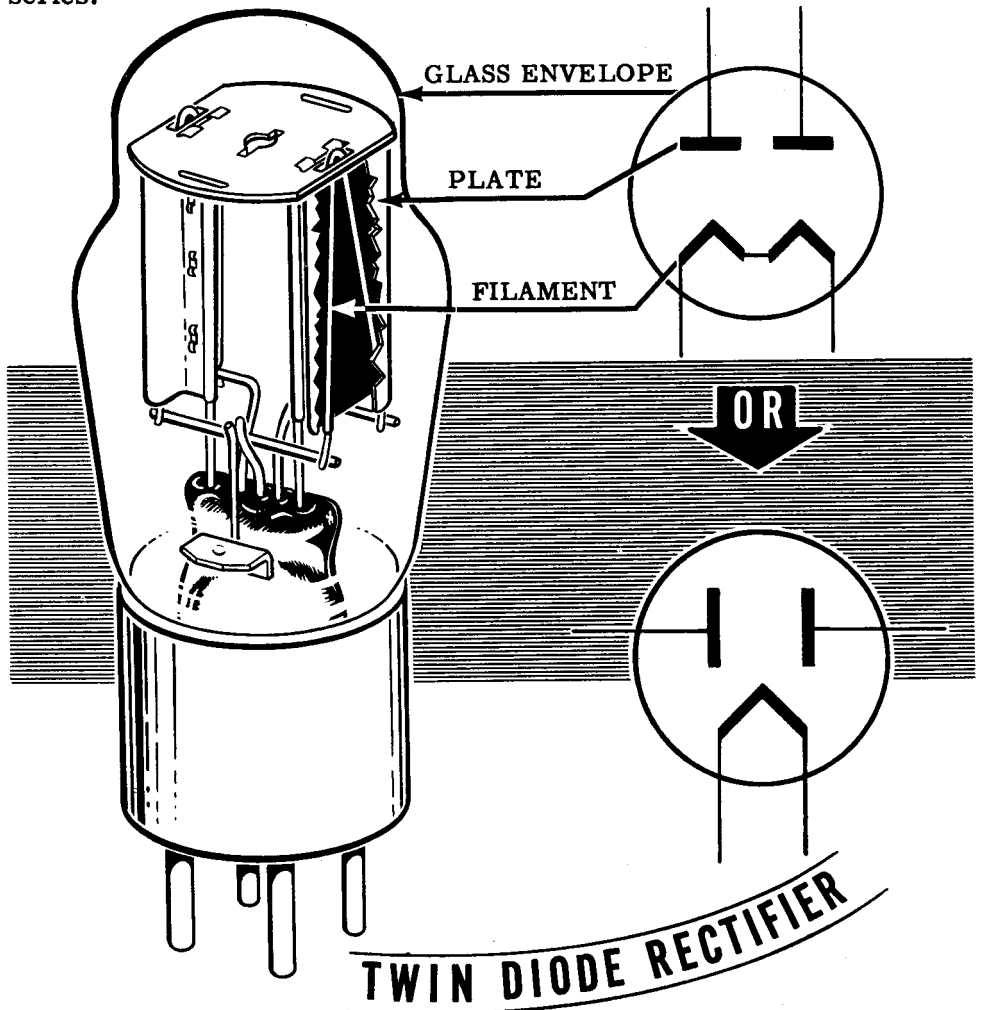

# HALF-WAVE RECTIFIERS—VACUUM TUBE TYPE

## The Rectifier Tube (continued)

Some rectifier tubes have indirectly heated cathodes. A typical tube of this type is illustrated below. Vacuum tubes of all types are identified by number and the numbering system, which you will find out about later, indicates certain characteristics of the tube. The rectifier illustrated on the preceding sheet is a type 80 tube and the one illustrated below is a 117Z6-GT.

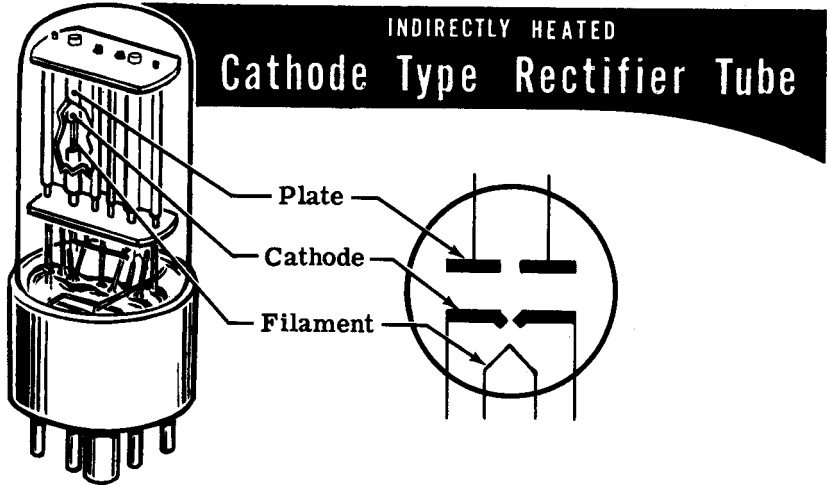

Vacuum tubes are constructed with a plug-in base which fits into a socket. The socket is permanently wired into the circuit and the tube is removable and easily replaced. Vacuum tubes have a relatively short life as compared to other components used in electronic equipment and a method of easy replacement is required.

Although many special types of sockets are used, most of the vacuum tubes used in electronics require one of the eight sockets illustrated below. One method of classifying tubes is according to the socket required. The pin numbering system is also illustrated and refers to the bottom side of the socket since the circuit wiring is done on that side.

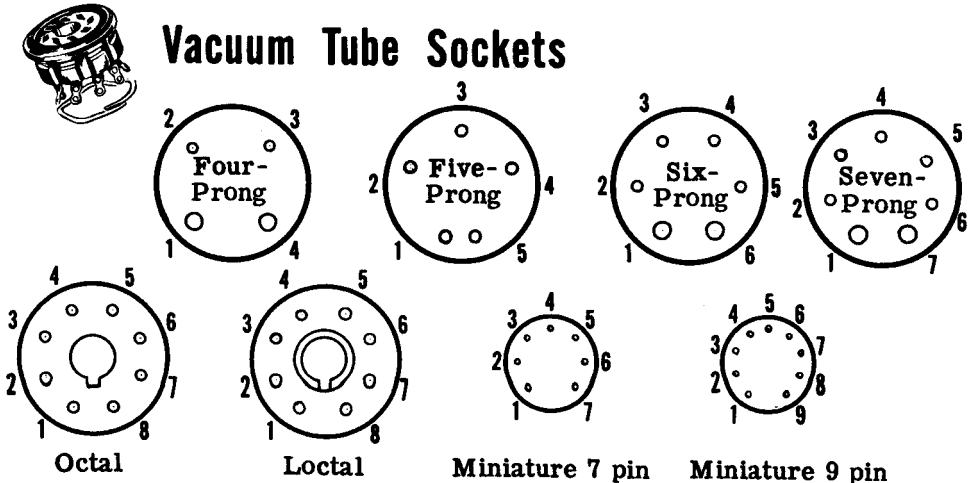

# HALF-WAVE RECTIFIERS—VACUUM TUBE TYPE

## The Rectifier Tube (continued)

In an indirectly heated tube, the cathode and filament are separate structures and are connected to separate circuits. In a directly heated tube, the filament replaces the two structures, and is connected to two circuits. The filament wires are connected across a low voltage of about 5 volts which heats the filament and causes thermionic emission. In addition, one of the filament wires is connected to the circuit to which a cathode would be connected if the tube were indirectly heated.

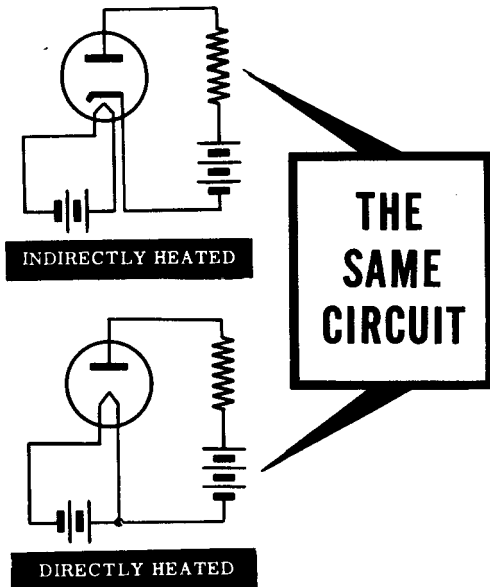

There are two different ways of using a rectifier tube which has two plates and one filament. If both plates are connected together, the tube is acting the same as one diode because, in effect, you have only increased the plate area.

The other way is to connect the plates separately to different parts of the circuit. In this way the plates will not be at the same voltage and the effect is the same as using two separate diodes with the cathodes (or filaments) connected together. No matter how the connections are made, each plate will draw current only when it is positive with respect to the filament.

**TWO PLATES CONNECTED TOGETHER**

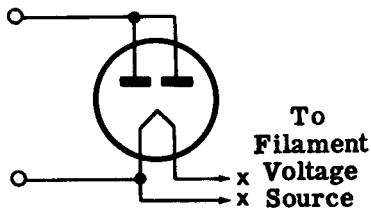

ACT LIKE . . .

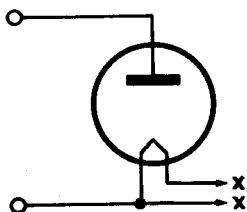

**TWO PLATES CONNECTED SEPARATELY**

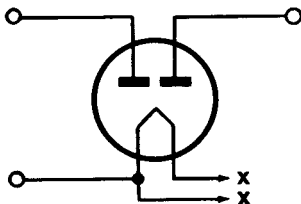

ACT LIKE . . .

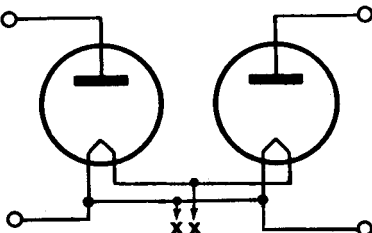

# HALF-WAVE RECTIFIERS—VACUUM TUBE TYPE

## A Half-Wave Vacuum Tube Rectifier Circuit

A diode rectifier tube may be used in the half-wave rectifier circuit in place of a selenium rectifier if there is a voltage source available to supply the filament current required by the rectifier tube. The basic rectifier circuit using a vacuum tube rectifier is illustrated below. If the plate and cathode connections are reversed the polarity of the DC output voltage is reversed.

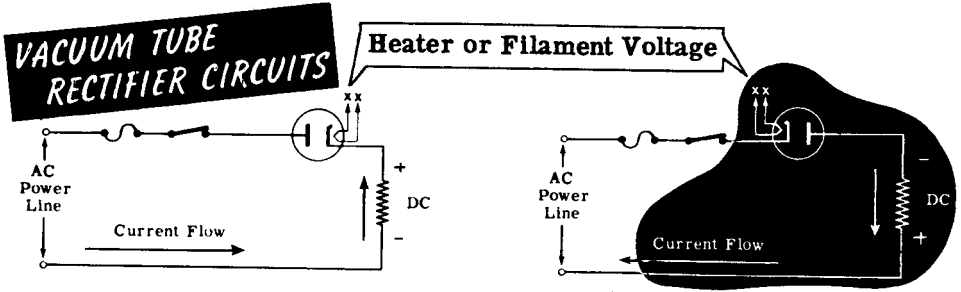

The rectifier tube filament circuit requires an additional source of filament voltage not required by the selenium rectifier—otherwise the operation of the circuit is identical to that of the basic dry metal rectifier circuit. Rectifier tube filaments are rated in volts and amperes so that the filament must be connected to a voltage source of the rated voltage and current. Filament or heater voltages are normally obtained from a step-down transformer or by using a series resistor to drop the line voltage to the correct value. Tubes having heaters rated at the same current are sometimes connected in series across the AC power line. Some rectifier tube heaters are rated at 117 volts and may be connected directly across the AC power line.

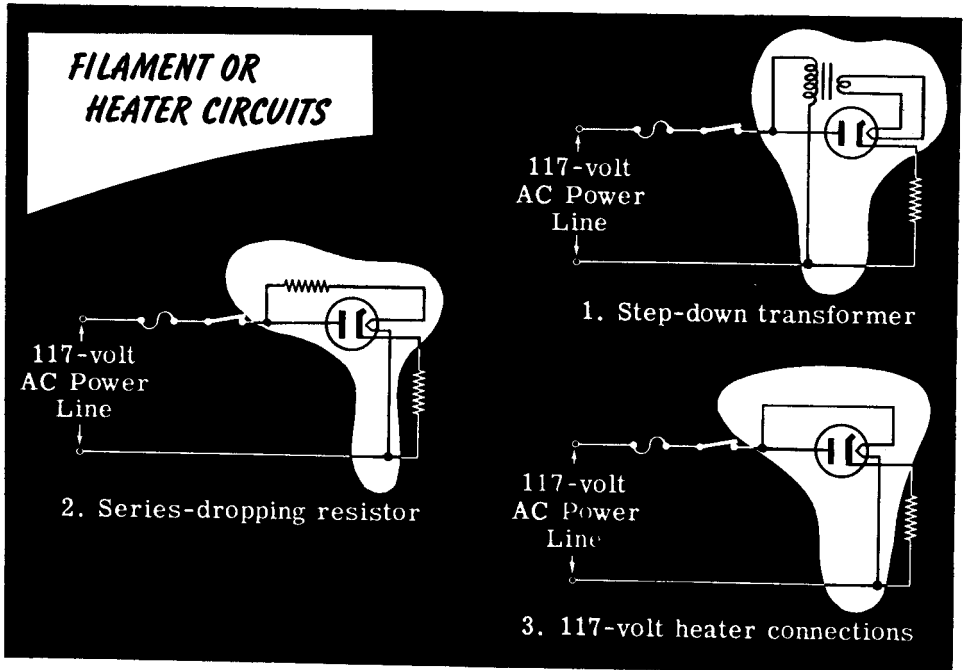

# HALF-WAVE RECTIFIERS—VACUUM TUBE TYPE

## Vacuum Tube Circuit Wiring

In electronic circuit diagrams, vacuum tubes like other parts are represented by symbol. Usually the symbol shows only the connection of the tube elements to various parts of the circuit. To wire the socket, it is necessary to refer to a tube manual which shows the pin numbers of each tube element. In the illustration below a 117Z6-GT is shown in the circuit diagram with the plates and cathodes connected together to form a single diode. The tube base diagram of the type found in a tube manual and the actual wiring connections for the socket are shown below.

### WIRING A 117Z6-GT TUBE SOCKET

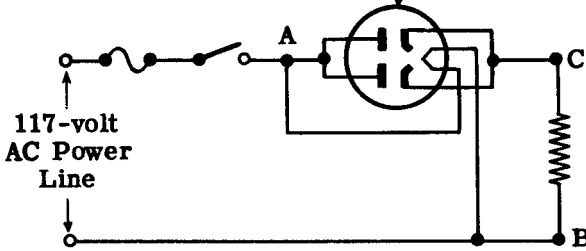

Base diagram from tube manual

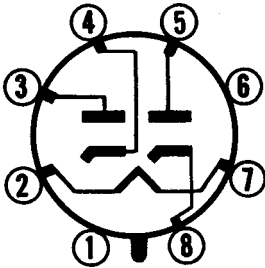

Actual socket wiring

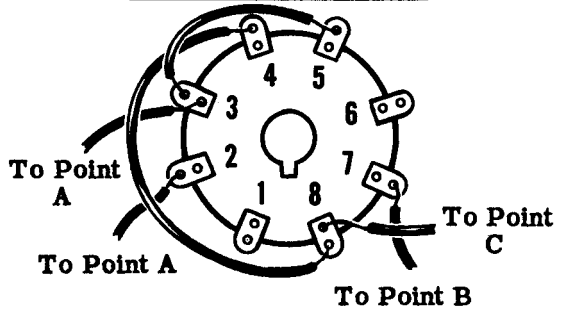

There is a wide variation in the method of representing a vacuum tube in a circuit diagram and tube pins as well as elements are sometimes indicated.

### SOME METHODS USED TO SHOW VACUUM TUBES IN CIRCUITS

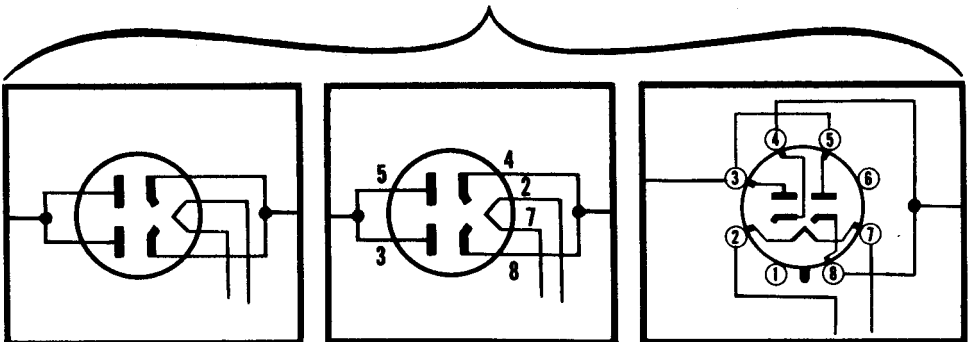



## HALF-WAVE RECTIFIERS—VACUUM TUBE TYPE

### The Gas-Filled Diode

You have already learned about two types of rectifying devices—the high vacuum diode and the dry metal rectifier. You have been told that the dry metal type could be used in the same circuit as the diode and the circuit would work the same way. Now you are going to find out about a third type of rectifying device which is used in similar circuits and works in very much the same way.

Not all diodes are vacuum tubes. In some, all the air is removed from the tube and, before the tube is sealed, a small amount of chemically-inactive gas is placed in it. Then, instead of a high vacuum, the diode would have a low pressure gas in it. One common gas tube has a small quantity of mercury placed in it and, because of the low pressure around it, the mercury vaporizes. The mercury vapor acts the same way as an inert gas such as neon or argon.

The symbol for a gas tube or mercury vapor tube differs from the symbol of a high vacuum tube only by the round dot which indicates the presence of the gas. Any time you see that dot on a tube symbol, you know that the tube is of the gas-filled type.

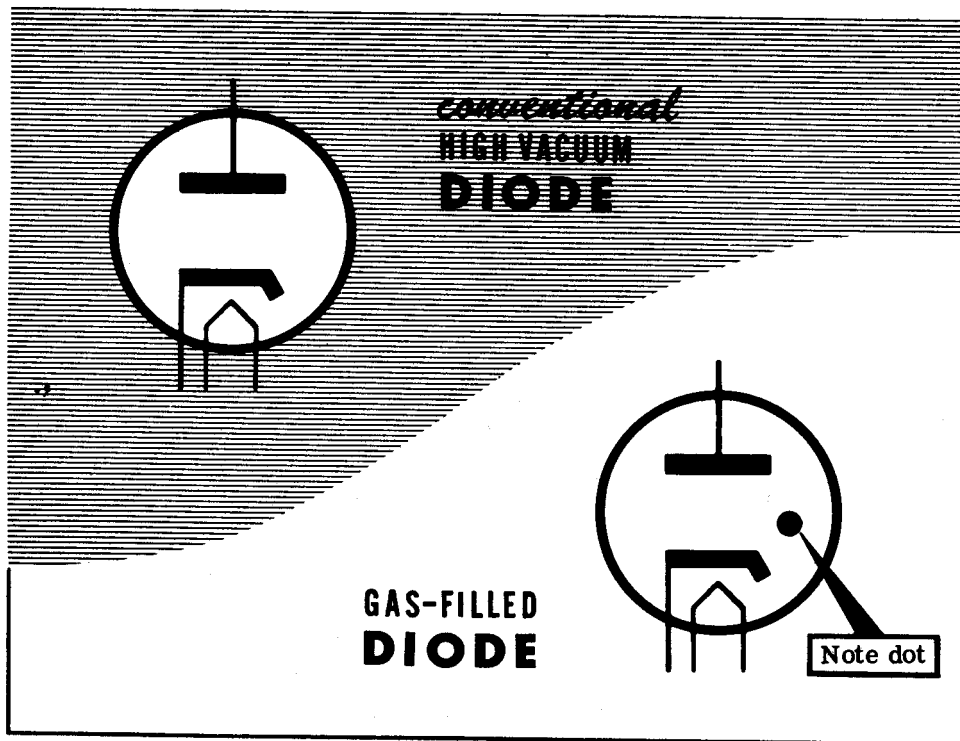

As you can see in the illustration, a gas tube has the same basic type of heater and cathode arrangement as the conventional diode. Many gas tubes have directly heated cathodes similar to the one in the type 80 high vacuum rectifier diode. Furthermore, the purpose of the cathode is the same in both types of tubes—to emit electrons.

## HALF-WAVE RECTIFIERS—VACUUM TUBE TYPE

### The Gas-Filled Diode (continued)

A diode acts just like an ordinary resistor when the tube is conducting. This is its disadvantage. Let's see why.

When you draw only a little current from a power supply which has a high vacuum rectifier, there is only a small voltage drop across the diode. As a result, the B+ voltage is very high. On the other hand, when a large current is taken from the power supply, the drop across the tube becomes very large and the B+ voltage drops way down. For this reason, a power supply using a high vacuum diode does not have good regulation. Regulation, is a measure of how well a power supply can maintain a constant output voltage as the load current varies from zero up to rated current. Because of its poor regulation, high vacuum rectifiers, aren't in power supplies which must deliver large load currents.

WHEN THE  
LOAD  
CURRENT  
GOES UP ....

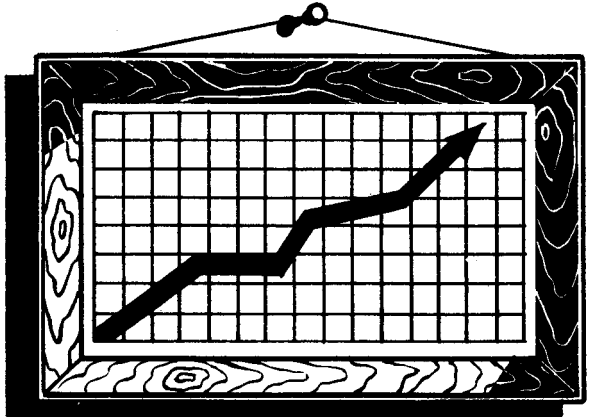

THE  
OUTPUT  
VOLTAGE  
(B+)  
GOES DOWN

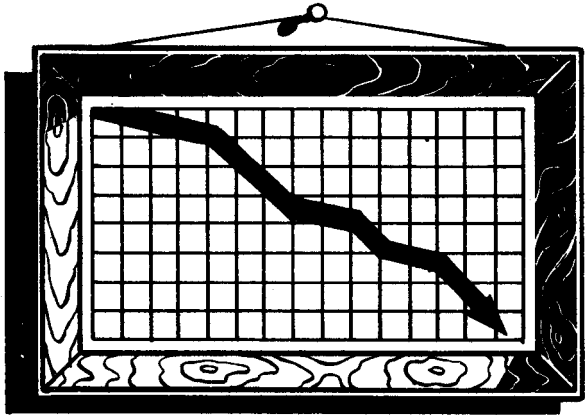

A POWER SUPPLY USING A  
HIGH VACUUM DIODE  
HAS Poor Regulation

## HALF-WAVE RECTIFIERS—VACUUM TUBE TYPE

### The Gas-Filled Diode (continued)

In a gas diode, electrons flow from the cathode to the plate just as in any diode. These electrons passing through the gas at fairly high speeds, knock one or more electrons out of the gas atom, leaving the atom with a + charge, and the gas is said to be ionized. The positive ions (the atoms which have had electrons knocked out of them) drift over to the cathode and pick up the electrons they lack. Some time later, another fast moving electron will knock some electrons out of the neutral atom, thus ionizing it again. In this way the gas always contains some ionized atoms.

Ionized gas has an amazing property. When a little current flows through the tube, there is a voltage drop across the tube of about 15 volts. When a lot of current passes through the tube, the voltage drop across the tube is still about 15 volts. There is an extremely small change in this voltage drop as the tube current varies over a wide range.

You can see that if the voltage across the gas tube is constant at different load currents, the B+ voltage will not change as much as it did in a power supply using a high vacuum tube. For this reason, the gas tube causes the power supply to have a better regulated output voltage than did the high vacuum tube.

You will find gas rectifiers used on any power supply which must deliver large load currents. Because of the low drop across the gas rectifier, the power supply will be much more efficient than if a high vacuum tube had been used.

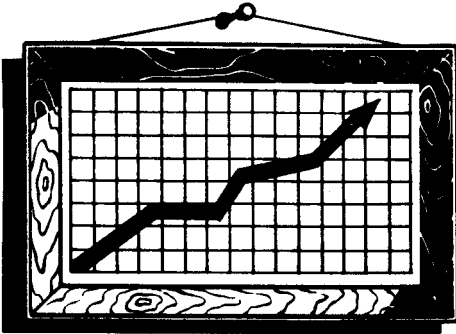

WHEN THE  
LOAD  
CURRENT  
GOES UP ....

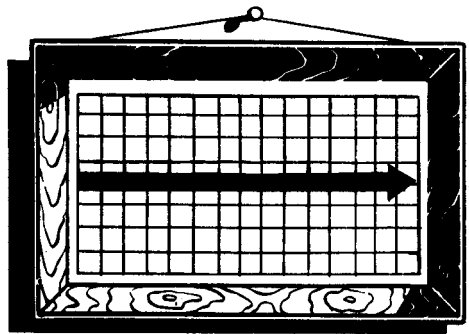

THE  
OUTPUT  
VOLTAGE (B+)  
REMAINS CONSTANT



A POWER SUPPLY USING A  
GAS-FILLED DIODE  
HAS Good Regulation

# HALF-WAVE RECTIFIERS—VACUUM TUBE TYPE

## Review of Vacuum Tube Rectifiers

**DIODE VACUUM TUBE** — A two element vacuum tube consisting of a heated cathode and a metal plate enclosed in a glass envelope or tube from which the air has been removed.

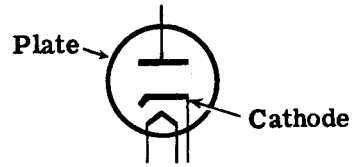

**ELECTRON EMISSION** — The action of the cathode in giving up electrons when the cathode is heated.

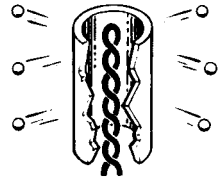

**SPACE CHARGE** — The negative charge in the area surrounding the cathode caused by the emission of electrons from the cathode.

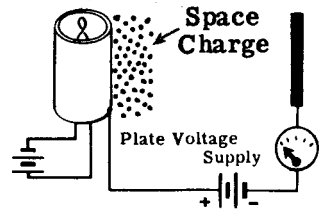

**RECTIFIER TUBE** — A vacuum tube made especially for use as a rectifier.

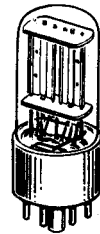

**FILAMENTS** — Fine wire heater used to heat the cathode in a vacuum tube. In directly heated cathode tubes, the filament and cathode are the same wire while in indirectly heated cathode tubes, the filament is called a heater and is used only to heat the cathode.

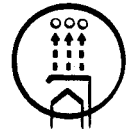
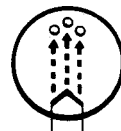

**BASIC VACUUM TUBE RECTIFIER CIRCUIT** — A diode vacuum tube connected in series with an AC voltage source to change AC to DC.

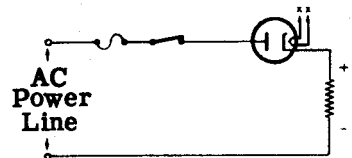

# HALF-WAVE RECTIFIERS—TRANSFORMER TYPE

## Transformer Type Power Supplies

The two basic rectifier circuits which have been discussed are used to change the 117 volt AC line voltage to DC. These rectifier circuits are often used for inexpensive power supplies when it is not necessary to isolate the rectifier circuit from the AC power line or to obtain DC voltages greater than 120 volts.

By adding a transformer to the circuit between the power line and the rectifier, the AC voltage can be increased or decreased resulting in a corresponding rise or fall of the DC output voltage. Also the output of the rectifier circuit will be completely isolated from the power line, and various filament voltages may be obtained by using additional secondary windings on the transformer. Because of the different voltages required and the need for isolating circuits in electronic equipment, most power supplies are of the transformer type. Several typical power supplies of this type are shown below.

### Transformer Type Power Supplies

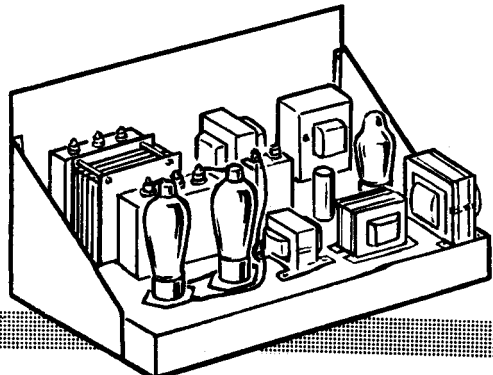
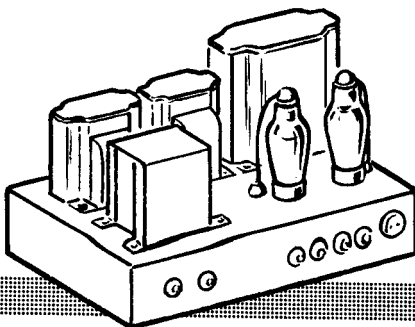
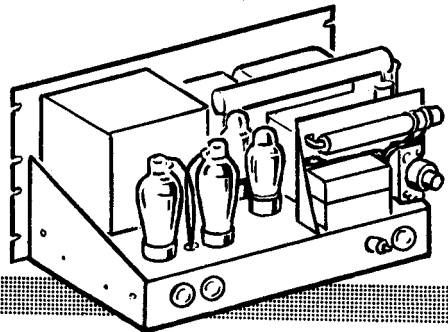
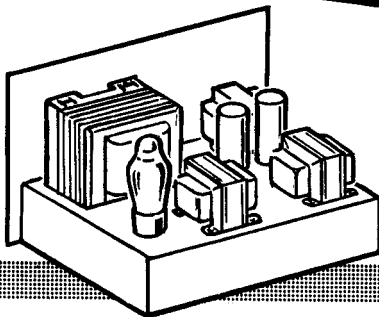
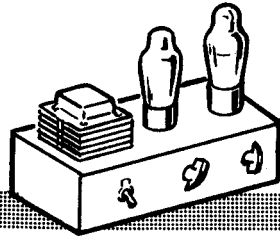

# HALF-WAVE RECTIFIERS—TRANSFORMER TYPE

## The Diode in a Transformer Type Circuit

All rectifiers, including the half-wave rectifier, change an AC voltage into a pulsating DC voltage. Each rectifier accomplishes this by allowing current to flow in the circuit in only one direction, and only slight differences exist in different rectifier circuits. You are going to see how the half-wave transformer type rectifier circuit makes the change from AC to pulsating DC.

The rectifying action of this circuit depends on the operation of a diode, the rectifier tube. The theory of operation of the diode has already been covered but, in order to understand the operation of the diode in the transformer type circuit, you should review these two facts.

1. The diode allows electrons to pass through it only when its plate is positive with respect to its cathode.

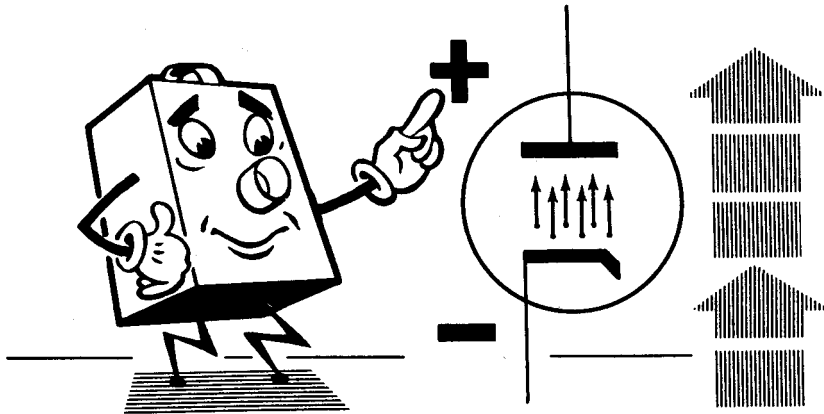

2. The diode does not allow electrons to flow through it when the plate is negative with respect to the cathode.

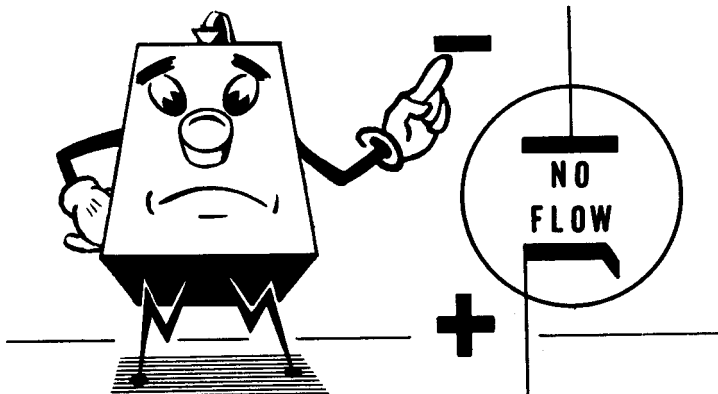

You know from your previous experiment with a diode that when the tube is connected across the 60 cycle power line the diode plate becomes positive 60 times per second and negative 60 times per second. Connecting the diode to the high voltage winding of a transformer keeps the situation exactly the same except that the voltage put on the plate is much higher, and the resulting pulsating DC is at a correspondingly higher voltage.

## HALF-WAVE RECTIFIERS—TRANSFORMER TYPE

### The Diode in a Transformer Type Circuit (continued)

Suppose you put the diode into a simple half-wave circuit with a transformer and see how it changes AC into DC.

When the transformer voltage makes the rectifier tube plate positive, electrons flow, and a voltage appears across the load.

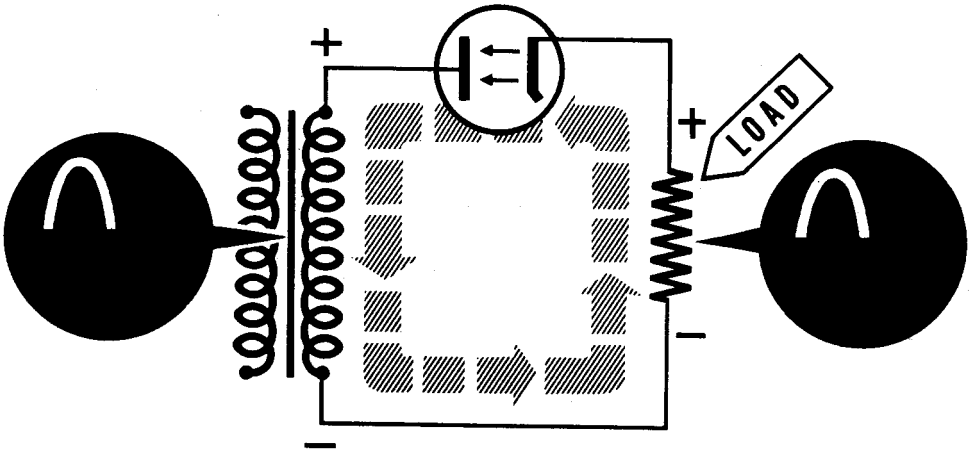

When the transformer voltage makes the rectifier tube plate negative, electrons cannot flow and, of course, no voltage can appear across the load.

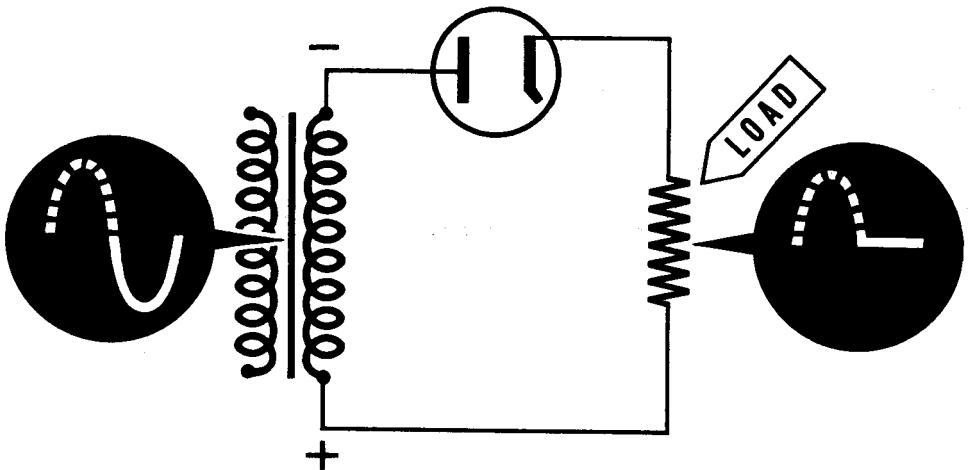

The diode rectifier tube, by allowing electrons to flow through it in only one direction (from cathode to plate), causes pulses of current to flow through the load and, therefore, causes a pulsating DC voltage to appear across the load. The AC voltage input from the transformer appears as a pulsating DC voltage across the load. Notice that the half-wave rectifier has used only the positive half of the AC input. The negative half is not used at all.

## HALF-WAVE RECTIFIERS—TRANSFORMER TYPE

### Circuit Diagram of a Transformer Type Circuit

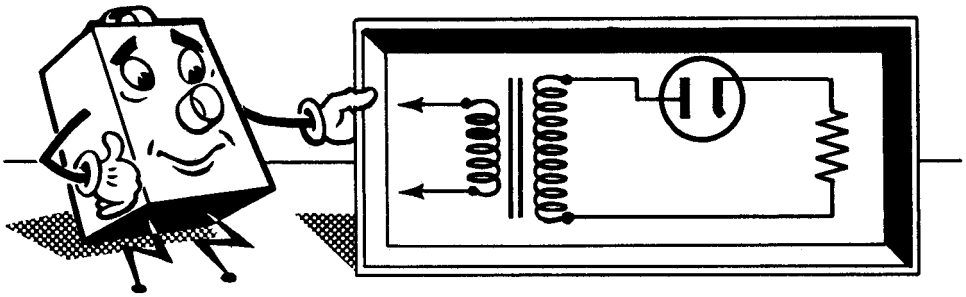

Compare the above schematic of the half-wave rectifier to the one below.

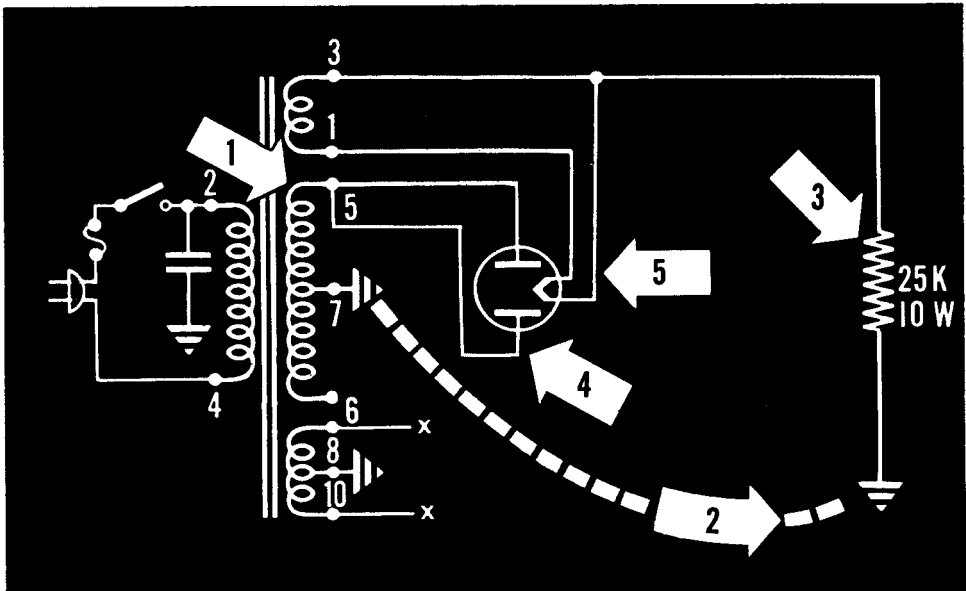

Notice the similarity between the two circuits. You can see that:

1. Only one-half of the transformer high voltage winding is used—the half from terminal 5 to terminal 7. This supplies the rectifier tube plate voltage.
2. The current path from the transformer to the load will be through the chassis (ground).
3. The load will be represented by the 25K resistor.
4. The two plates of the rectifier tube have been wired together so that the tube acts like a single diode.
5. The tube has a directly heated cathode. Therefore, the cathode is connected to the transformer filament winding—terminal 1 and terminal 3—as well as the load.



## HALF-WAVE RECTIFIERS—TRANSFORMER TYPE

### Operation of the Transformer Type Circuit

The basic operation of the half-wave rectifier circuit just shown has been described previously. In the circuit diagram illustrated the flow of current through the circuit is indicated by arrows. The + and - signs show the reversal in polarity of the transformer secondary voltage for alternate half cycles. The rectifier tube will only conduct from cathode (filament) to plate, and only when the plate is positive with respect to the cathode.

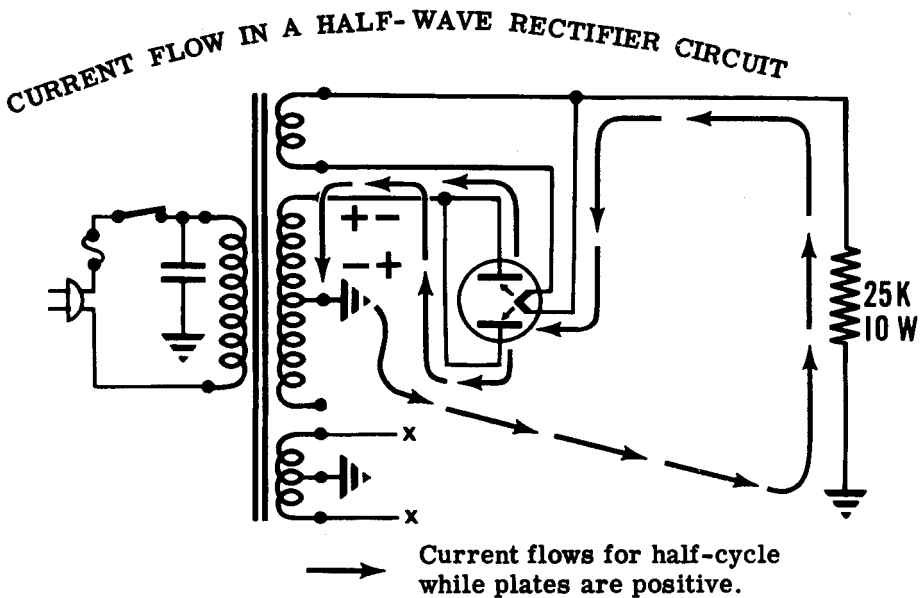

The .001 mfd. capacitor used does not effect the circuits basic operation as a half-wave rectifier. This condenser is connected between one side of the AC power line and ground to reduce electrical interference and prevent such interference from passing through the rectifier circuit. Capacitors used for this purpose may be connected in any of the ways illustrated below.

### POWER LINE FILTER CONDENSER CIRCUITS

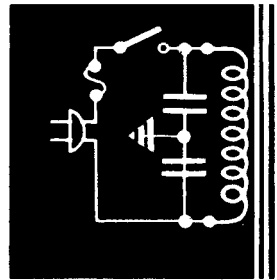
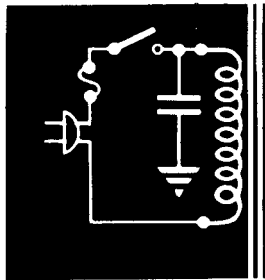
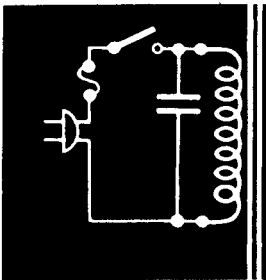

# HALF-WAVE RECTIFIERS—TRANSFORMER TYPE

## Review of the Half-Wave Rectifier Circuit

**TRANSFORMER TYPE POWER SUPPLY** — A power supply which uses a transformer to either raise or lower the AC power line voltage to obtain a desired value of DC output voltage.

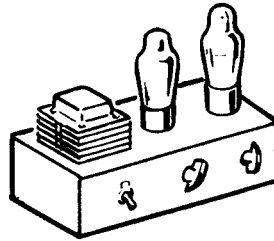

**HALF-WAVE RECTIFIER CIRCUIT** — A rectifier circuit using a single rectifier unit which changes AC to DC by allowing current to flow only in one direction. Alternate half-cycles of the AC power wave are utilized to provide a pulsating DC output. The circuit sometimes uses a transformer to increase or decrease the output voltage.

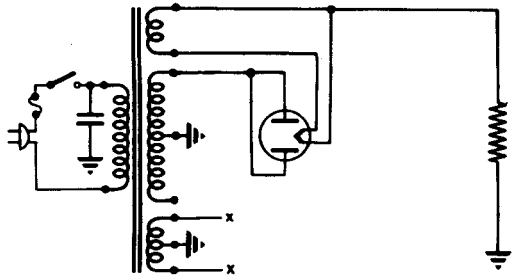

**CURRENT FLOW IN A HALF-WAVE RECTIFIER CIRCUIT** — AC is applied to the rectifier plate and current flows only during those half-cycles which are positive on the plate side of the circuit input.

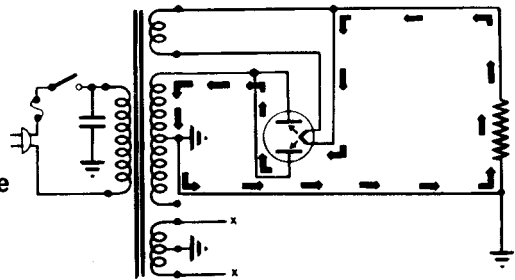

**HIGH VOLTAGE MEASUREMENT** — Always use only one hand in measuring voltages or testing circuits where high voltage is present. Use a test prod which is insulated and rated for working with high voltages.

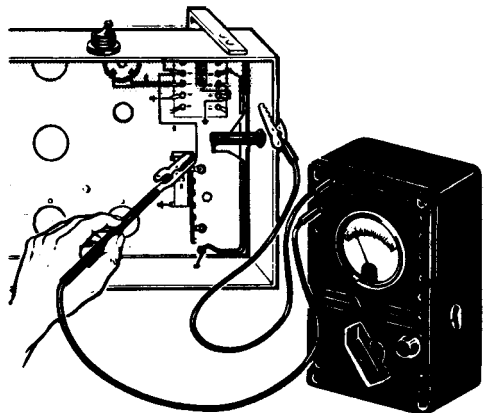

# THE FULL-WAVE RECTIFIER CIRCUIT

## Full-Wave Rectifiers

You have seen how the half-wave rectifier works. Now, in the following sheets you will see how the full-wave rectifier does the same job in a slightly different way.

You must know the full-wave rectifier because it is used in nine out of ten pieces of electronic equipment. It may be supplying any voltage from 100 volts to 5,000 volts. On any ship, any station, anywhere where electronic equipment is used, you'll find full-wave rectifiers supplying most of the power.

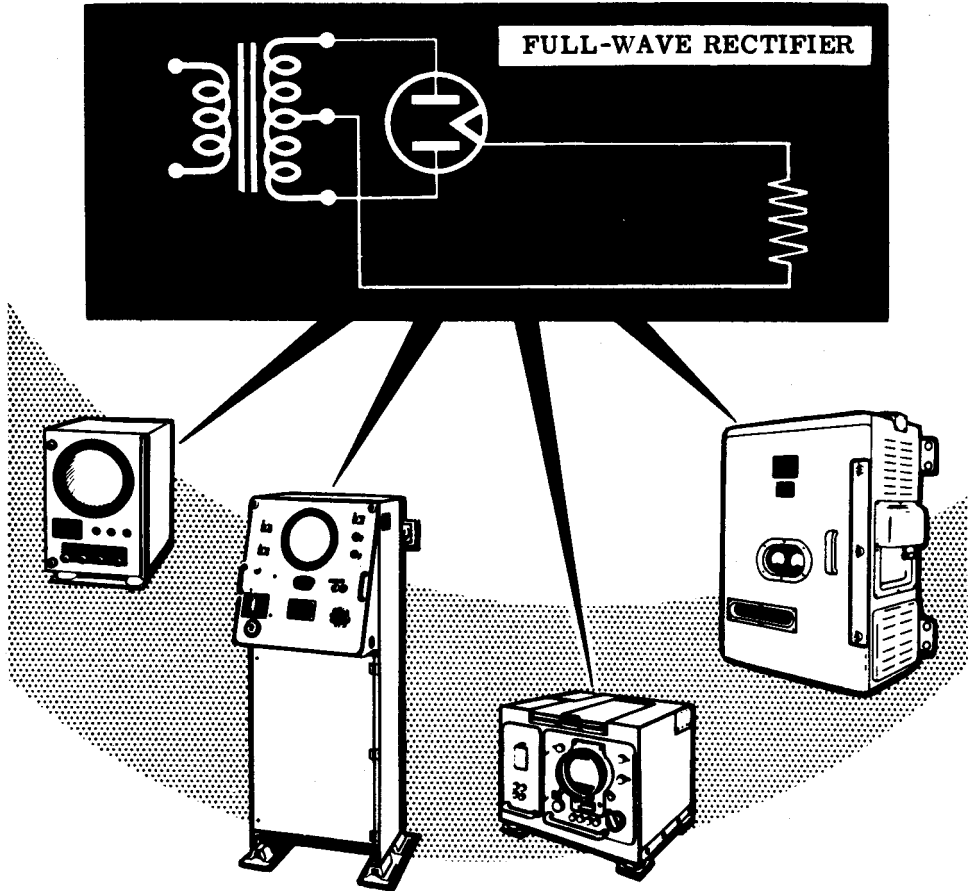

# THE FULL-WAVE RECTIFIER CIRCUIT

## How the Full-wave Rectifier Works

In a full-wave rectifier circuit a diode rectifier tube is placed in series with each half of the transformer secondary and the load. Effectively, you have two half-wave rectifiers working into the same load.

On the first half-cycle the transformer's AC voltage makes the upper diode rectifier plate positive so that it conducts and, as a result, current flows through the load causing a pulse of voltage across the load. Notice that, while the upper diode conducts, the lower diode plate is negative with respect to its cathode so that it does not conduct.

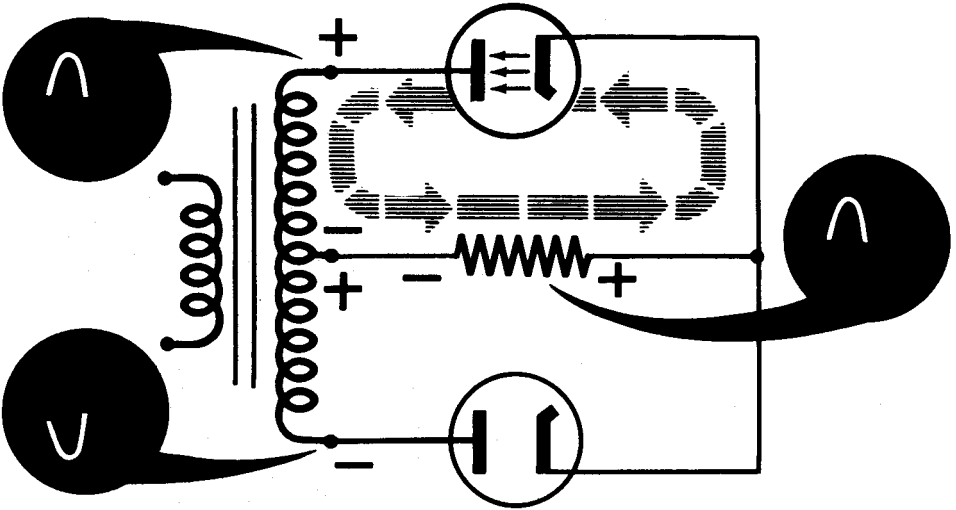

On the second half-cycle the plate of the upper diode is negative so that it cannot conduct, whereas the plate of the lower diode is positive so that current flows through it and through the load. Since both pulses of current through the load are in the same direction, a pulsating DC voltage now appears across the load. The full-wave rectifier has changed both halves of the AC input into a pulsating DC output.

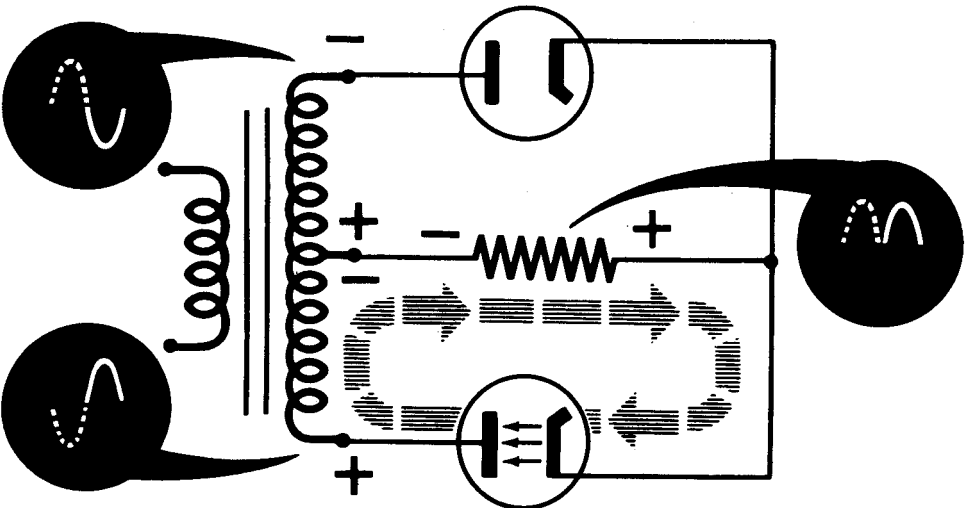

## THE FULL-WAVE RECTIFIER CIRCUIT

### The Full-wave Rectifier Tube

The diagram on the previous sheet shows two separate rectifier tubes being used in the full-wave rectifier circuit. Sometimes you may find this circuit used in power supplies but more frequently just one tube is used in the full-wave rectifier. If you will refer back to the diagram on the previous sheet, you will see that the filaments of the two tubes are connected together.

Since this is so, two separate rectifier tubes can be put together into one envelope so that the two plates share a common filament. The full-wave rectifier tube therefore contains two plates but only one filament. Such a tube is the 80 rectifier tube.

When a full-wave rectifier is used in a full-wave rectifier circuit, the circuit is most commonly drawn like this.

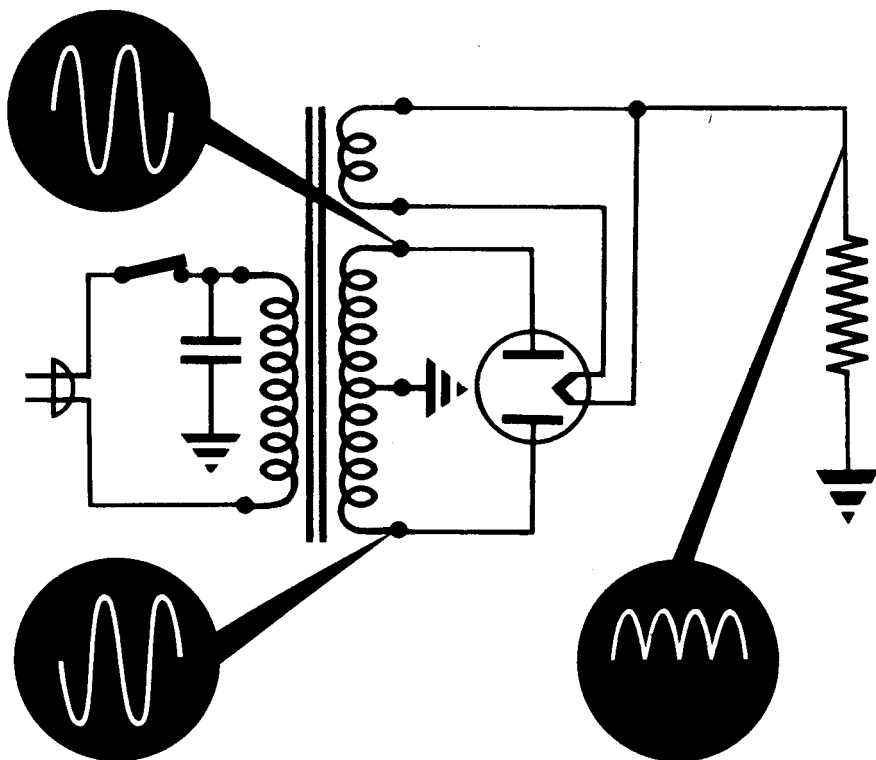

Notice that in this tube there is only one filament which supplies electrons to both plates. During one-half of the AC input cycle, one plate draws electrons from the filament and, during the other half of the cycle, the other plate draws the electrons. As in any diode, the direction of current flow inside this tube is always from the filament and this current flows first to one plate and then to the other. The load, which is in series with the filament, therefore has pulsating DC current flowing through it.

# THE FULL-WAVE RECTIFIER CIRCUIT

## Current Flow in the Full-wave Rectifier Circuits

The illustration below compares the operation of the full-wave rectifier circuit to that of a basic full-wave rectifier.

In the basic circuit illustrated, plates 1 and 2 of the rectifier tube are connected to opposite ends of the transformer winding so that there is always a 180 degree phase difference between the voltages applied to the two plates. Current flows only to that plate which is positive so that current flows from a common cathode to each plate on alternate half cycles. Since the load resistor is connected between the cathode and the transformer secondary winding centertap, the current flow in the load resistor is in the same direction for both half cycles.

In the basic full-wave rectifier circuit two cathodes are used but since they are connected together a single common cathode can be used instead in a typical circuit. Also in the basic circuit one end of the load resistor connects directly to the transformer secondary winding centertap and no ground connection is used. This connection can be made by grounding the centertap and one end of the load resistor to different points on the chassis.

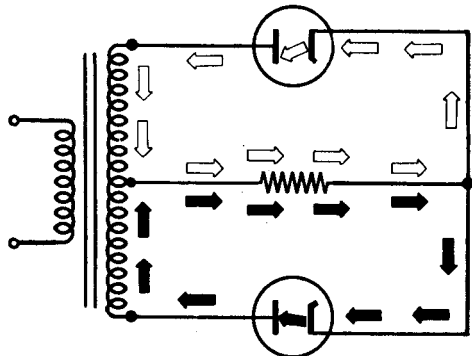

**BASIC FULL-WAVE RECTIFIER CIRCUIT**

**TYPICAL COMPLETE FULL-WAVE RECTIFIER CIRCUIT**

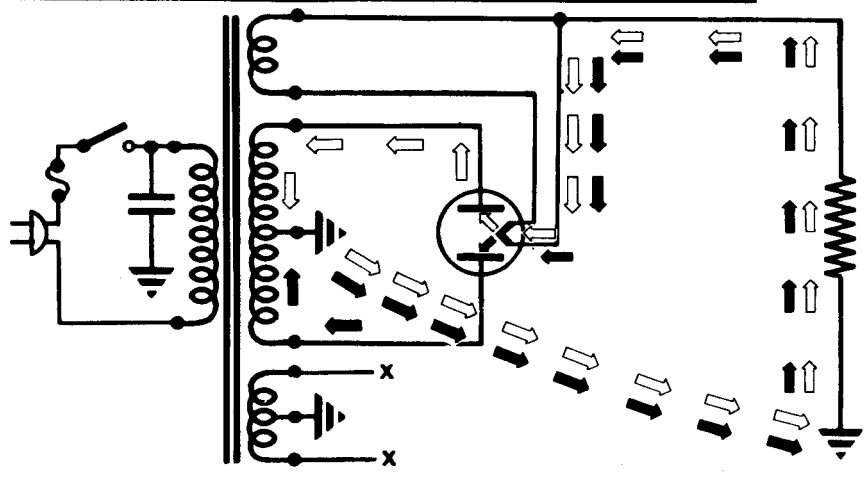

# THE FULL-WAVE RECTIFIER CIRCUIT

## The Bridge Rectifier Circuit

The bridge rectifier, just like the other rectifiers you have studied, changes AC voltage to DC voltage. Here's how it does it!

Four dry metal rectifiers are hooked together with the AC input and the load as shown. As the AC voltage input swings positive, current flows from one side of the input through one dry metal rectifier, through the load, and then through another dry metal rectifier back to the other side of the input.

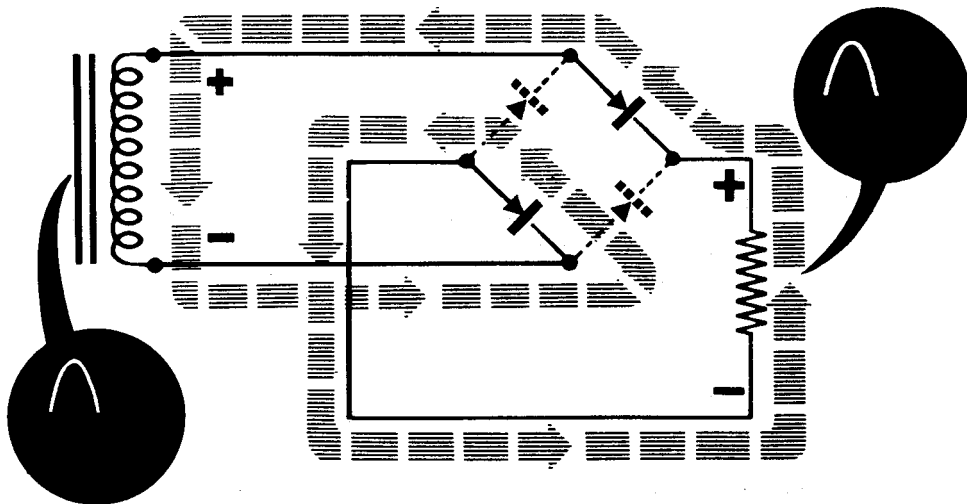

Then, when the AC voltage input swings negative, current flows through the other pair of dry metal rectifiers and the load. Notice that the current flow through the load is in the same direction during both half-cycles of the input wave. Therefore, the voltage developed across the load is pulsating DC which can, of course, be filtered just as any other pulsating DC output from a rectifier circuit.

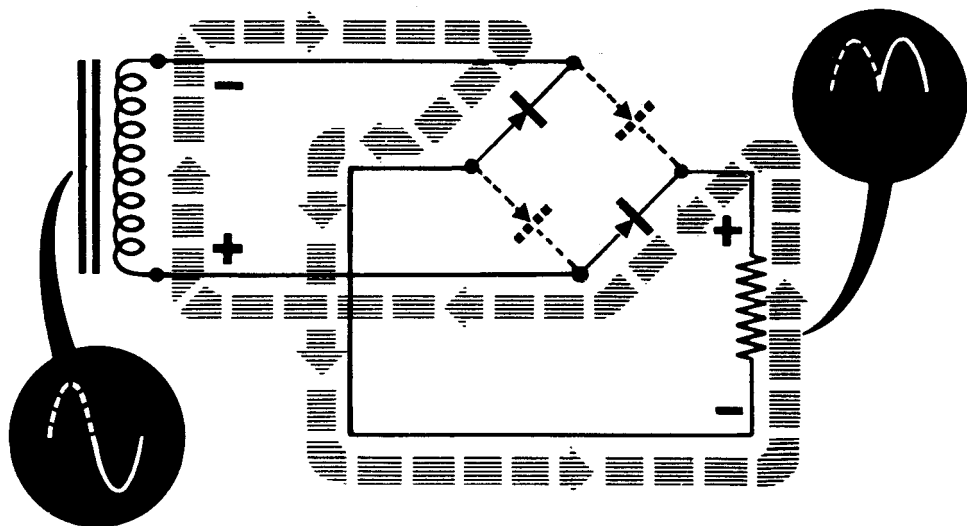

# THE FULL-WAVE RECTIFIER CIRCUIT

## The Bridge Rectifier Circuit (continued)

In actual practice the four dry metal rectifier units used in the bridge rectifier circuit are joined together in one physical unit and are connected externally into the bridge rectifier circuit.

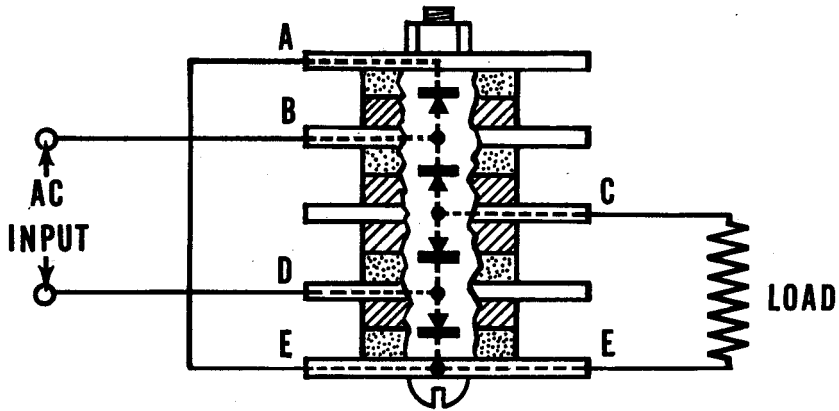

To get from the pictorial to the schematic diagram, just imagine the two end units being rotated around as shown below. Before you continue, make sure you understand the relationship between the physical unit and the schematic.

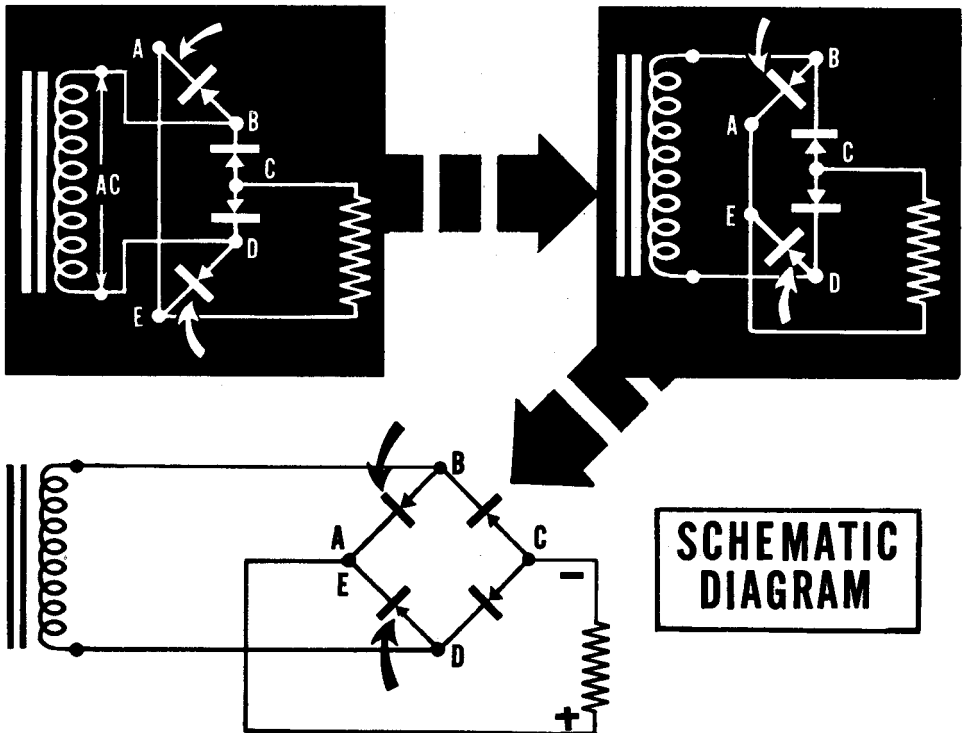



# THE FULL-WAVE RECTIFIER CIRCUIT

## Review of the Full-Wave Rectifier Circuit

### FULL-WAVE RECTIFIER CIRCUIT -

A rectifier circuit which utilizes both cycles of the applied AC voltage to obtain pulsating DC. A center-tapped transformer secondary winding is used with two diodes rectifying alternate half cycles of the voltage, causing pulses of current to flow in the same direction through a load resistor for each half cycle of applied AC.

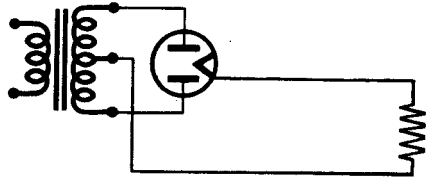

### FULL-WAVE RECTIFIER TUBE - A

vacuum tube consisting of two specially designed diodes and a common cathode in the same glass envelope. Both direct and indirectly heated cathodes are used depending on the requirements of the rectifier circuit.

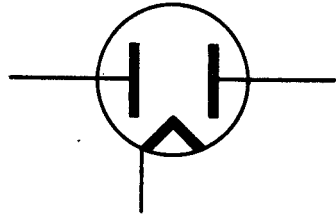

### CURRENT FLOW IN THE FULL-WAVE RECTIFIER CIRCUIT -

Current flows from the rectifier tube cathode to whichever plate is positive, then through one half of the secondary winding to the chassis ground. From the ground point it flows through the chassis to one end of the load resistor then through the load resistor back to the rectifier tube cathode.

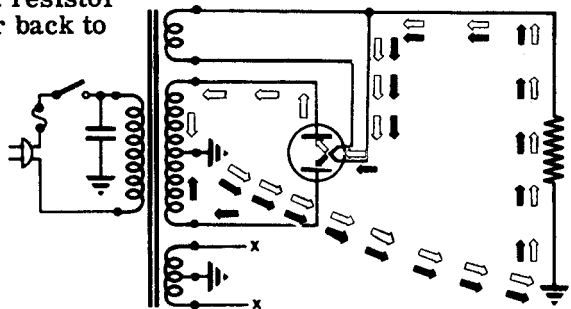

## FILTER CIRCUITS

### What You Have to Know about Power Supplies

Learning all about the various power supplies is going to be a simple job. Why? Because you can open up any power supply and find that it contains only two major circuits—the rectifier circuit and the filter circuit.

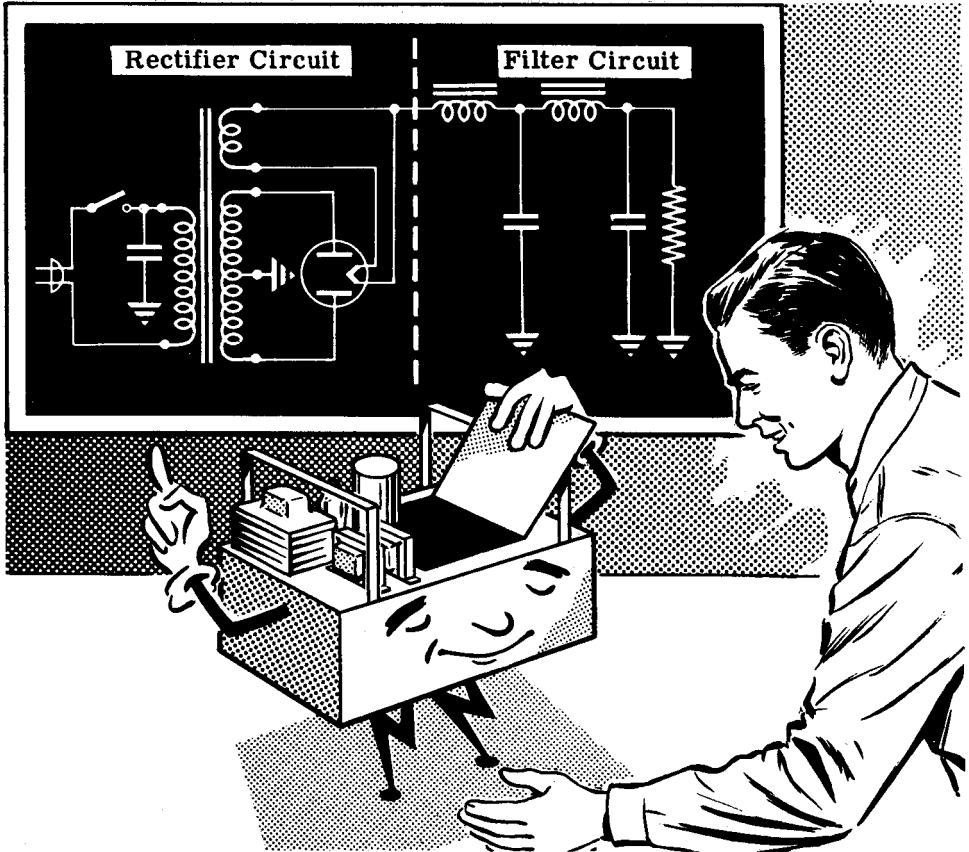

You already know that there are only two types of rectifier circuits in general use—the full-wave and the half-wave rectifiers—and they both perform the same job of changing AC into pulsating DC. There are only three types of filter circuits that are in general use. These filter circuits all have one thing in common—they remove the ripple from the pulsating DC output of the rectifier.

In addition, there is only one basic type of voltage regulator tube which is used with power supplies. As its name implies, this tube maintains the output voltage of a power supply at a required value in spite of line voltage fluctuations or variations of load current.

Know these power supply circuits and you know almost all you will ever have to know about power supplies. This is true because nearly every power supply that exists consists of various combinations of basic rectifier circuits, basic filter circuits, and voltage regulator tubes.

The three most common types of filter circuits used are shown on the next sheet.

# FILTER CIRCUITS

## Power Supply Filter Circuits

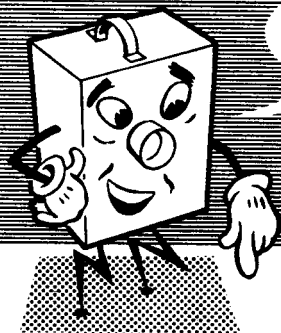

Here are THE THREE FILTER CIRCUITS YOU WILL LEARN NOW

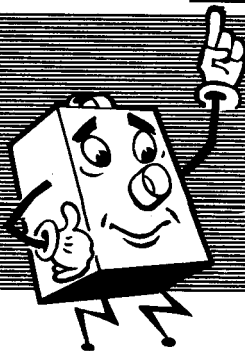
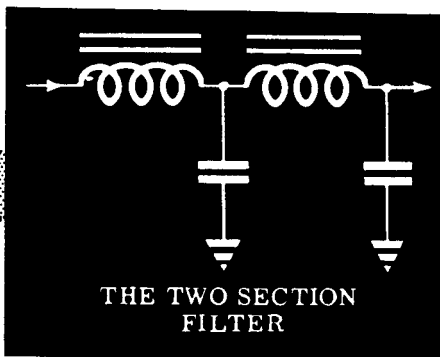
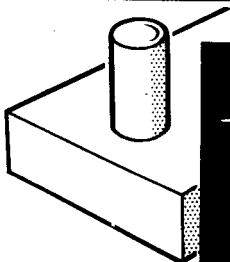
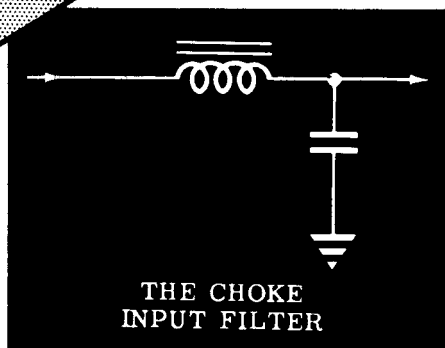
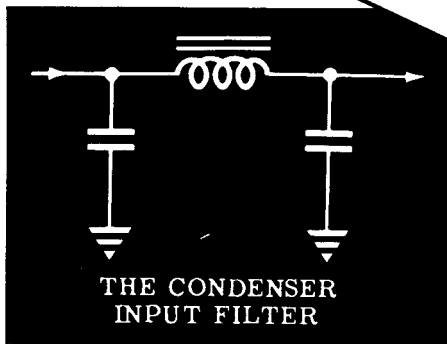
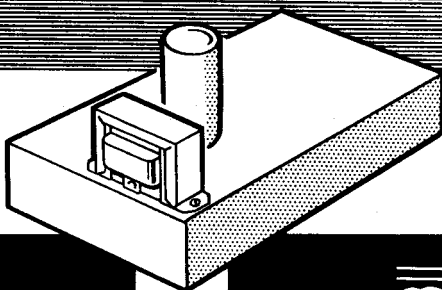

THESE ARE THE FILTERS YOU WILL SEE IN YOUR POWER SUPPLY CIRCUITS

# FILTER CIRCUITS

## Characteristics of the Rectifier Output

You have been told that electronic circuits in general require a source of about +350 volts DC and a source of 6.3 volts AC in order to operate. The power supply transformer supplies the 6.3 volts AC directly to the heaters of the tubes requiring it. The transformer feeds high voltage AC into the rectifier and rectifier puts out pulsating DC that looks like this:

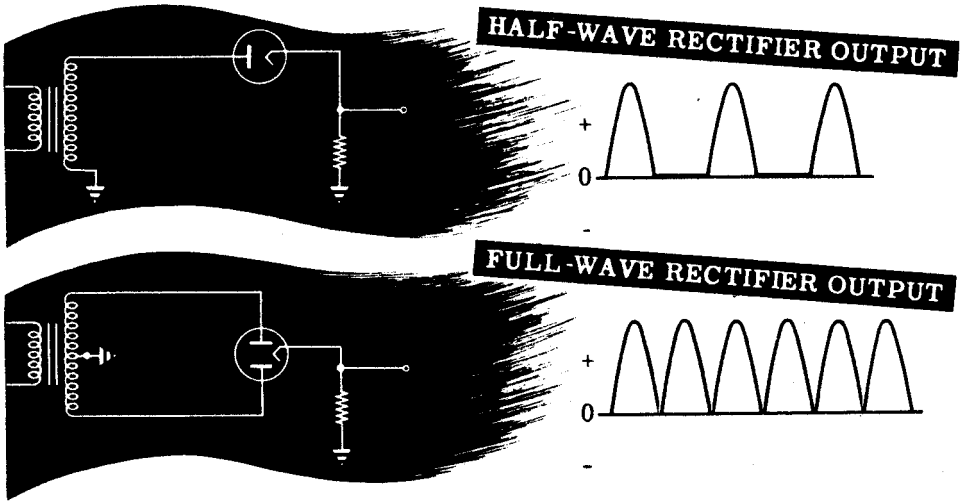

The electronic circuits which are connected to the power supply output cannot use a pulsating voltage of this sort. What these circuits require is a steady DC voltage with as little pulsation as possible. The purpose of the filter circuit is to remove the pulsations from the rectifier output and deliver a steady DC voltage.

The output of a rectifier tube consists of pulses of current which always flow in the same direction through the load resistor. The current rises from zero to a maximum and then falls to zero, repeating this cycle over and over again. At no time does the electron current through the load resistor change its direction and flow from the filament to ground. The voltage resulting from this flow of electrons through the load resistor is a voltage that rises from zero to a maximum and then falls back to zero, repeating this cycle over and over again. This voltage takes on the shape of half sine waves. In the case of a half-wave rectifier the average DC voltage is 31.8 percent of the peak value. In the case of a full-wave rectifier the average DC is 63.6 percent of the peak value.

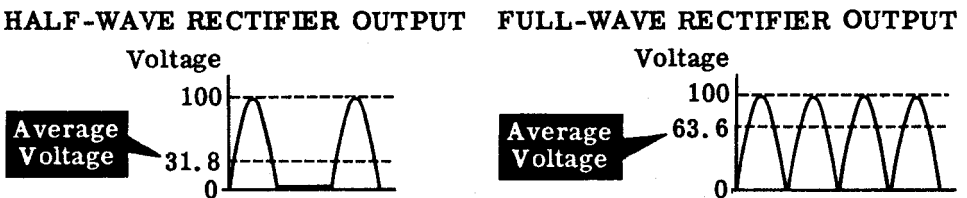

## FILTER CIRCUITS

### AC and DC Components

If you connect a DC voltmeter across the rectifier output you will get a reading. If you connect an AC voltmeter across the rectifier output, you will also get a reading. This AC reading is a result of the output voltage variation. Therefore, the output of the rectifier can be considered as a DC voltage with an AC voltage superimposed upon it. You can look upon the job of a filter circuit as the job of removing the AC portion (or AC component) of the rectifier output and allowing only the DC component to get to the power supply output terminals. If the filter succeeds in removing all of the AC from the rectifier output, only pure DC will be left.

You may now ask the question "How can a pulsating DC voltage have an AC component if the voltage rises from zero to a high positive value and falls back to zero, but never becomes negative?" You have always thought of an AC voltage as one which alternates above and below a zero voltage, first becoming positive, then zero and then negative. If the voltage never becomes negative, how can there be any AC in it?

Any wave that varies in a regular manner has an AC component. Suppose you examine an example in which an AC voltage is combined with a DC voltage and the result is a voltage wave which never becomes negative. Suppose you have a voltage of +50 volts DC and you combine it with an AC voltage which varies from +20 volts through zero to -20 volts.

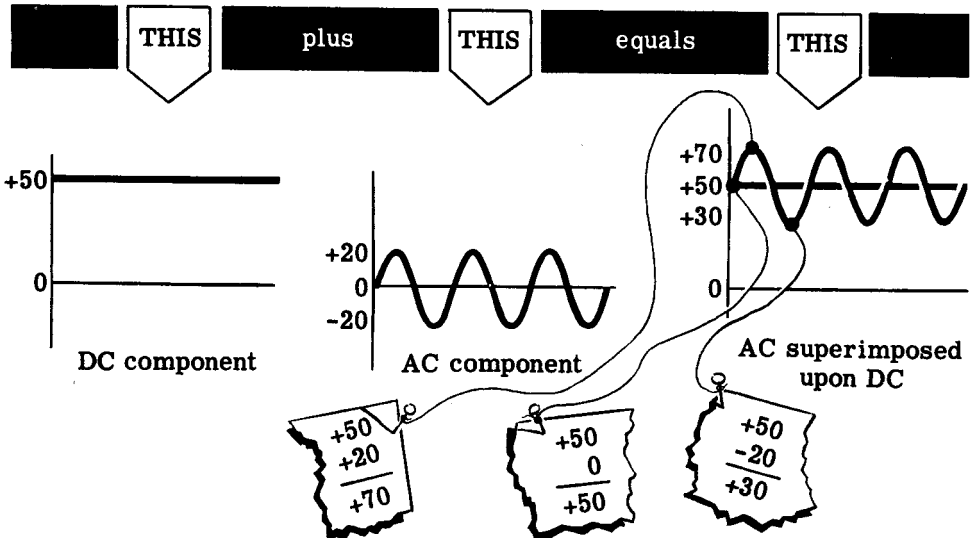

When the +20 volt AC peak is added to the +50 volts DC, the result is +70 volts. When the 0 volt point on the AC wave is added to the +50 volts DC, the result is +50 volts. When the -20 volts AC peak is added to the +50 volts, the result is +30 volts. The total result is a DC voltage which varies from +50 volts—up to +70 volts and down to +30 volts. The voltage of the resulting wave never becomes negative and yet it consists of an AC component and a DC component.

# FILTER CIRCUITS

## AC and DC Components (continued)

You have seen how a DC voltage and an AC voltage can be added together to give a voltage wave which never becomes negative. Here are a few more examples:

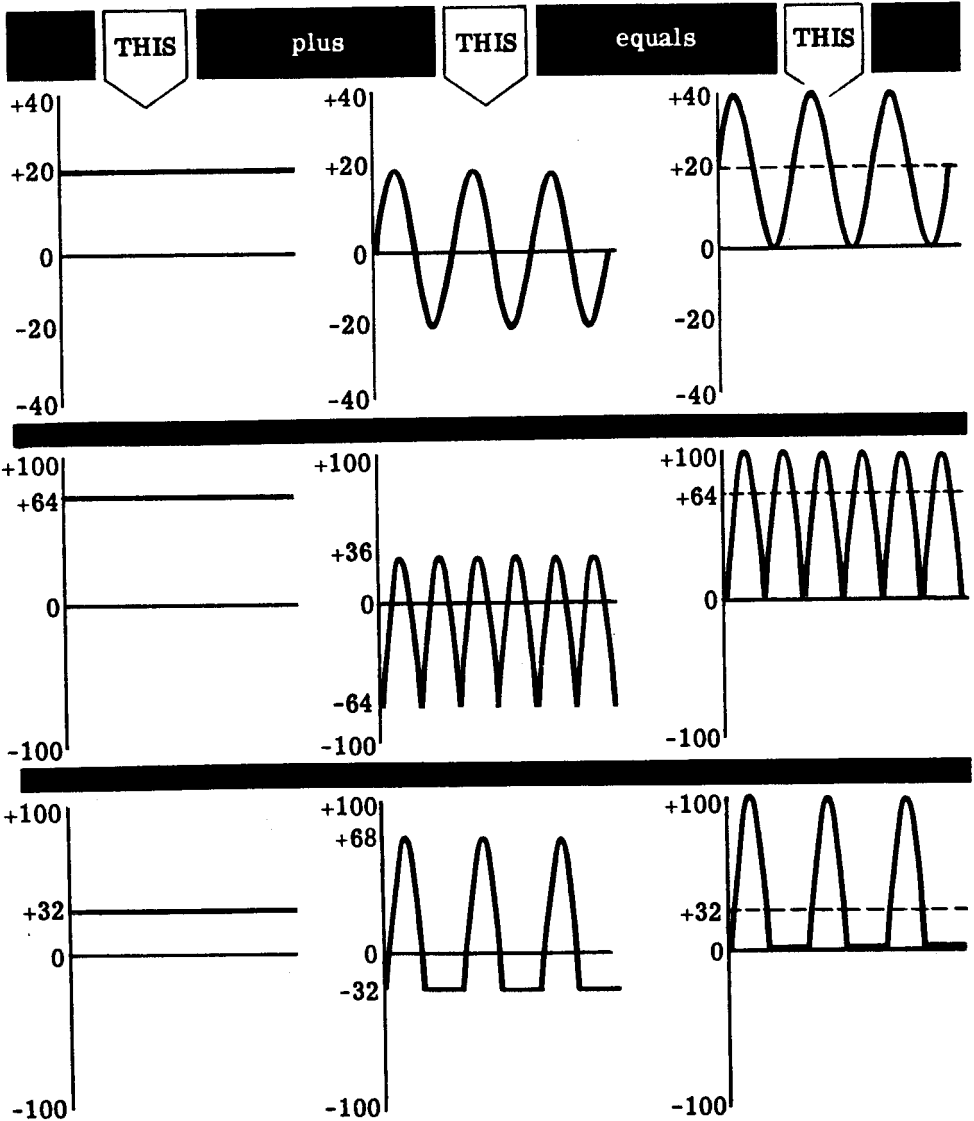

You can see that as long as a voltage varies in any regular manner, it can be broken up into a DC component and an AC component. The output of a rectifier contains both a DC component and an AC component. It is the job of the filter to remove as much of the AC voltage as is possible (and economical!) before the resulting high voltage DC is fed to the electronic circuits which require it.

## FILTER CIRCUITS

### The Condenser in the Filter Circuit

If you remove the load resistor from the output of the rectifier and replace the resistor with a large condenser, pure DC will appear across the condenser. When you find out why this takes place, you will see how this effect can be used in filter circuits.

You know that, when a condenser is placed across a battery, it charges up to the battery voltage if it is given enough time.

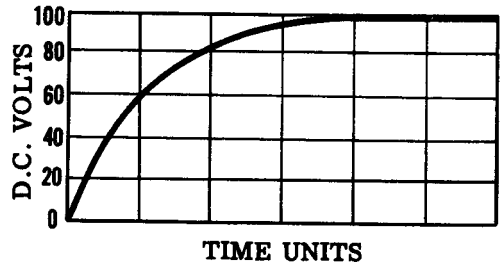
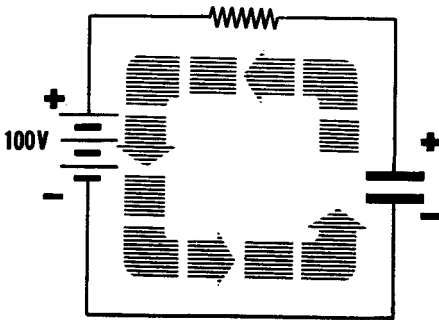

The same is true when a condenser is placed across the output of a rectifier. The rectifier starts charging up the condenser every time it conducts. If the condenser does not have time to charge up to the peak of the pulsating DC wave on the first half-cycle, it will do so during the next few half-cycles. After a few cycles have passed, there will be pure DC across the condenser. Because current can flow in only one direction through the rectifier, the condenser will not discharge between the peaks of the pulsating DC voltage. What has been the effect of placing the condenser across the output of the rectifier? By charging up, the condenser has filtered out the ripple in the pulsating DC, leaving pure DC.

### *Action of the Filter Condenser...*

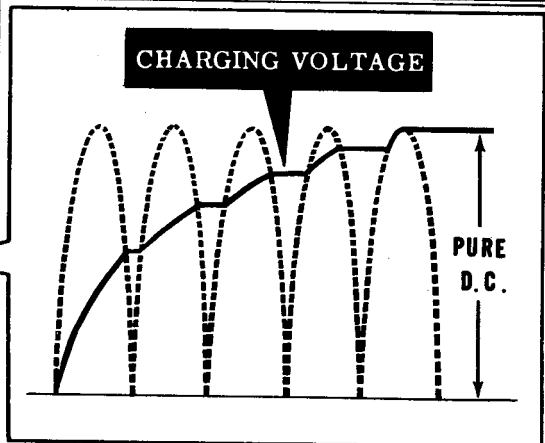
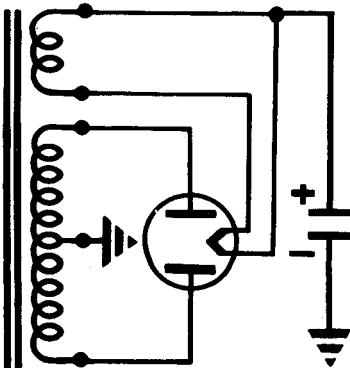

## FILTER CIRCUITS

### The Condenser in the Filter Circuit (continued)

If a power supply did not have to supply current to other circuits, pure DC voltage could be obtained simply by connecting a condenser from the rectifier filament to ground. However, the various electronic circuits do draw a certain amount of current. The current drawn by these electronic circuits is called the load current, and the effect of this load current can be duplicated by connecting a load resistor across the rectifier output and ground.

You know from your study of RC circuits in Basic Electricity that when a resistor is placed across a charged condenser, the condenser will discharge through the resistor. The speed of the discharge will depend upon the size of the resistor. The lower the resistance the more current will be drawn from the condenser, and the faster will be the discharge.

As soon as the resistor is connected across the condenser of the rectifier circuit, that condenser will begin to discharge and the voltage will drop. The voltage, however, will not drop to zero because a new voltage peak appears at the rectifier filament 60 times a second for a half-wave rectifier and 120 times a second for a full-wave rectifier. This voltage peak will recharge the condenser, and then the condenser will proceed to discharge through the resistor until the next voltage peak comes along. The result will be a pulsating DC output. Notice that the pulsations are much smaller than you would get with no condenser.

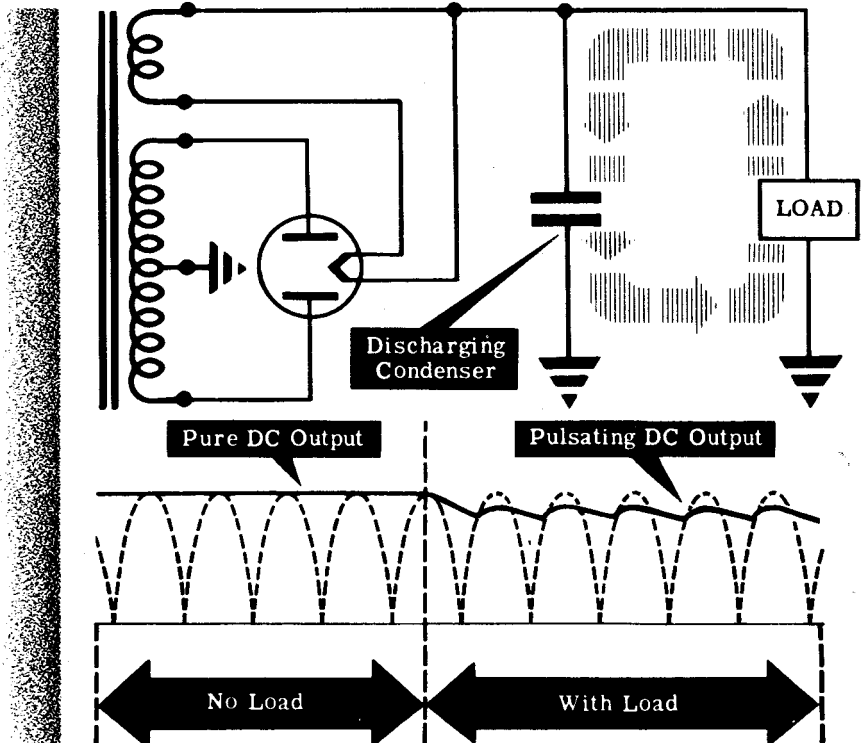



## FILTER CIRCUITS

### The Condenser in the Filter Circuit (continued)

The result of placing a load on the single filter condenser is that the output of the rectifier is no longer pure DC—it is DC upon which is superimposed an AC component. This AC component is called "ripple." It is because of this AC component or ripple that a condenser, by itself, does not constitute a satisfactory filter. Additional filtering components have to be added to remove the ripple and make the final B+ output as close to pure DC as is possible and economical. Just why ripple in the B+ output is so undesirable is something you will learn when you come to the study of amplifiers.

The amount of ripple resulting from a load placed across a single filter condenser depends upon the size of the load, the size of the condenser and the type of rectifier. The larger the condenser the more electrons it can accumulate on its plates, and it will discharge a smaller amount when a load is put across it. The larger the load current drawn out of the condenser the larger will be the voltage drop, and the larger will be the ripple. Since half-wave rectifiers will charge the condenser 60 times per second, there will be more time for the condenser to discharge through the load than with a full-wave rectifier which charges the condenser 120 times per second. Thus the ripple will be greater for a half-wave rectifier than for a full-wave rectifier because the voltage will drop a greater amount during pulses.

The larger the load the greater the ripple

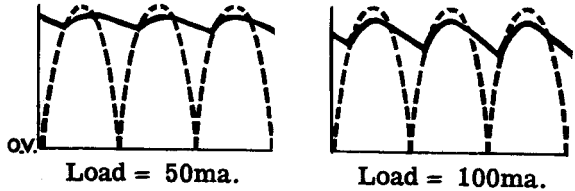

The smaller the capacity of the condenser the greater the ripple

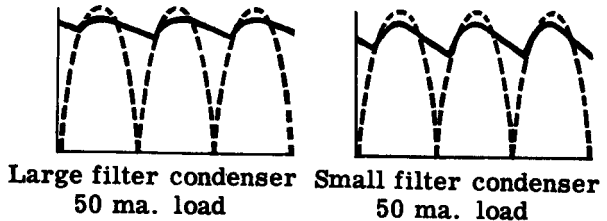

Same load, same filter condenser

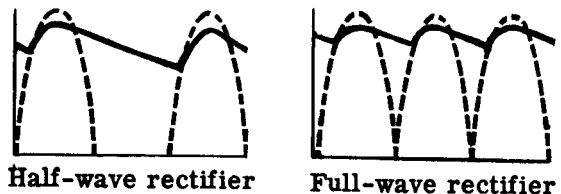

## FILTER CIRCUITS

### Filter Condensers

Filter condensers (capacitors) used in power supplies are of two types: (1) paper dielectric condensers and (2) electrolytic condensers.

Paper condensers are constructed of alternate layers of metal foil and waxed paper rolled together. The waxed paper is the dielectric with the metal foil being used as plates. Paper condensers smaller than 1 mfd. are used throughout most electronic equipment and larger values are sometimes used as filter condensers in power supplies.

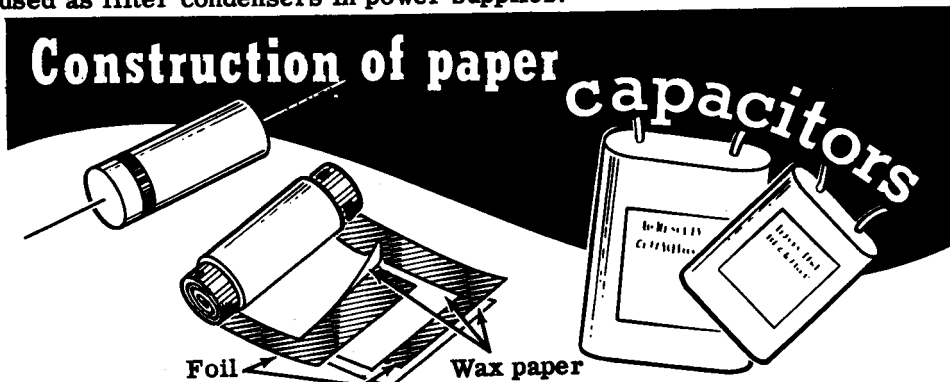

Paper condensers are not polarized and when operated within their voltage rating they last much longer than electrolytic condensers. However, large sizes of paper condensers are bulky and relatively expensive. They are normally not made larger than 16 mfd.

High voltage power supplies use paper filter condensers which are oil impregnated and will withstand greater peak voltages than those impregnated with wax. Condensers are rated according to direct current working voltage (DCWV) and also in peak voltage. The DCWV is the maximum voltage the condenser is designed to operate at continuously. The peak voltage is the voltage above which the condenser dielectric will break down and act as a conductor.

### HIGH VOLTAGE PAPER FILTER CAPACITORS

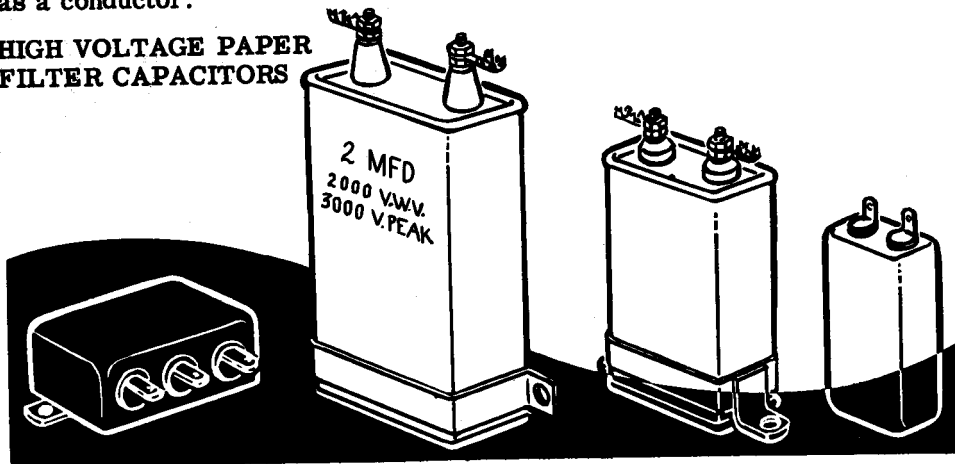

## FILTER CIRCUITS

### Filter Condensers (continued)

Electrolytic condensers are usually used as power supply filter condensers because they can be made in very large sizes at low cost and are much smaller physically than paper condensers of the same capacity. Electrolytic condensers are made in larger sizes than paper condensers with the usual values being between 2 mfd and 1000 mfd.

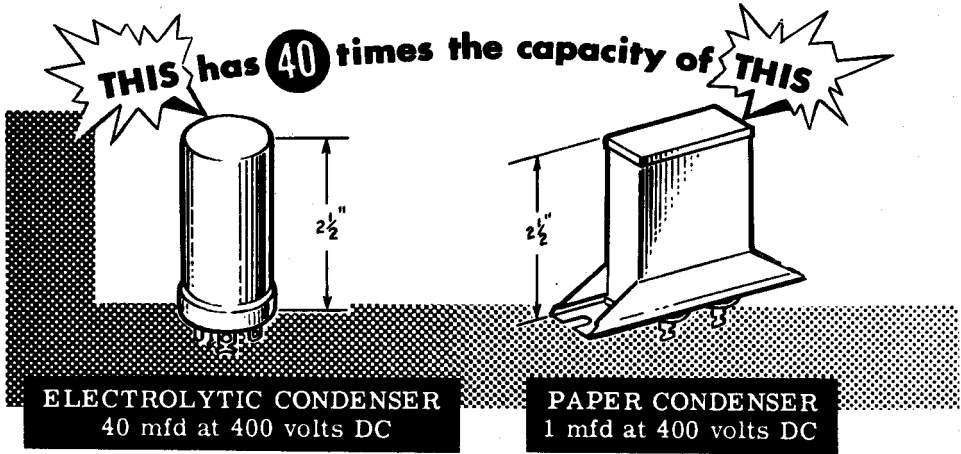

Power supplies rated at 600 volts or less usually use electrolytic filter condensers but when a higher voltage rating is required paper condensers are used. Electrolytics are polarized and failure to observe the correct polarity will not only permanently damage the condenser but may also cause it to break open and damage other parts.

While paper condensers have no leakage current (flow of direct current across the condenser dielectric) electrolytic condenser dielectrics are not perfect insulators and a leakage current flows even during normal operation. The leakage current is greater in the wet electrolytic than in the dry types. If the voltage rating of an electrolytic condenser is exceeded the leakage current increases and may damage the dielectric.

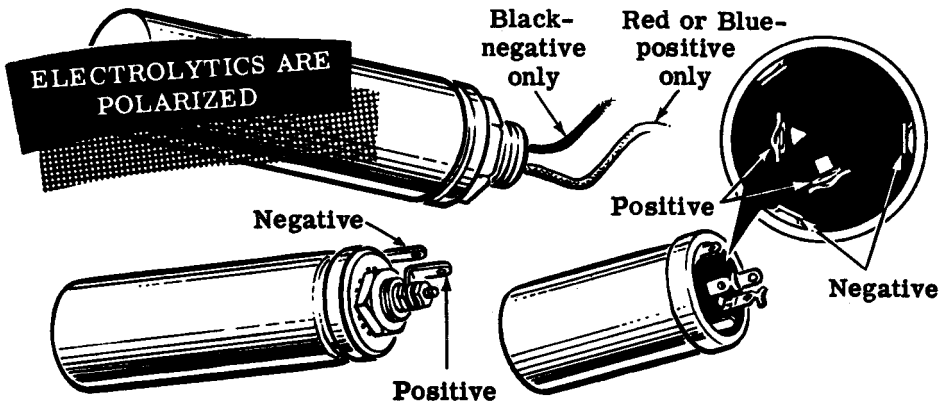

## FILTER CIRCUITS

### Filter Condensers (continued)

Electrolytic condensers are of two types: (1) wet and (2) dry.

A wet electrolytic condenser consists of an aluminum electrode immersed in a solution called an electrolyte. When the electrode is connected to the positive terminal of a DC voltage source and the electrolyte container is connected to the negative terminal, current flows through the electrolyte. This current flow results in chemical action which causes a film to form on the electrode surface. This film acts as a dielectric, insulating the electrode from the electrolyte. These two elements then act as plates in a condenser—the electrode becoming a + terminal, and the electrolyte a - terminal. The connection to the electrolyte is made through the container.

Reversing the polarity of the voltage applied to the condenser breaks down the dielectric completely. A momentary overload in the correct polarity punctures the dielectric but application of the rated voltage reforms the dielectric so that wet electrolytics are said to be self-healing.

The capacitance of an electrolytic condenser is greater than that of a paper condenser of equivalent physical size because the dielectric film is very thin, enabling close spacing between the condenser plates. The positive plate surface is roughened and the liquid electrolyte negative plate follows the rough surface of the positive plate resulting in greater plate area in a given space.

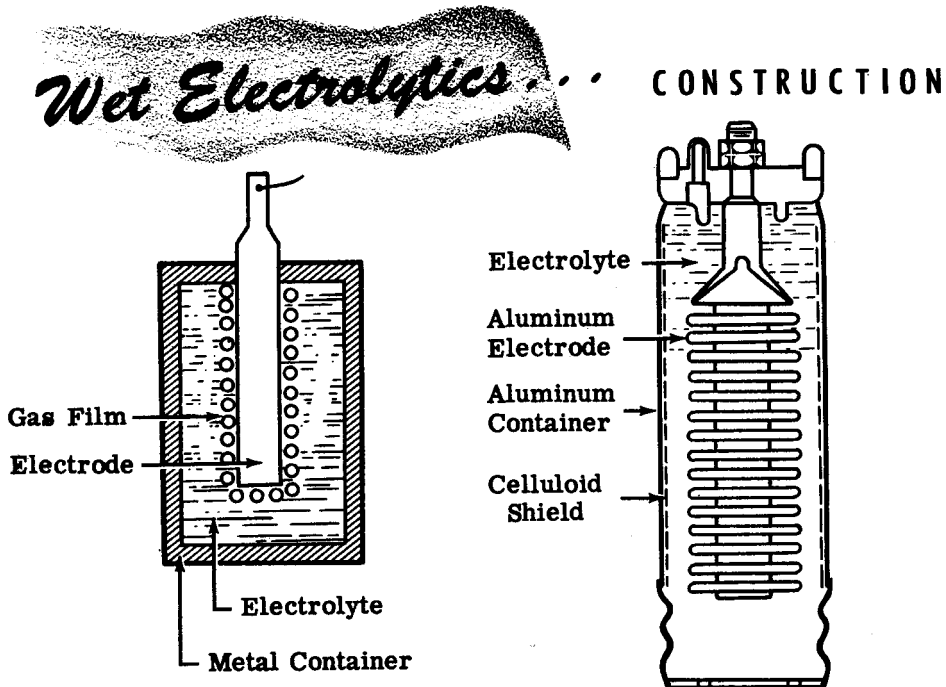

## FILTER CIRCUITS

### Filter Condensers (continued)

Dry electrolytic condensers use an electrolyte in the form of paste. A cloth impregnated with the electrolytic paste is rolled between alternate layers of aluminum foil in the same manner as that used to make paper condensers. One layer of metal foil is used as a positive plate of the electrolytic condenser and the other layer of metal foil is used to contact the negative plate (electrolyte) of the condenser.

A dry electrolytic condenser operates in the same way as a wet electrolytic except that it is not self-healing when the dielectric has been punctured. Both types of electrolytic condensers have a relatively short life due to the drying up of the electrolyte. Of the two, dry electrolytics generally last longer. Wet electrolytics are not often used since they dry out rapidly and must be mounted upright to prevent leaking of the liquid electrolyte. Several types of dry electrolytic condensers are illustrated below.

# DRY

## *Electrolytic Capacitor*

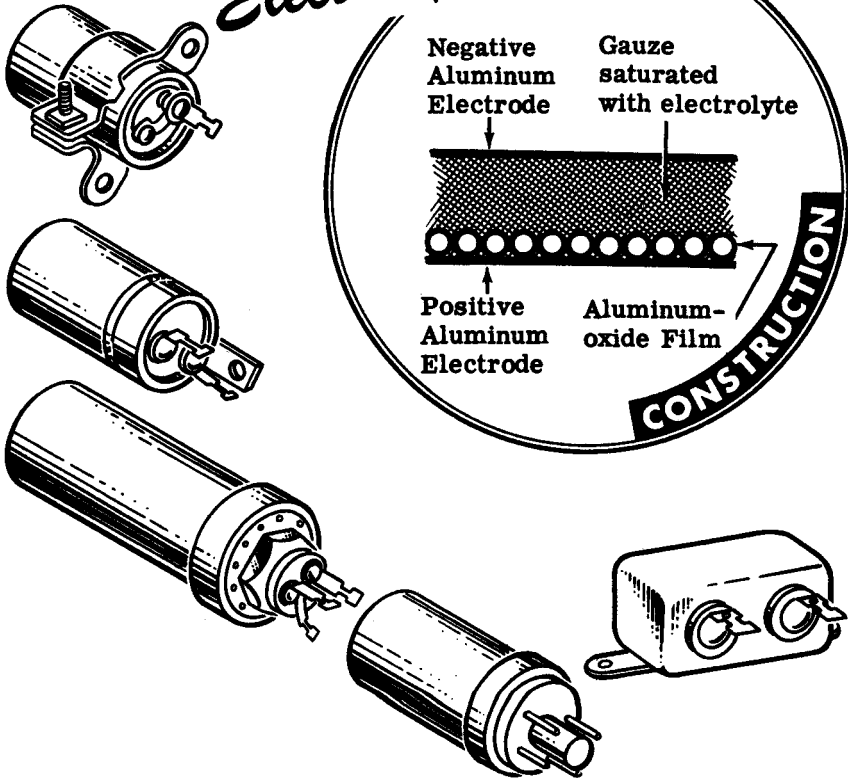

## FILTER CIRCUITS

### Improving the Operation of the Filter

You saw on a preceding sheet that the larger you make the filter condenser, the lower will be the AC component or ripple in the output. Filter condensers can be made very large in capacity and small in size, as you will see shortly, but there are size limitations that cannot be exceeded. A filter condenser of practical size might reduce the AC component to about 25 volts AC, but this is not good enough. Many electronic circuits require a B+ voltage that cannot have more than 3 or 4 volts of AC present in a DC output of 350 volts—the AC component must be less than 2 percent or even less than 1 percent of the total output voltage. No filter condenser of practical size can do this job alone—other filtering components must be added.

Suppose you set up a circuit consisting of a 500 ohm resistor connected in series with a 16 mfd condenser as shown in the illustration. If you connect this circuit to the rectifier and the single filter condenser previously used, you will be putting into this new filter circuit 350 volts DC upon which is superimposed about 25 volts of AC. To understand how this circuit removes the AC ripple voltage you will have to find out something about voltage dividers.

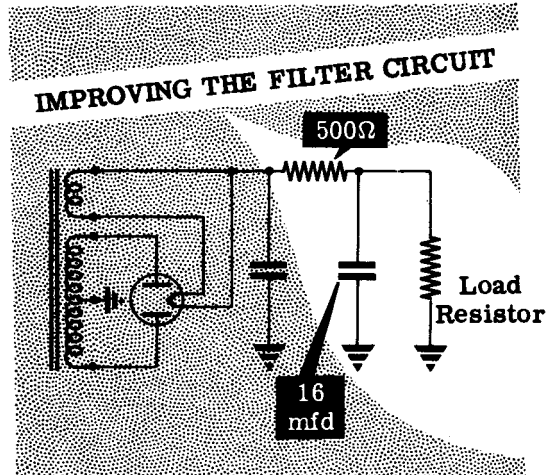

You know from your work with DC series circuits in Basic Electricity that when you place a DC voltage across three equal resistors, one third of the total voltage appears across each of the resistors. From this it can be seen that if you have two resistors and one is twice the resistance of the other, 1/3 of the voltage will appear across the small resistor, and 2/3 of the voltage will appear across the larger resistor. Similarly if one resistor contains 1/10 of the total resistance and the other resistor contains 9/10 of the total resistance; 1/10 of the total voltage appears across the small resistor and 9/10 of the total voltage appears across the large resistor. From this you can see that a DC voltage divides itself across two resistors in direct proportion to the size of the resistors.

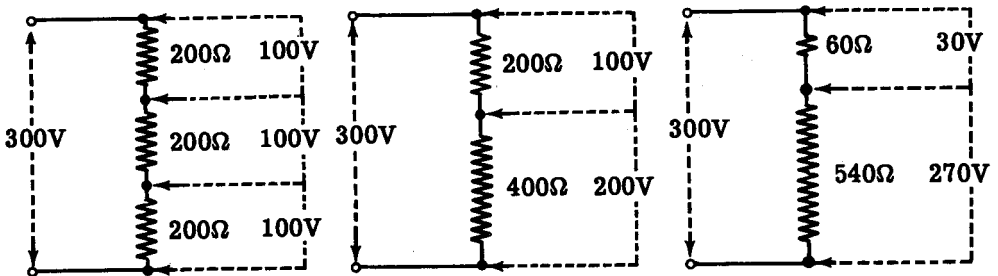

## FILTER CIRCUITS

### Improving the Operation of the Filter (continued)

When the 25 volts ripple from the input filter condenser appears across the resistor and output capacitor, as shown below, the resistor presents 500 ohms resistance and the condenser presents only 80 ohms reactance to 120 cycle AC ripple. This means that the AC ripple voltage is divided across a total of 580 ohms. About 1/7 of the AC voltage will appear across the condenser and 6/7 of the AC voltage will appear across the resistor. The AC voltage across the condenser and therefore between B+ and ground will be 1/7 of 25 volts, or about 3.5 volts AC.

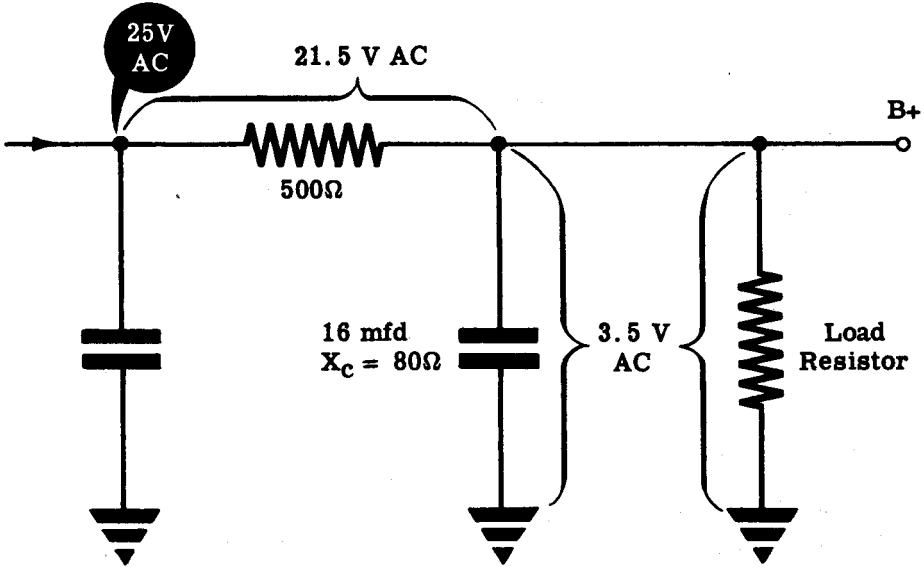

You see that the simple addition of a 500 ohm resistor and another filter condenser has succeeded in reducing the ripple voltage down to 3.5 volts which is about 1 percent of the total DC output. This amount of filtering is satisfactory for most applications in electronics.

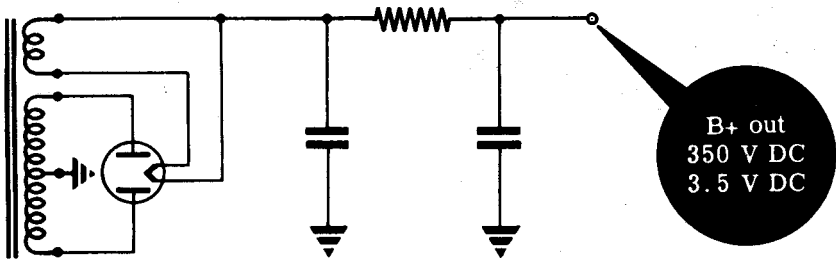

# FILTER CIRCUITS

## The Faults of RC Filters

The filter circuit you now have consists of two condensers and one resistor making up an RC filter network. This filter is compact in size, low in cost and is used in many small commercial radios.

There are two reasons why this RC filter cannot be used in most other power supplies—it is difficult to get a high B+ voltage when a large load current is required; and there is a large change in B+ voltage whenever the load current changes.

Suppose you consider the first fault—the difficulty of getting a high B+ voltage when a large load current is required. Many electronic equipments require that the power supply deliver 100 to 200 milliamps of current at a B+ voltage of 350 volts. All of this current must flow through the 500 ohm filter resistor and will, according to Ohm's law, cause a drop in voltage across that resistor. This means that if 200 milliamps flow through 500 ohms, the voltage drop across the resistor will be—

$$E = IR = 0.200 \text{ amp} \times 500 \text{ ohms} = 100 \text{ volts}$$

Instead of getting 350 volts out of the filter, you will get only 250 volts (350 - 100 = 250V). In order to get 350 volts out of the filter, the transformer will have to be made so that it will feed a much higher voltage into the rectifier to make up for the loss of voltage across the resistor. Increasing the voltage output of the transformer makes it larger, heavier and more expensive—three very undesirable qualities.

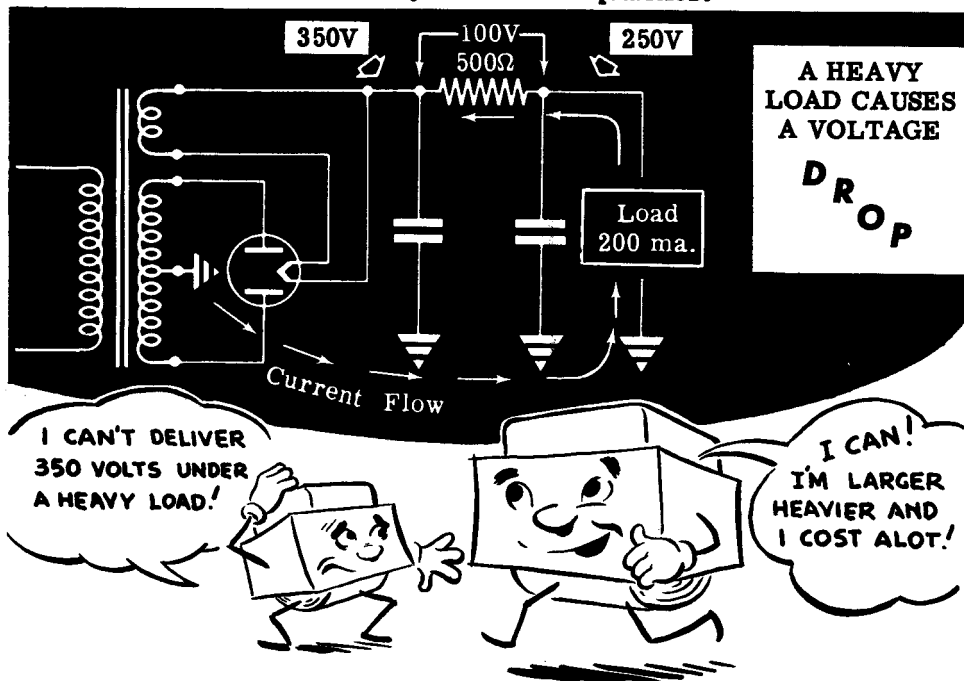



## FILTER CIRCUITS

### The Faults of RC Filters (continued)

You have seen that one fault of the RC filter is that it causes a large voltage drop across the filter resistor which means that the transformer must put out a higher AC voltage in order to compensate for this loss. The second fault of RC filters is even more serious—a small change in the load current causes the B+ output to vary by many volts.

You have read in the introduction to this section that it is important for the B+ voltage output to remain fairly stable in spite of changes in load current. Many types of electronic equipment draw varying amounts of load current from the B+ voltage supply, but the voltage change must remain small in spite of this.

As an example, suppose that you have a unit of electronic equipment that draws 50 ma. from the B+ supply under one set of conditions, and then the conditions change so that 100 ma. are drawn from the B+ supply. First you have 50 ma. flowing through the 500 ohm filter resistor and then you have 100 ma. flowing through that same resistor. Suppose that the voltage coming out of the filter is 350 volts and 50 ma. are being drawn by the load. The voltage drop across the 500 ohms resistor will be  $E = IR = .050 \times 500 = 25V$ . Suddenly an additional 50 ma. are drawn through the 500 ohm load resistor (making a total of 100 ma.). The result is an increased voltage drop across the 500 ohm resistor.

$$E = IR = 0.100 \times 500 = 50V$$

Since the voltage drop has increased 25V, the output voltage must decrease by the same amount.

The output voltage will decrease from 350V to 325V when the load current increases from 50 to 100 ma.

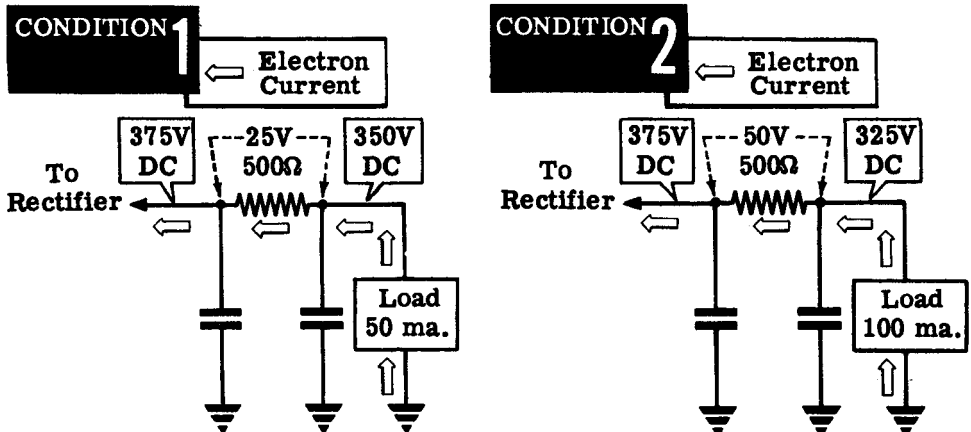

Similarly a change of 100 ma. in the load current will cause the B+ voltage to drop 50 volts. Such a rise and fall in output voltage is very undesirable in electronic equipment. Voltage regulator circuits might be added to compensate for this voltage change due to the filter resistor, but it would require a large and expensive circuit to compensate for changes such as are indicated here.

## FILTER CIRCUITS

### Using a Choke Instead of a Resistor

A resistor can do a fairly good job of filtering because its resistance to AC is higher than the reactance of a filter condenser to AC. When the ripple voltage is placed across this circuit, the AC voltage divides so that only a small part of this ripple voltage appears across the filter condenser and at B+. The DC voltage divides across this circuit so that most of the DC voltage appears across the filter condenser and at B+.

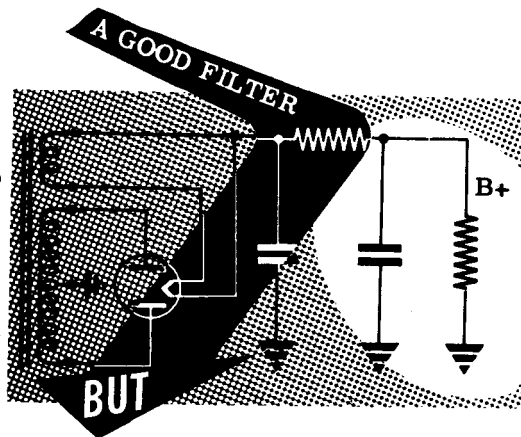

What the filter circuit requires is that the resistor have a high resistance for AC and a low resistance to DC. A resistor presents exactly the same resistance to both AC and DC and cannot meet this requirement. When a filter resistor is used, its size must be a compromise between these two opposing requirements.

There is, however, a certain type of component that will meet this requirement—the filter choke. From your study of AC circuits in Basic Electricity you know that a choke opposes any change of current flowing through it. In other words the inductance of a choke presents a high reactance to AC. Because a choke is made up of many turns of copper wire wound around a core, it also presents a low resistance to DC. A choke has the very qualities that are required to replace the resistor in a filter circuit.

Inductors or chokes, as used in electronic power supplies, are called "filter chokes" because they are used to "choke" out the AC. A 10-henry choke is fairly small in size and will present a reactance of about 7500 ohms to 120 cycle ripple and will have a DC resistance of about 200 ohms. Such a choke has 15 times more reactance to AC than a 500 ohm resistor, and also has less than half its DC resistance. Because of these excellent qualities you will find that chokes are used in the filter circuits of most electronic power supplies. Before you learn about the various combinations of chokes and condensers that are used in filter circuits, suppose you find out about the construction of these components.

A 10-henry FILTER CHOKE

IS 15 TIMES BETTER THAN

A 500-ohm RESISTOR

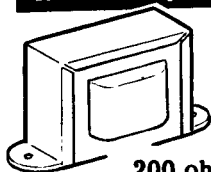

200 ohms

*For Filtering AC*

AND HAS LESS THAN HALF  
THE DC RESISTANCE



500 ohms

# FILTER CIRCUITS

## Filter Chokes

The purpose of a filter choke is to furnish a high impedance to AC ripple voltage and a low resistance to DC current. A choke consists of many turns of copper wire wound around a laminated iron core. The total impedance of the choke depends upon the number of turns of wire and the size, shape and material of the core. The DC resistance of the choke depends upon the total length of wire used and the diameter of the wire.

By increasing the number of turns of wire and by increasing the size of the core, you can raise the impedance; but this also increases the size and the weight of the choke. In addition, the increased length of wire through which the current must flow causes the DC resistance to increase. The only way to decrease DC resistance is either to decrease the number of turns (which lowers the impedance) or to increase the diameter of the wire (which increases the weight).

Every type of choke manufactured is a compromise of size, weight, AC impedance and DC resistance requirements. Because requirements differ according to the equipment, many different sizes of chokes are made. Chokes are rated by the amount of inductance, the DC resistance and the maximum amount of current flow.

### Typical FILTER CHOKES

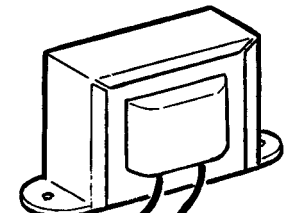

7 henries  
200 ohms  
150 ma.  
2 lbs.

For amplifiers  
and small  
transmitters

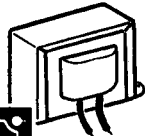

7 henries  
550 ohms  
50 ma.  
1/2 lb.

For small radio receivers

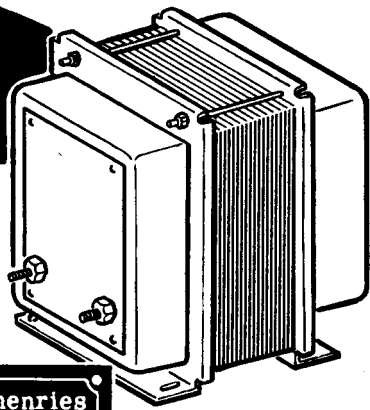

6 henries  
75 ohms  
500 ma.  
24 lbs.

For  
high voltage  
high load  
power supplies

# FILTER CIRCUITS

## The Single-Section Choke and Condenser Input Filters

The single-section choke input filter consists of a filter choke in series with the power supply load and a filter condenser across the load. The DC component of the rectifier output appears across the load. Most of the AC component appears across the high inductive reactance of the choke. Only a small amount of AC appears across the output filter condenser because of its low reactance. Since the load is in parallel with the output filter condenser, very little ripple appears across the load.

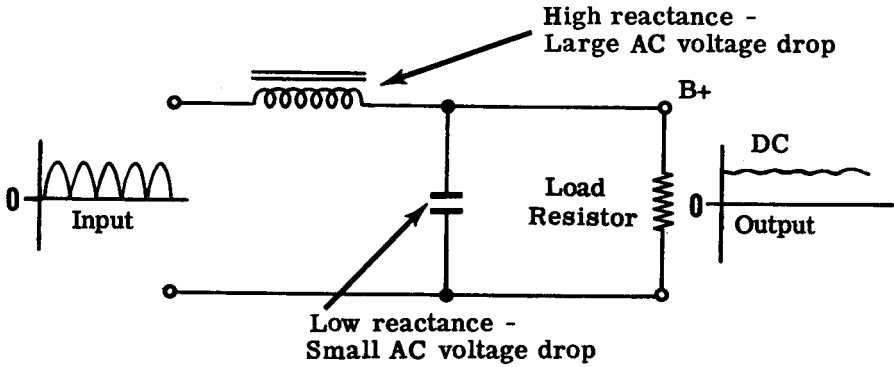

**SINGLE SECTION CHOKE INPUT FILTER CIRCUITS**

A single-section condenser input filter consists of a filter condenser connected across the input terminals of a single-section choke input filter. Because of the shape of the circuit diagram, filter circuits of this type are sometimes called  $\pi$  type filters.

Large values of inductance and capacitance are used in condenser input filters so that they are often called "brute-force" filters. Inductance values of from 10 to 30 henries and capacitance values of from 2 to 16 microfarads are commonly used.

**SINGLE-SECTION CONDENSER INPUT**

*Filter.....  
Circuit*

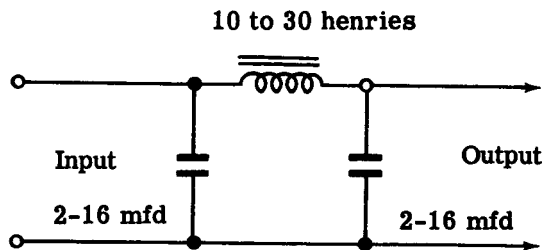

## FILTER CIRCUITS

### The Single-Section Choke Input Filter

You will see that the single-section choke input filter does just a little better job of filtering than the condenser alone. The voltage output of the choke input filter is lower than the voltage output of the condenser alone. This is because the choke builds up a back emf which cancels a part of the voltage coming out of the rectifier. An important feature of the choke input filter is that it limits the peak current flowing through the rectifier tube and, as a result, there is less strain on the tube. The choke input filter also has the characteristic of holding the output voltage quite constant despite load variations. Because of these last two characteristics, choke input filters are used most commonly in power supplies which are subjected to heavy or varying loads. The results of using this type of filter for such loads are a more stable output voltage from the power supply and longer life of the rectifier tube.

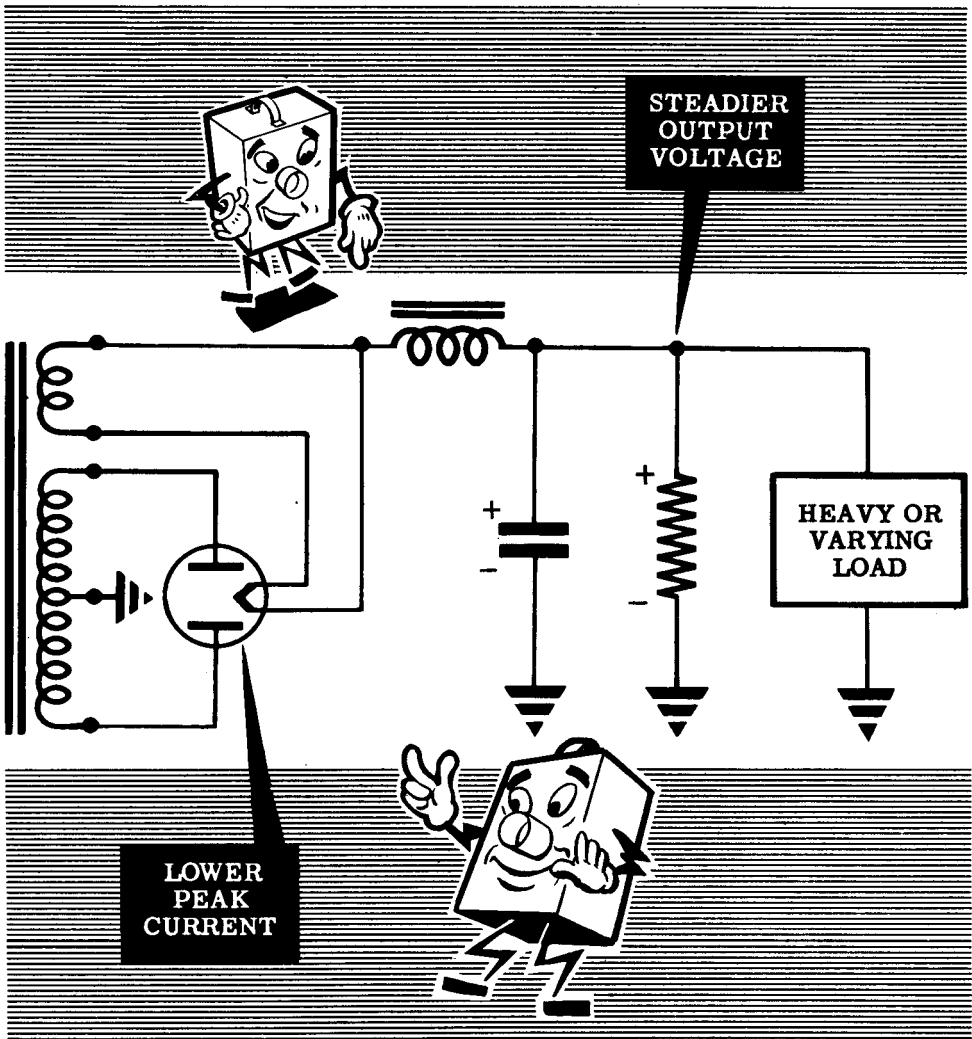

## FILTER CIRCUITS

### The Condenser Input Filter

By comparing these wave forms and voltages with those of the preceding filter circuits, you can see that the condenser input filter does a better job of filtering than any of the others. The voltage output of this filter is larger than it was for the choke input filter because of the charging and discharging action of the input condenser.

However, unlike the choke input filter, this circuit draws large peaks of current from the rectifier tube. The voltage regulation is not as good as it is for a choke input filter. The condenser input filter, very often called a "brute-force" filter, is the most widely used filter circuit for applications where the required amount of DC power is small.

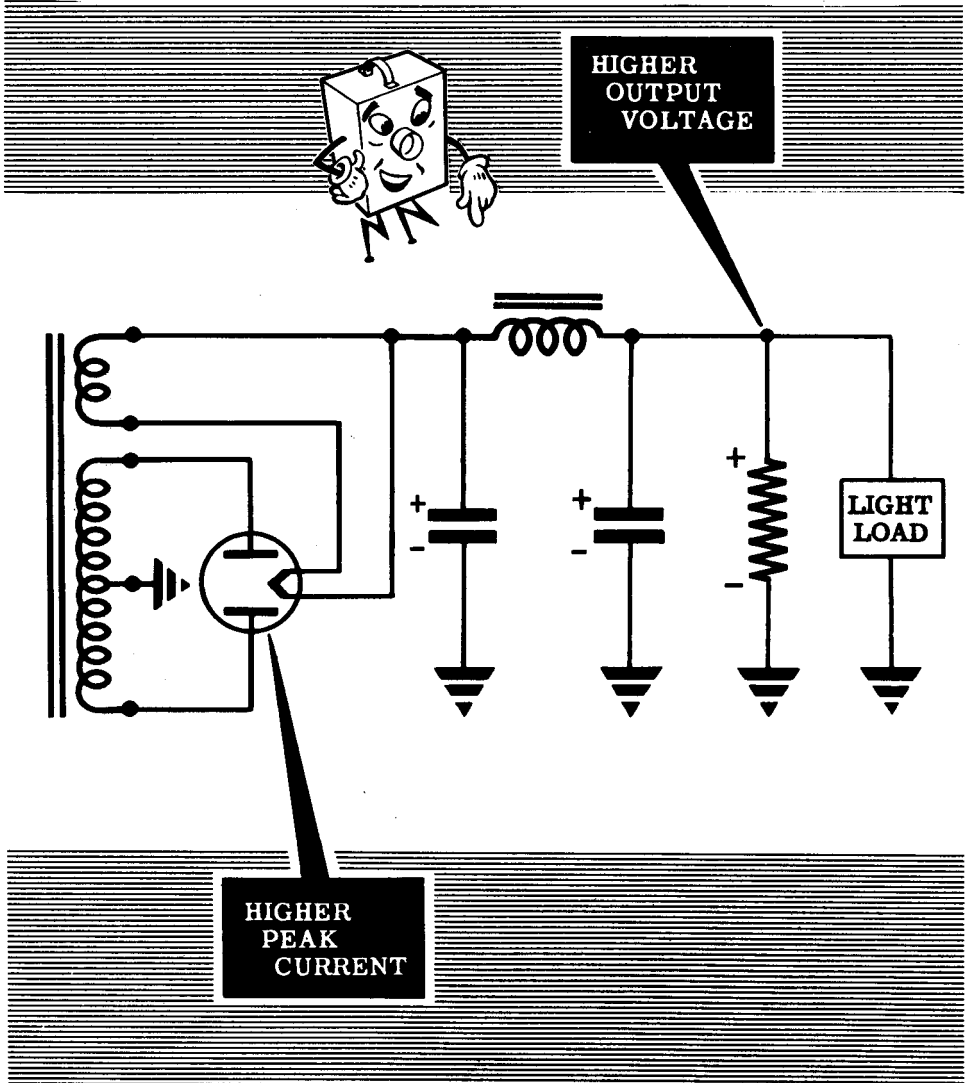

# FILTER CIRCUITS

## The Two-Section Filter

A two-section choke input filter circuit consists of two single-section choke input filters connected in series. Adding another condenser across the filter input terminals changes the choke input circuit into a two-section condenser input filter. Both types of two-section filters reduce the output voltage ripple to a negligible value.

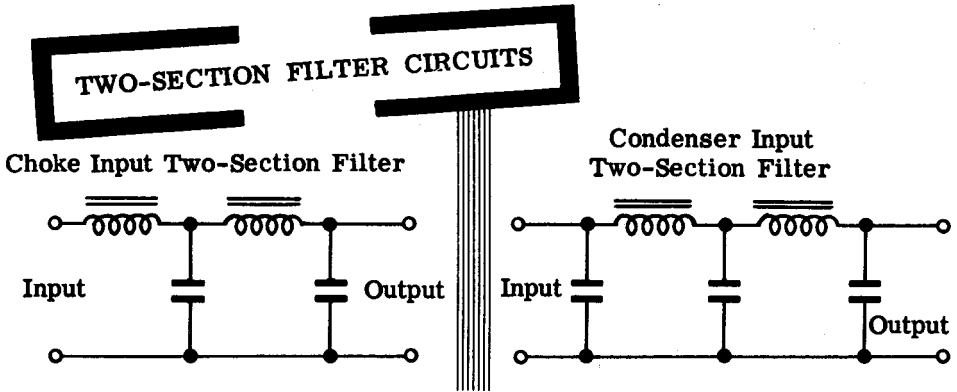

Resonant filter circuits may be used in power supplies although they are usually used in other types of electronic circuits. A series-resonant filter consists of a choke and condenser connected in series across the output terminals of the rectifier circuit. You learned in Basic Electricity (series-resonant circuits) that when a choke and condenser in series are resonant, their inductive and capacitive reactance cancel each other and their total impedance is zero. Therefore, if the components used are resonant at the ripple frequency of the power supply, they will act as a short circuit across the load for that particular frequency.

A parallel-resonant combination of L and C can be used in series with one output terminal of the power supply to provide additional filtering at the ripple frequency. The parallel-resonant circuit offers high impedance to the ripple frequency.

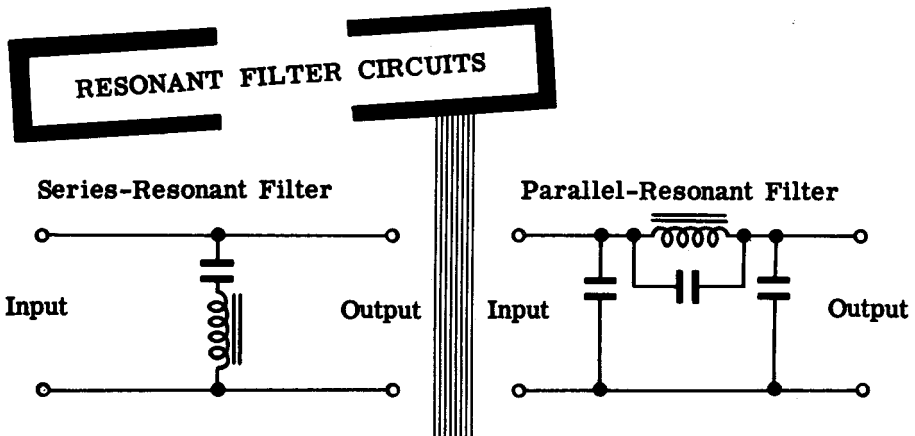

# FILTER CIRCUITS

## Filter Condenser Considerations

When a condenser input filter is used the instantaneous peak current of the rectifier may be much higher than the maximum current delivered to the load. The input condenser across the load circuit acts like a short circuit when a voltage is first applied to it. The initial charging current may exceed the rectifier rating. Series resistors are sometimes used with selenium rectifiers in order to limit the initial charging current of the input filter condenser.

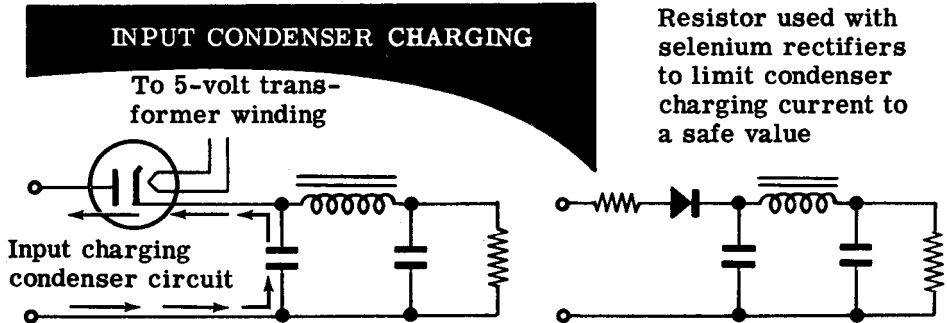

Because of the time lapse between pulses of direct current, the output of a half-wave rectifier requires more filtering than that of a full-wave rectifier and the filtered output voltage will be lower. Filter condensers used in half-wave power supplies are usually from 2 to 4 times as large as those used in full-wave power supplies. Increasing the size of the filter condensers provides additional filtering.

## *Filtering* HALF- AND FULL-WAVE RECTIFIER OUTPUT

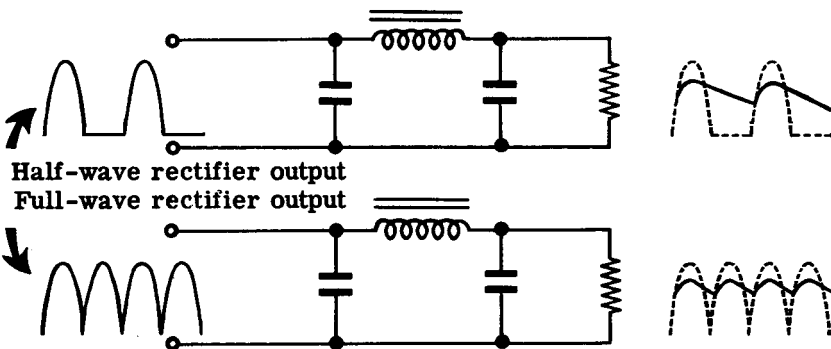

The higher the frequency of the AC input voltage to a power supply the lower the value of the filter condensers required. The time between pulses is shorter at higher frequencies and the inductive action of the choke is greater at higher frequencies.



## FILTER CIRCUITS

### Bleeder Resistors

If the load is entirely removed from a power supply the voltage rises to a value much higher than normal. With no load current there is no DC voltage drop in the circuit and no discharge path for the filter condensers, resulting in a build-up in voltage across the filter condensers to a value approximately equal to the peak AC voltage applied to the rectifier tube.

To prevent soaring of the voltage at no load, resistors are often connected across the output terminals of power supplies. These resistors called "bleeder resistors" provide a discharge path for the filter condensers and also serve as a fixed load to bleed off a constant value of current. The bleeder resistor usually draws about 10 percent of the total rated current output of the power supply.

Since a bleeder resistor prevents sharp increases in voltage output under light or no load conditions it improves the power supply voltage regulation and tends to maintain the output voltage at a constant value regardless of load. This method of voltage regulation is sufficient for most power supply applications but in many cases better voltage regulation is required.

Bleeder resistors dissipate a relatively large amount of power as heat and should be mounted in a well-ventilated position. The resistance value and power rating of the bleeder resistor depend on the maximum voltage and current ratings of the power supply. For example, if a power supply is rated at 300 volts and can supply 100 milliamperes the bleeder current should be about 10 milliamperes and the voltage across the bleeder 300 volts. The bleeder resistance (30,000 ohms) is found by dividing the voltage (300 volts) by the bleeder current (.010 ampere). The power dissipated is equal to the voltage multiplied by the bleeder current. ( $300 \times .01 = 3$  watts). The wattage rating of a resistor should be higher than the power dissipated so that a 30K, 10-watt resistor is used as a bleeder.

### BLEEDER RESISTORS Improve Voltage Regulation

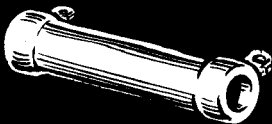
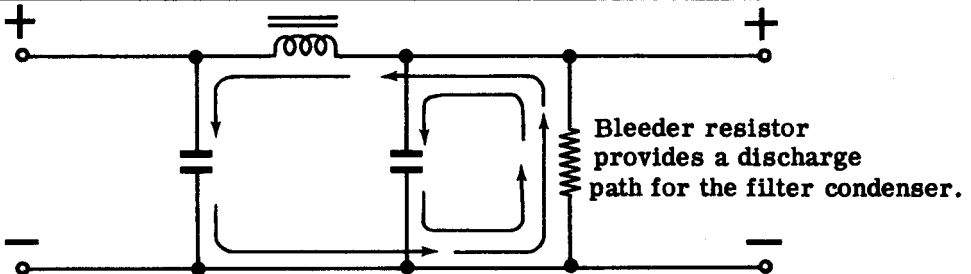

Bleeder resistors provide a continuous load for the power supply.

## FILTER CIRCUITS

### Bleeder Resistors (continued)

Bleeder resistors are sometimes tapped to provide one or more voltages lower than the maximum voltage of the power supply. The bleeder may consist of several resistors connected in series across a source of voltage with various voltages available at the resistor junctions.

When a bleeder is connected directly across the power supply output, the voltage at various points along the bleeder is exactly proportional to the resistance at that point, provided no current is drawn from any of the taps. For example, if a 30,000-ohm resistor tapped at 7,500-ohms, 15,000 ohms and 22,500 ohms is connected across the output of a 300 volt power supply the voltage divides proportionately. At the 15,000-ohm tap the voltage is one half of the total or 150 volts, at the 7,500-ohm tap it is one fourth of the total or 75 volts and at the 22,500-ohm tap it is three fourths of the total or 225 volts. The bleeder current through the resistor is 10 milliamperes.

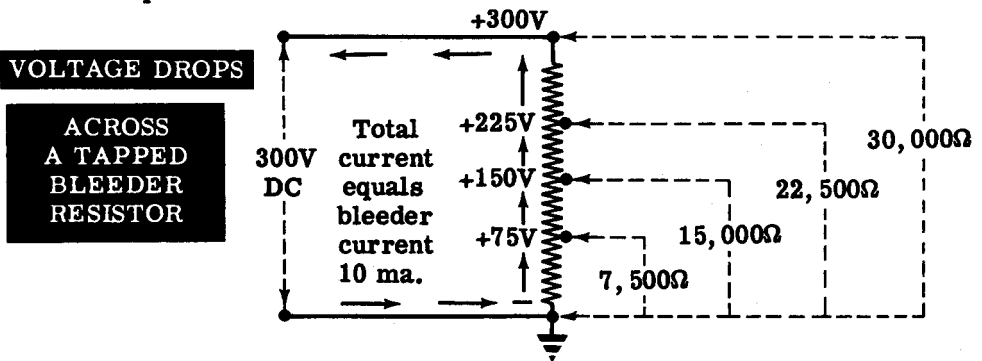

The voltages available at the voltage divider taps depend on the current drawn from each tap and are affected by changes in current supplied by any of the voltage taps. When a load is connected to any of the taps its resistance is in parallel with a portion of the voltage divider. This forms a series-parallel circuit and reduces the total resistance across the circuit resulting in an increase in current drawn from the power supply. The voltage drop in the series part of the voltage divider circuit increases due to the increased current, and the voltage drop and bleeder current for the parallel part of the voltage divider are decreased.

### TAPPED BLEEDER RESISTOR WITH A LOAD CONNECTED

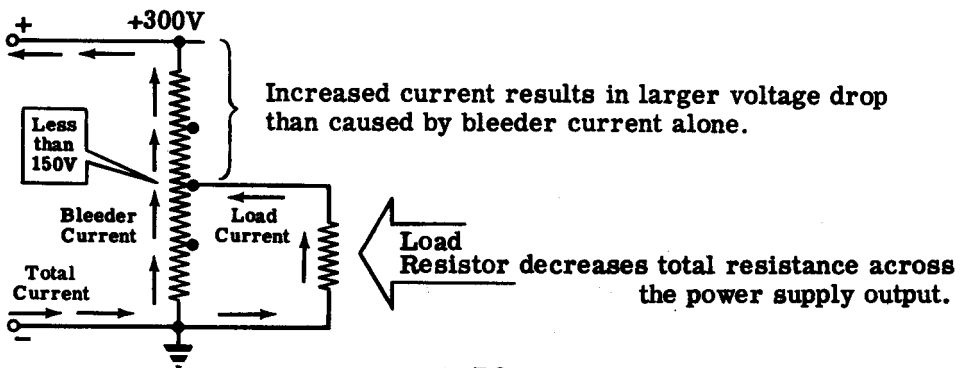

## FILTER CIRCUITS

### Bleeder Resistors (continued)

A typical voltage divider for a 300 volt, 100 milliampere power supply might provide for a bleeder current of 10 milliamperes, a tap at 200 volts to supply 40 milliamperes and a tap at 150 volts to supply 50 milliamperes. To find the resistance values for each part of such a voltage divider circuit the voltage drop and current through each resistor must be found. In the illustration, points A, B, C and D provide the desired voltage taps and the resistance values of  $R_1$ ,  $R_2$ , and  $R_3$  are found as follows:

$R_1$  The voltage drop across  $R_1$  (between points C and D) is 150 volts. The current flow through  $R_1$  is only the bleeder current or 10 ma. then

$$R_1 = \frac{150}{.01} = \underline{15,000 \text{ ohms.}}$$

$R_2$  The voltage drop across  $R_2$  (between points B and C) is 50 volts (150V to 200V). The current flow through  $R_2$  is bleeder current, 10 ma.,

plus the load current, 50 ma., or 60 ma. then  $R_2 = \frac{50}{.06} = \underline{833 \text{ ohms.}}$

$R_3$  The voltage drop across  $R_3$  (between points A and B) is 100 volts (200V to 300V). The current flow through  $R_3$  is the sum of the bleeder current and the current through each load— $10 + 50 + 40 = 100$  ma. then

$$R_3 = \frac{100}{.1} = \underline{1000 \text{ ohms.}}$$

The wattage dissipation of each resistor is found by multiplying the current through the resistor by the voltage drop across it:

$$150 \times .01 = 1.5 \text{ watts for } R_1$$

$$50 \times .06 = 3 \text{ watts for } R_2$$

$$100 \times .1 = 10 \text{ watts for } R_3$$

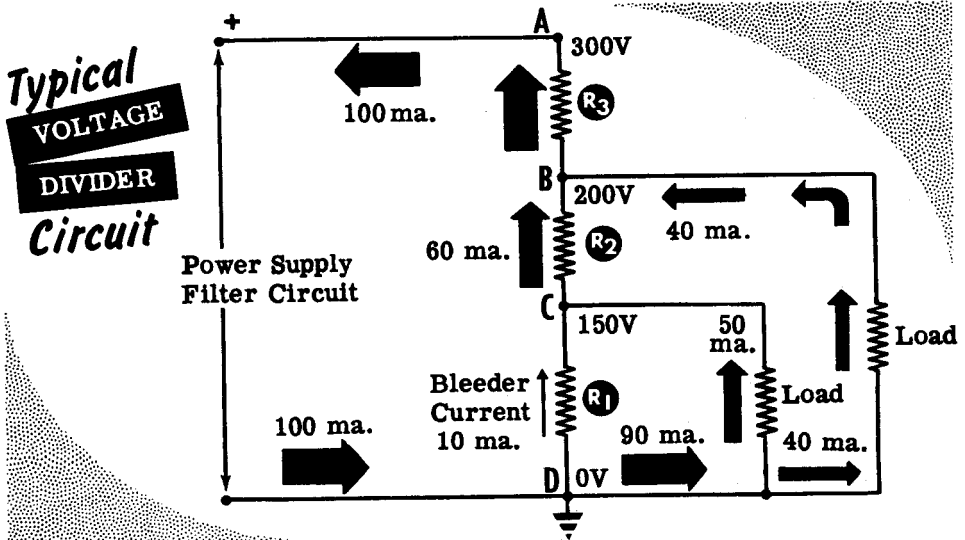

## FILTER CIRCUITS

### Review of Filter Circuits

**FILTER CAPACITORS** — Capacitors used in power supplies to change the pulsating DC output of rectifiers into DC having a relatively slight variation in value. The condenser charges through the rectifier circuit and discharges through the load circuit to help maintain voltage applied to the load at a steady value.

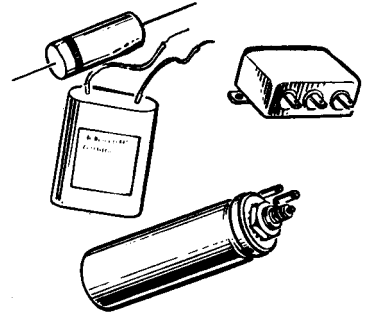

**PAPER FILTER CAPACITORS** — Paper filter condensers are bulky and their value is usually limited to less than 10 mfd. They are not polarized and can be made to withstand very high voltages. There is no appreciable leakage across a paper filter condenser. Oil-impregnated paper condensers are used in high voltage filter circuits.

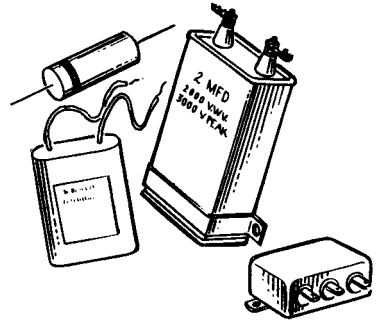

**ELECTROLYTIC FILTER CAPACITORS** — Electrolytics have a high value of capacitance as compared to a paper condenser of the same physical size. They are polarized and are normally constructed to operate at less than 600 volts. There is appreciable leakage across an electrolytic condenser but this effect is usually offset by their large values of capacitance. Electrolytics range in value from 1 to 1000 mfd.

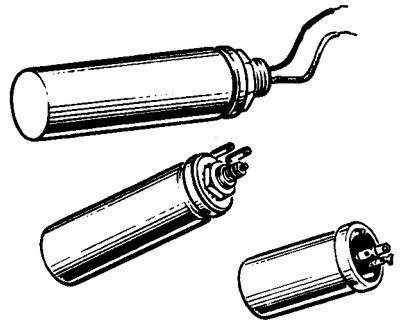

**WET ELECTROLYTIC CAPACITOR** — A condenser consisting of a metal electrode immersed in an electrolytic solution. The electrode and solution are the two condenser plates while an oxide film formed on the electrode is the dielectric. The dielectric film is formed by current flow from the electrolyte to the electrode.

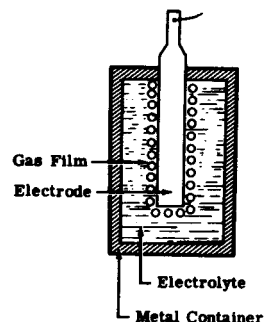

# FILTER CIRCUITS

## Review of Filter Circuits (continued)

### DRY ELECTROLYTIC CONDENSERS

— In a dry electrolytic condenser the electrolyte is a paste. Cloth which is impregnated with the paste is rolled between layers of metal foil which act as the condenser terminals. One metal foil is the positive plate and a film formed on its surface is the dielectric. The electrolyte paste is the negative condenser plate and its terminal connection is made through a layer of metal foil.

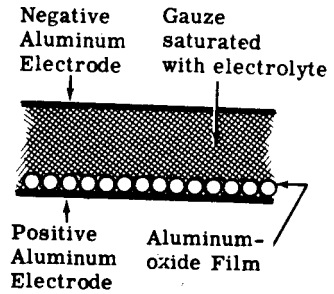

FILTER CHOKE — An iron-core inductance placed in series with the rectifier output. It opposes any change in current flow and reduces the amount of change in the pulsating DC output of the rectifier circuit.

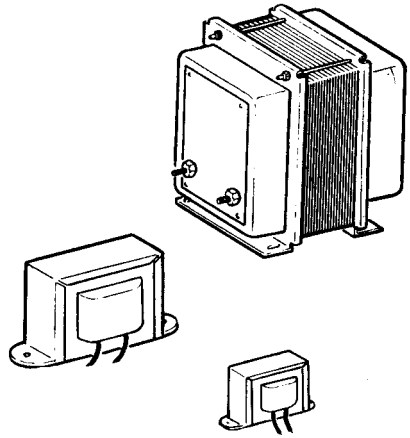

### CHOKeless POWER SUPPLY FILTER

— A low current power supply filter circuit in which resistors are used in place of filter chokes. Resistors are used to save weight, space and cost.

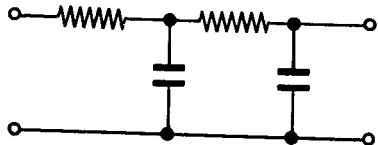

# FILTER CIRCUITS

## Review of Filter Circuits (continued)

### SINGLE-SECTION CHOKE INPUT FILTER

**FILTER** — A filter circuit consisting of a filter choke connected in series with the rectifier output and a filter condenser connected across the output terminals. The output voltage ripple is between 3 and 10 percent of the DC output voltage.

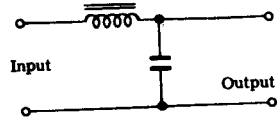

### SINGLE-SECTION CONDENSER INPUT FILTER

**FILTER** — A filter circuit consisting of a filter choke connected in series with the rectifier output and two filter condensers, one connected across the filter input and the other across the filter output terminals. The output voltage ripple is less than that of a single-section choke input filter and the voltage output is higher than that of a choke input filter.

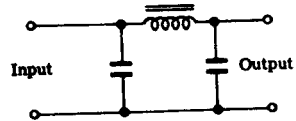

### TWO-SECTION CHOKE INPUT FILTER

— A filter circuit consisting of two single-section choke input filters connected in series. The output ripple is a negligible value for most power supply applications.

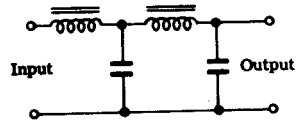

### TWO-SECTION CONDENSER INPUT FILTER

**FILTER** — A two-section choke input filter with an additional filter condenser connected across the filter input terminals. The voltage output is increased as compared to a choke input filter and the ripple is reduced.

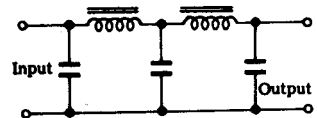

# VOLTAGE REGULATOR CIRCUITS

## Voltage Regulation

By this time you understand the theory of operation of rectifier circuits and filter circuits. You appreciate the importance of maintaining the power supply in good working order so that the complete electronic equipment may be able to do its job.

Now you are going to study voltage regulated power supply circuits which are required to do specialized jobs that the ordinary general purpose power supply cannot do. Like other circuits you will use, voltage regulator circuits range from very simple circuits using only one or two parts to very complex circuits requiring many components. However, all of these circuits operate in the same way as the basic regulator circuits.

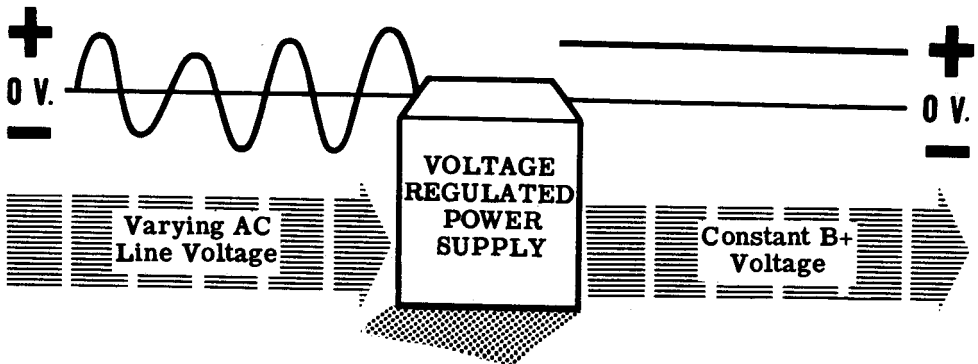
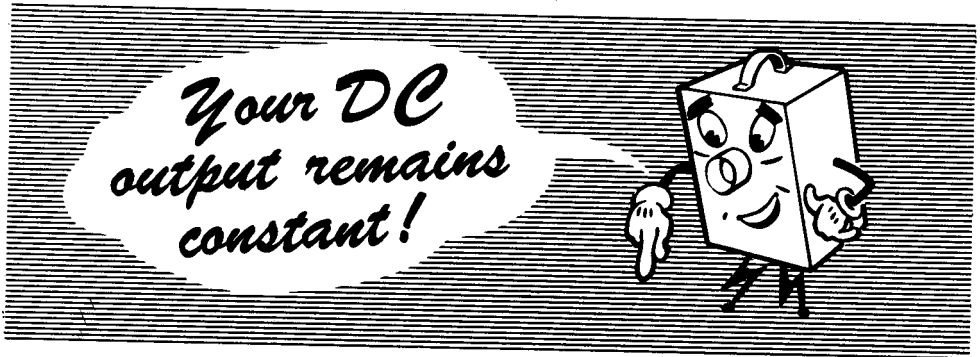

## VOLTAGE REGULATOR CIRCUITS

### Voltage Regulation (continued)

You already know the two most important factors which affect the B+ voltage output in a conventional power supply. When the AC line voltage goes up, the B+ output voltage goes up; and, when the AC line voltage goes down, the B+ output voltage goes down. Also, when there is a small current drain out of the B+ terminal, the B+ voltage is higher than when there is a large current drain. What you want to know now is how the voltage regulator circuit overcomes both these problems.

If you connect a potentiometer across B+ and ground in any conventional power supply, you have a perfect hand-operated voltage regulator.

Assume that you have a 1000-ohm potentiometer and a power supply with a B+ of 100 volts. Also assume that you want a steady output voltage of 50 volts. You first adjust your potentiometer so that the center tap is right at the middle of the potentiometer resistance. If the B+ voltage rises momentarily due to an increase in AC line voltage or a decrease in B+ current drain, all you do is move the tap closer to ground (decrease the resistance between tap and ground) until you get 50 volts again. If the B+ voltage falls due to a decrease in the AC line voltage or an increase in B+ current drain, all you do is move the tap away from ground (increase the resistance between tap and ground) until you get 50 volts again.

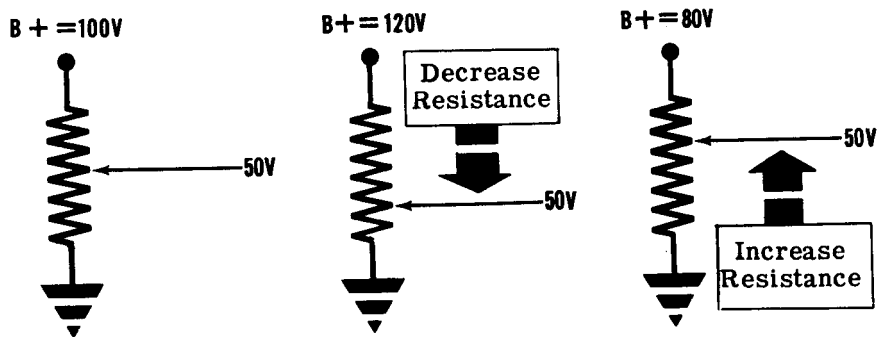

You can see that the hand-operated voltage regulator works very well. You increase or decrease the resistance between ground and the output voltage tap to increase or decrease the output voltage back to the desired value whenever the B+ supply voltage falls or rises for any reason.

The main fault with this method is that it is too slow. First, the output voltage must change. Then you must notice that it has changed, and then you must increase or decrease the resistance between the voltage tap and ground to get back the desired voltage output. When you consider that there are many electronic circuits in a radar system which must have a steady voltage, you can see that many men would be needed to keep them all regulated.

The voltage regulator circuit solves all your problems! The voltage regulator tube automatically increases or decreases its internal resistance as the B+ supply voltage falls and rises, so as to maintain a constant voltage across itself.



## The Voltage Regulator Tube

The voltage regulator tube consists of a plate and a cathode placed in an envelope containing a gas at low pressure. There is no filament and, therefore, the tube is known as a cold cathode type tube. The radio symbol for the tube is as illustrated. The dot inside the envelope indicates the presence of a gas.

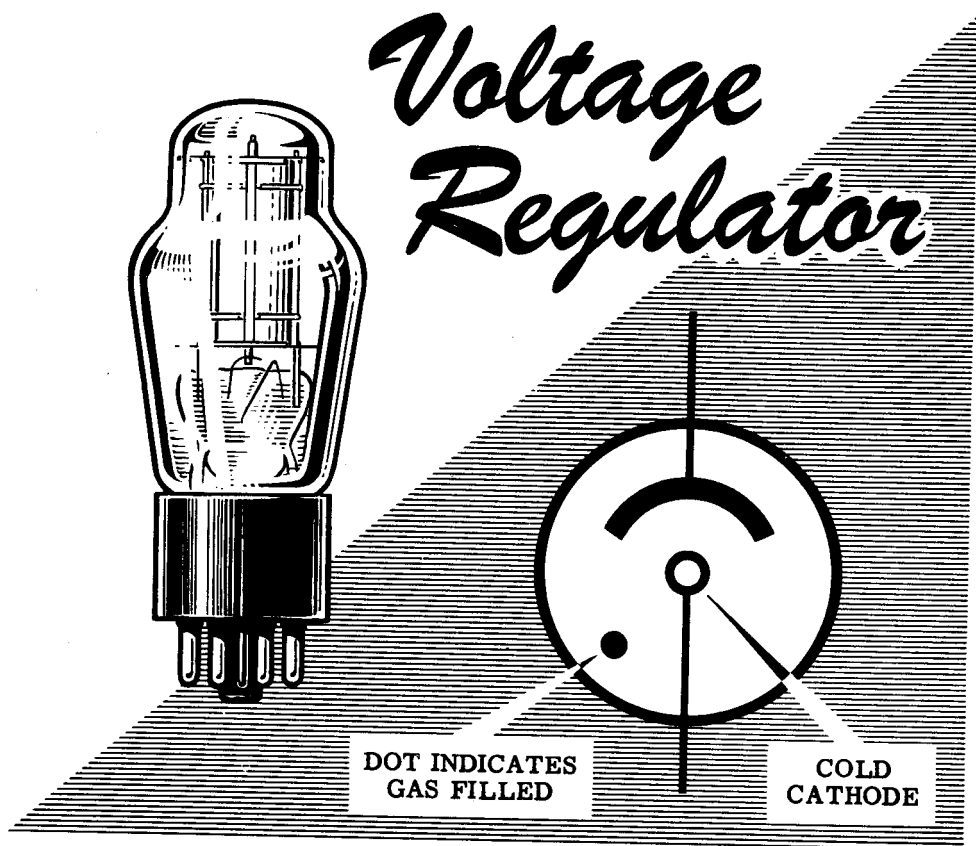

When a large enough potential is applied between the cathode and the plate, the gas in the tube conducts and electrons flow from cathode to plate. Conduction is characterized by a bluish glow inside the tube—the heavier the conduction the brighter the glow.

The numbering system used for voltage regulator tubes has been changed in recent years. The VR-150/30, the VR-90/30 and the VR-75/30 are old numbers no longer used. The term "VR" meant voltage regulator; the first number, "150" etc., stood for the operating voltage of the tube—the voltage at which it regulated. The last number represented the maximum rated current that could pass through the tube without damaging it. In all regulator tubes there is also a minimum operating current of about 5 ma. The tube will stop conducting if the current through it drops below this value. A wide range of regulated voltages can be had by using any of the voltage regulator tubes singly or in series combinations.

# VOLTAGE REGULATOR CIRCUITS

The Voltage Regulator Tube (continued)

The new numbering system for VR tubes is as follows:

Tube Type	DC Operating Voltage	Current Range Ma.
OA2	151	5 to 30
OA3	75	5 to 40
OB2	108	5 to 30
OC3	108	5 to 40
OD3	153	5 to 40
874	90	10 to 50
991	59	0.4 to 2.0

**VR  
TUBE  
DIAGRAMS**

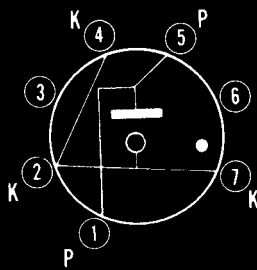

OA2  
OB2

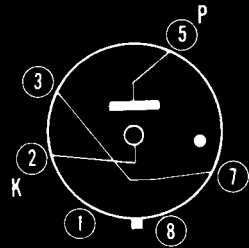

OA3  
OC3  
OD3

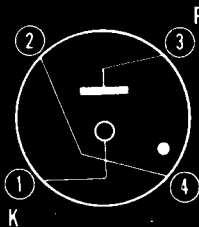

874

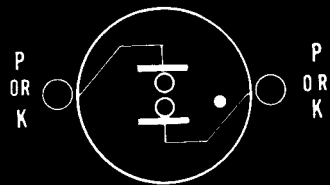

991

**K = Cathode**

**P = Plate**

Under this new system there are available a larger variety of DC operating voltages and current ranges.

The VR tube is a diode which consists of a thin vertical rod held in position inside of a thin metal cylinder. The air is removed from the tube envelope and is replaced by a small quantity of neon or helium gas mixed with a small quantity of argon gas. As long as the current flow through the tube is kept within the listed limits the plate voltage of the tube will change very little.

If operating voltages higher than those listed above are required, two or more VR tubes may be connected in series. In this case the operating voltage will become the sum of all the operating voltages of the tubes connected in series. Parallel operation is used when a larger current is required.

# VOLTAGE REGULATOR CIRCUITS

## A Simple VR Tube Circuit

Here is an example of how a VR tube is used in a typical circuit. Suppose that you have a power supply with an output voltage of 340 volts DC. You need to supply voltage to a special circuit that needs 150 volts DC with a current variation of from 10 to 30 milliamps. This circuit requires that the 150 volts DC be kept constant in spite of the current change.

Since you want a constant voltage of 150 volts DC with a maximum current drain of 30 milliamps, an OD3 (VR-150) will meet your requirements. Here are the operating characteristics of the OD3 (VR-150) as listed by the manufacturer - note that they meet your requirements:

- DC power supply voltage . . . . . 185 volts min.
- DC starting voltage . . . . . 160 volts
- DC operating voltage . . . . . 153 volts
- DC operating current . . . . . .5 to 40 ma.

For a current variation of from 5 to 30 ma. the voltage will change 2 volts.

For a current variation of from 5 to 40 ma. the voltage will change 4 volts.

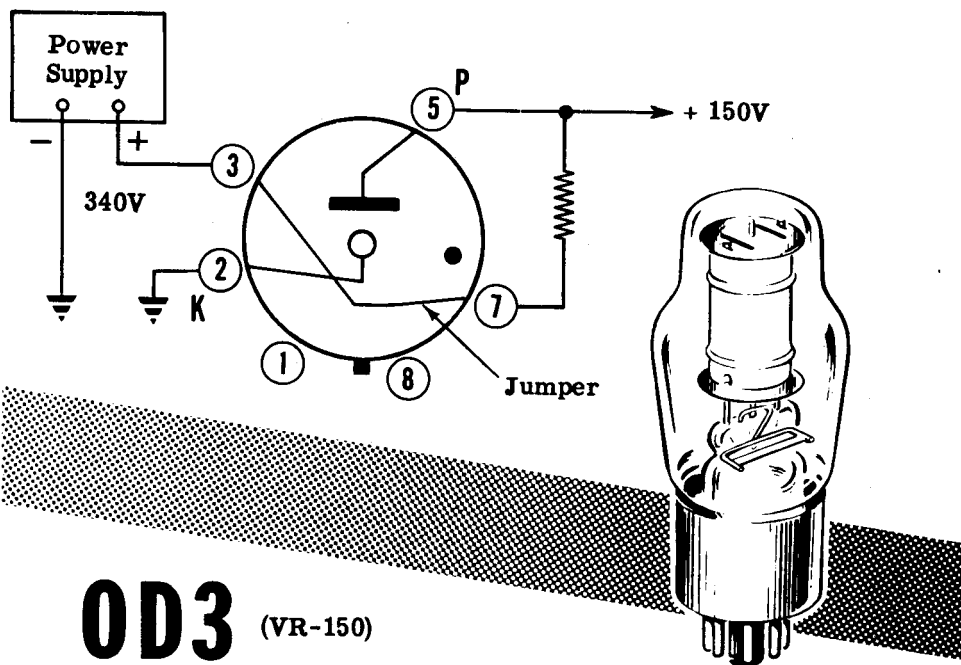

# OD3 (VR-150)

Notice that there is a "jumper connection" between pins 3 and 7 inside the tube. If pins 3 and 7 are wired in series with the circuit, this jumper will act as a switch. When the VR tube is pulled out, the circuit requiring the 150 volts will be disconnected from the power supply. If this jumper were not connected as a switch and the VR tube were pulled out, the 150 volt circuit would receive more than 150 volts—resulting in damage to its components or in improper operation.

## VOLTAGE REGULATOR CIRCUITS

### A Simple VR Tube Circuit (continued)

In order to illustrate the circuit described on the previous sheet, the VR tube is connected to the power supply like this:

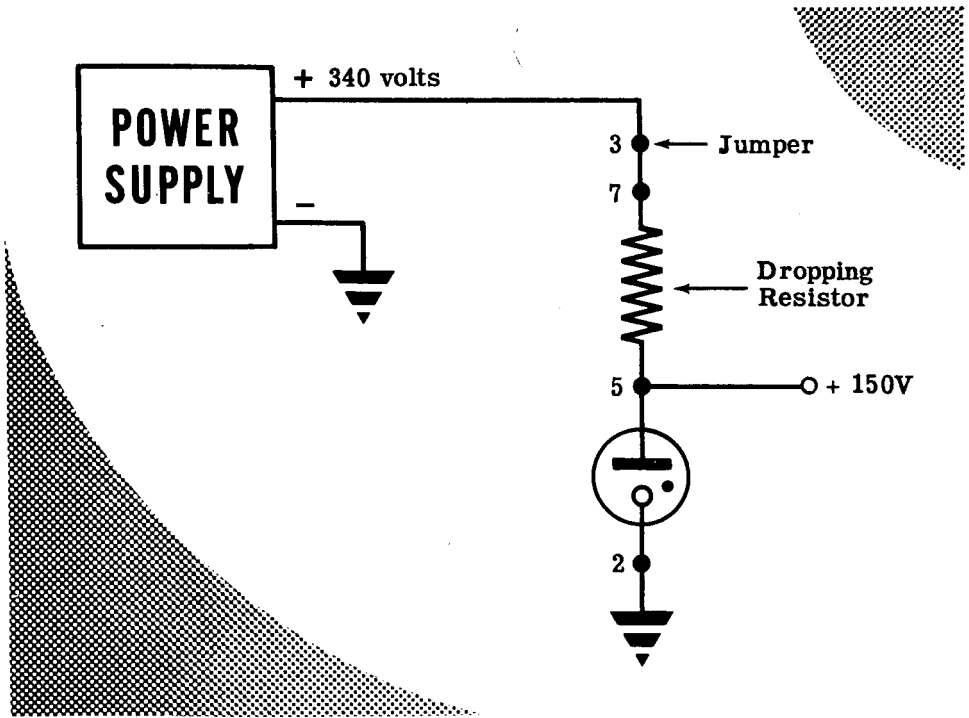

Note that the 150 volt point is disconnected from the power supply if the VR tube is pulled out.

In order to determine the size of the dropping resistor, you must begin with a condition when no load is connected to the 150 volt output terminal. You must then adjust the size of the dropping resistor so that the maximum current (40 ma.) will flow through the VR tube. You already know that the output of the power supply is 340 volts, so the voltage across the resistor will have to be 340 - 150 or 190 volts. For these current and voltage conditions the size of the resistor is calculated from Ohm's law:

$$R = \frac{E}{I} = \frac{190V}{0.04A} = 4750 \text{ ohms}$$

The wattage of the resistor is found from the power formula  
 $W = EI = 190V \times 0.04A = 7.6 \text{ watts.}$

The resistance you want according to the above results is a resistor of 4750 ohms rated at 7.6 watts. Such a resistor is not available except on special order. The nearest standard value of wire wound resistance available is 5000 ohms. This resistor would allow 38 ma. to flow through the tube, which is suitable for your purposes. A 10 watt resistor could be used but a 25 watt resistor would probably be best since the size and cost are not much more and the danger of burnouts would be reduced.

# VOLTAGE REGULATOR CIRCUITS

## Voltage Regulation When Load Current Varies

Now that you have the details of a VR tube circuit worked out, suppose you find out how it operates to keep the output voltage stable at 150 volts in spite of a change in output current. In order to do this, the VR tube increases and decreases its resistance to adjust to changes in load and supply voltage.

When no load is attached to the 150 volt output, 38 ma. will flow through the tube. Since the current flowing through the tube is within the rated value, the VR tube adjusts its internal resistance so that the voltage at the plate is 150 volts.

**A SIMPLE VR TUBE CIRCUIT WITH NO LOAD**

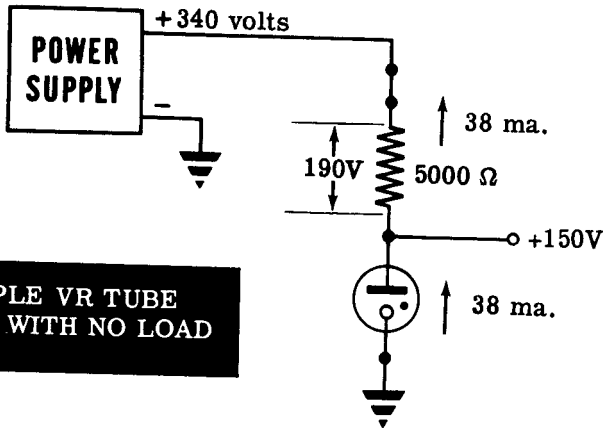

Suppose you attach an 8 ma. load to the 150 volt terminal. Of the 38 ma. flowing through the dropping resistor, 8 ma. flows through the load and 30 ma. flows through the VR tube. Since the VR tube current is yet within the rated range of 5 to 40 ma., the VR tube adjusts its internal resistance so that the plate voltage remains at 150 volts.

**8 ma. LOAD  
VOLTAGE OUTPUT  
REMAINS THE SAME**

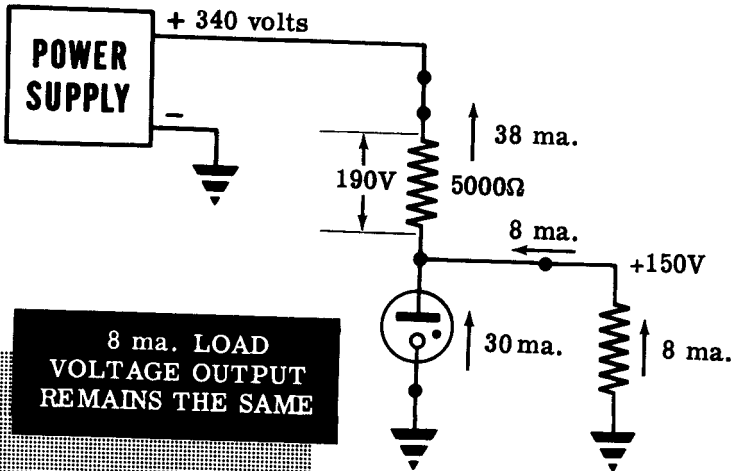

## VOLTAGE REGULATOR CIRCUITS

### Voltage Regulation When Load Current Varies (continued)

If you now increase the load on the 150 volt terminal to 18 ma., 20 ma. will flow through the VR tube, and the output voltage will remain at 150 volts. As long as the current flowing through the VR tube is within the range of 5 to 40 ma., the tube is able to adjust its internal resistance so as to keep the plate voltage essentially at 150 volts.

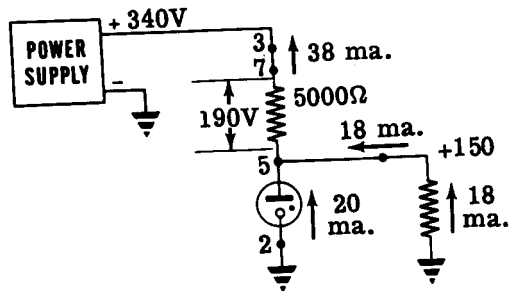

You may increase the load on the 150 volt output terminal until the current through the load reaches 33 ma. At this load, only 5 ma. will flow through the VR tube—this is the minimum current that may flow through the VR tube and still keep the output terminal at 150 volts. Any further increase in load current will cause less than 5 ma. to flow through the tube and it will "go out" or cease glowing. From this point on the VR tube will have no effect on the output voltage, and the output voltage will be determined only by Ohm's Law.

For a load of 38 ma. on the output terminal the voltage drop across the dropping resistor will be:

$$E = IR = .038 \times 5000 = 190 \text{ volts}$$

Subtracting the voltage drop across the resistor from the voltage of the power supply gives you the following voltage at the plate of the tube:

$$340 - 190 \text{ volts} = 150 \text{ volts}$$

For a load of 40 ma. on the output terminal the voltage drop across the dropping resistor will be:

$$E = IR = .040 \times 5000 = 200 \text{ volts}$$

And the voltage at the plate of the tube will be:

$$340 \text{ volts} - 200 \text{ volts} = 140$$

Similarly the following loads on the output terminal will result in the following voltages at the output terminal.

Load Current	42 ma.	44 ma.	46 ma.	48 ma.
Output Voltage	130V.	120V.	110V.	100V.

You see, therefore, that as long as the voltage regulator tube conducts its rated current the voltage remains constant. The voltage remains essentially at 150V in spite of a change in load of from 0 to 33 ma. Once the current through the VR tube becomes less than the minimum required, the tube goes out of action and Ohm's law determines the output voltage. Once Ohm's law determines the output voltage, a change in load of only 2 ma. will cause a voltage change of 10V at the output terminal.

# VOLTAGE REGULATOR CIRCUITS

## Voltage Regulation When Power Supply Voltage Varies

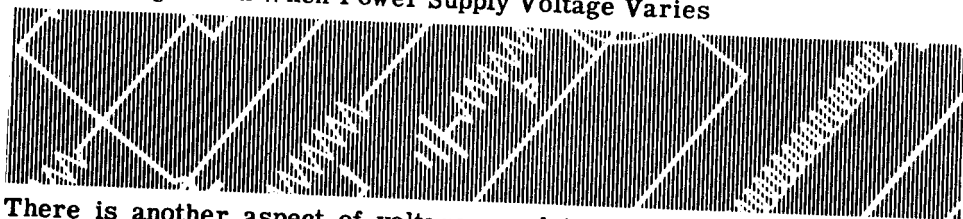

There is another aspect of voltage regulator circuits that has not been considered so far—how the voltage regulator circuit maintains a constant voltage output when the power supply voltage changes. The power supply B+ voltage will rise when the line voltage rises, and it will fall when the line voltage falls. In addition there usually are other circuits connected to the power supply B+ output voltage, in addition to the voltage regulation circuit. When these other circuits draw more current from B+, the voltage drops; and when these other circuits draw less current from B+, the voltage rises. The voltage regulator circuit must put out a constant voltage output at the plate of the VR tube in spite of these changes in B+ voltage.

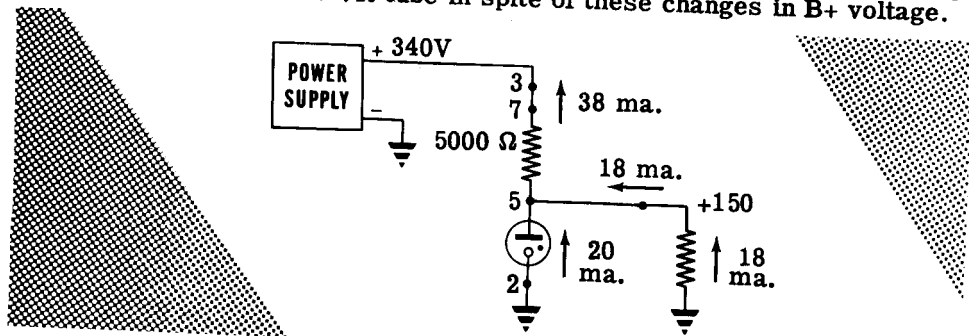

Under the operating conditions shown, 38 ma. flow through the dropping resistor, 20 ma. flow through the VR tube, and 18 ma. flow through the load. If the B+ voltage were to rise to +360 volts, the VR tube would have to adjust its internal resistance so that its plate voltage remained at 150 volts. Let's see if the VR tube is able to make this adjustment.

Under these conditions the top of the dropping resistor would be at +360 volts and the bottom would be at +150 volts. This means that there will be 210 volts across the resistor and the current flow through that resistor will be determined by Ohm's law as follows

$$I = \frac{E}{R} = \frac{210}{5000} = .042 \text{ amps} = 42 \text{ ma.}$$

Since the load draws 18 ma. at 150 volts, the remainder of the current (42 ma. - 18 ma. = 24 ma.) must flow through the VR tube. The VR tube is designed to do its job of regulating if the current flow through it remains between 5 and 40 ma. The VR tube can adjust for this B+ voltage change and still maintain the voltage at its plate at 150 volts.

In order for the circuit to fail in its job, the B+ voltage would have to go up to over 440 volts. At this point there would be 290 volts across the dropping resistor and 58 ma. total current through this resistor. The load current would be 18 ma. and the VR tube current would be 40 ma. Any further increase in B+ voltage would cause over 40 ma. to flow through the VR tube and it would be damaged by the excessive current.

## VOLTAGE REGULATOR CIRCUITS

### Voltage Regulation When Power Supply Voltage Varies (continued)

Now that you have examined what happens when there is a rise in the B+ voltage supplied to the voltage regulator circuit, suppose you find out what happens when this B+ voltage falls.

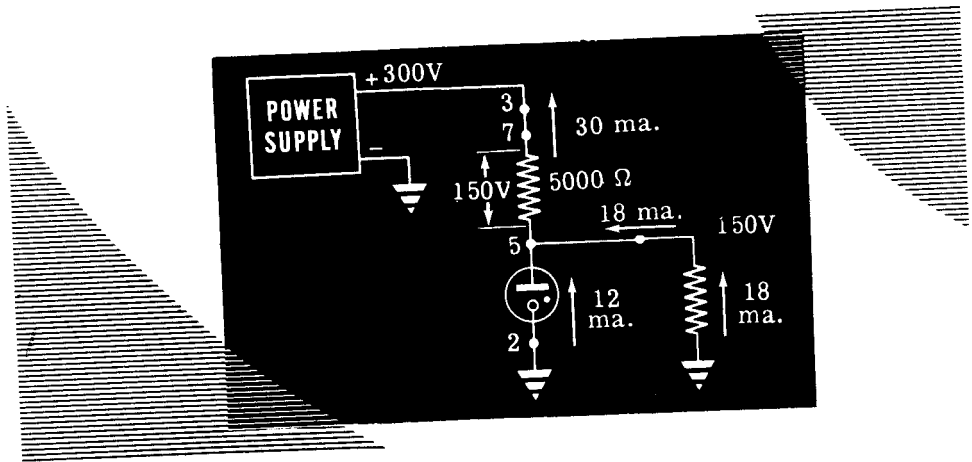

If the B+ voltage were to fall to 300 volts, the VR tube would have to adjust its internal resistance so that the plate voltage remains at 150V. Let's see if the tube can make this adjustment. The voltage across the dropping resistor is 300 volts - 150 volts = 150 volts. The current through the dropping resistor is:

$$I = \frac{E}{R} = \frac{150}{5000} = .030 \text{ amps} = 30 \text{ ma.}$$

The load draws 18 ma. and the remainder of the current (30 ma. - 18 ma. = 12 ma.) flows through the VR tube. The VR tube will do its job as long as the current flow through it remains between 5 and 40 ma. The VR tube can adjust for the drop in B+ voltage and still maintain 150 volts at its plate.

In order for the circuit to fail in its job the B+ voltage would have to drop below 265. At this point there will be 115 volts across the dropping resistor and 23 ma. total current through this resistor. The load current would be 18 ma. and the VR tube current would be 5 ma. Any further drop in B+ voltage will cause less than 5 ma. to flow through the VR tube, and it will stop functioning. The voltage at the plate will then be determined only by Ohm's law as applied to the B+ voltage and the resistance of the dropping resistor.

You have examined the principles behind the operation of the voltage regulator circuit. You have seen that the voltage on the VR tube plate will remain essentially constant as long as the current limitations of this tube are not exceeded. By using a voltage regulator circuit of this type you can get a constant voltage output in spite of fairly large changes in power supply voltage and in spite of sizeable changes in current drain from the regulated source.



# VOLTAGE REGULATOR CIRCUITS

## Review

**VOLTAGE REGULATION** — Voltage regulation is a term used to express how well a power supply maintains a constant voltage output in spite of changes in line voltage and load current. There are certain types of electronic circuits that will not operate properly if the supplied voltage varies more than a few volts. The voltage supply to these circuits requires the addition of a voltage regulator circuit which will maintain an essentially constant voltage regardless of line voltage and load current changes.

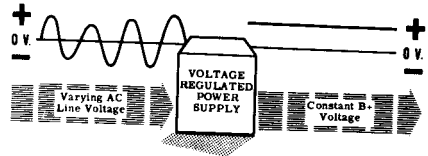

## **VOLTAGE REGULATOR TUBE** —

The voltage regulator (VR) tube contains a plate and a cathode with no filament—both enclosed in a glass envelope containing a gas at low pressure. When a large enough voltage is applied across the tube, a current is conducted through the tube. As long as the current flowing through the tube remains within the limits listed by the manufacturer, the voltage at the plate will remain essentially constant.

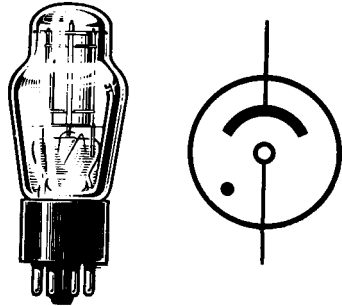

**VR TUBE CIRCUIT** -- The simplest (and very widely used) voltage regulator circuit consists of a voltage dropping resistor and a VR tube placed in series across the power supply output and ground. The regulated voltage is taken from the plate of the VR tube. The load current and the VR tube current both flow through the dropping resistor, and the VR tube current changes along with the load current so as to keep the dropping resistor current constant.

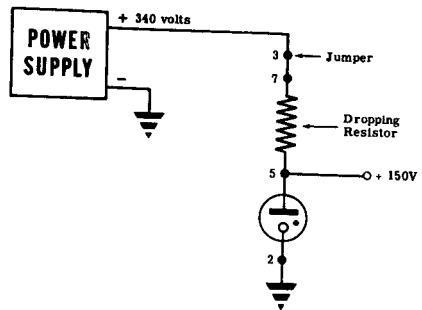

**VR TUBE JUMPER** — The purpose of the jumper in a VR tube is to prevent unregulated voltage from reaching a special electronic circuit if the VR tube is pulled out. Without the jumper, unregulated voltage would reach the circuit, causing improper operation and possible damage. Pulling out the VR tube removes the jumper and disconnects the voltage from the special circuit.

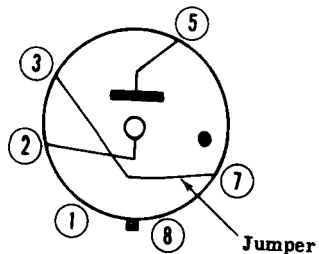

## OTHER TYPES OF POWER SUPPLY CIRCUITS

### Why the Need for Other Types of Power Supplies

Nearly every power supply you will find in electronic equipment will consist of a half- or full-wave rectifier with a choke or a condenser input filter.

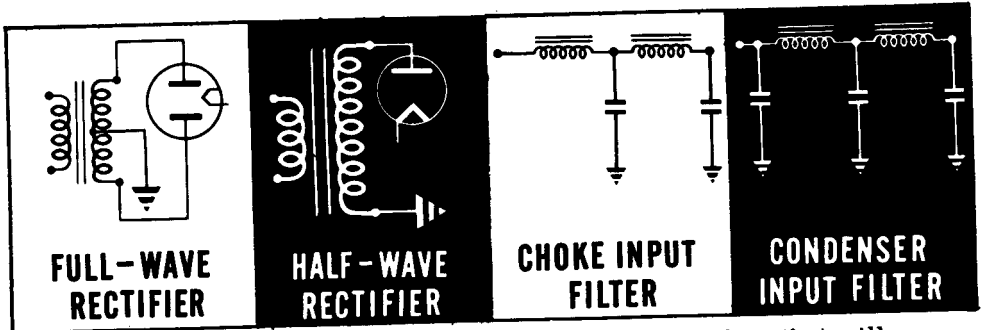

However, there are certain other types of power supplies that will occasionally be found in special types of electronic equipment. These special types of power supplies will be found in equipment upon which are placed size or weight limitations, or limitations as to the type of voltage available from the power line—if a power line is available at all.

Size or weight limitations may require that no transformers or chokes be used in the power supply. In certain cases it may be necessary to eliminate the bulky rectifier tube. There will be cases where AC voltage is not available—requiring the use of a 110 DC line. At some time or another you may even find that 110 DC voltage is not available and only a low voltage DC line or low voltage batteries are available.

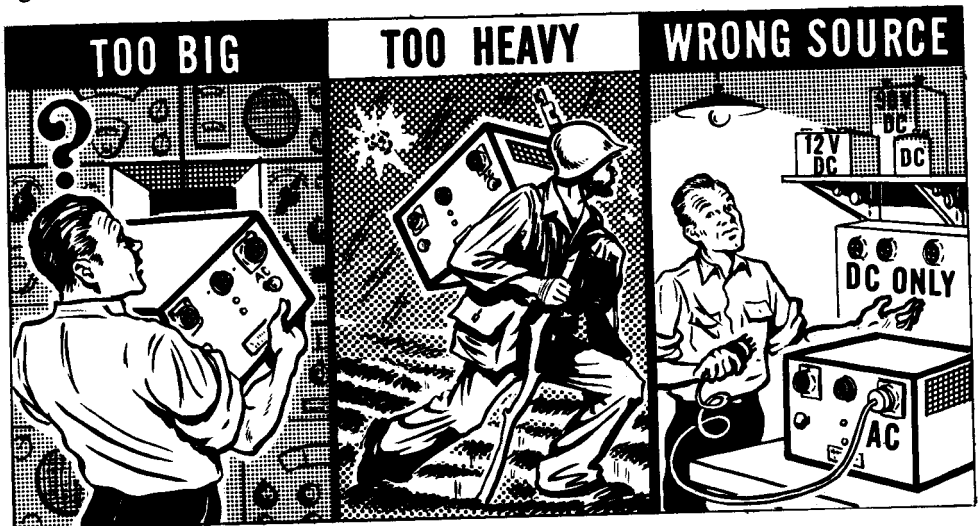

The purpose of this portion of the Power Supply Section is to show you how high voltage DC may be supplied to vacuum tubes under these various restrictions. Even though these power supplies are not common, you should know how they work because you are sure to come across at least several of them in the near future. Learn them now and save yourself future headaches.

## OTHER TYPES OF POWER SUPPLY CIRCUITS

### General Types

The special types of power supplies you will learn about in the remainder of this topic are divided into two main groups:

1. Power supplies which are included in equipment upon which there are size and weight limitations.

In this group are included:

- a. Transformerless power supplies
- b. Transformerless and chokeless power supplies

## .... SIZE AND WEIGHT LIMITATIONS

**TRANSFORMERLESS  
POWER SUPPLIES**

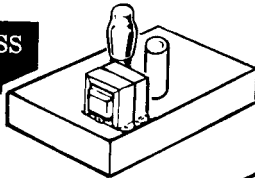

**TRANSFORMERLESS AND  
CHOKELESS POWER SUPPLIES**

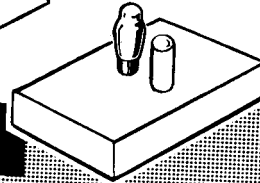

2. Power supplies which are designed for equipment which will have only DC voltage available either from a DC line or from battery sources.

- a. Vibrator power supplies
- b. Motor generators, dynamotors and rotary converters

## .... ONLY DC VOLTAGE

**AVAILABLE**

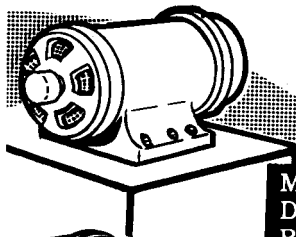

**MOTOR — GENERATORS,  
DYNAMOTORS, AND  
ROTARY CONVERTERS**

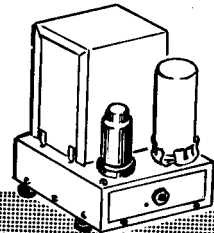

**VIBRATOR POWER SUPPLIES**

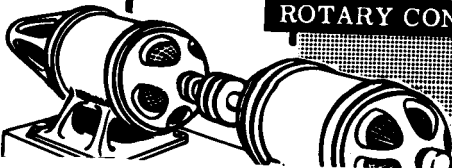

## OTHER TYPES OF POWER SUPPLY CIRCUITS

### Transformerless Power Supplies

Transformerless power supplies are sometimes used in some electronic equipment to save the weight and space of the power transformer. In commercial radios, transformerless power supplies are very often used to save the cost of the transformer as well as to save the space and weight. Nearly any portable radio that you may look into will have a transformerless power supply, and many "console" model radios are made that way too. There are three types of transformerless power supplies in general use—the AC-DC half-wave rectifier, the voltage doubler and the dry metal rectifier power supplies.

#### The AC-DC Half-Wave Rectifier Power Supply

The AC-DC half-wave rectifier power supply is useful only in circuits where the tubes will operate at about 100 volts B+ and with tubes that have high voltage filaments. This circuit will supply about 100 volts B+ and will operate either on AC or DC. The circuit itself is a simple half-wave rectifier circuit usually followed by a condenser input filter—you are acquainted with the operation of both these circuits.

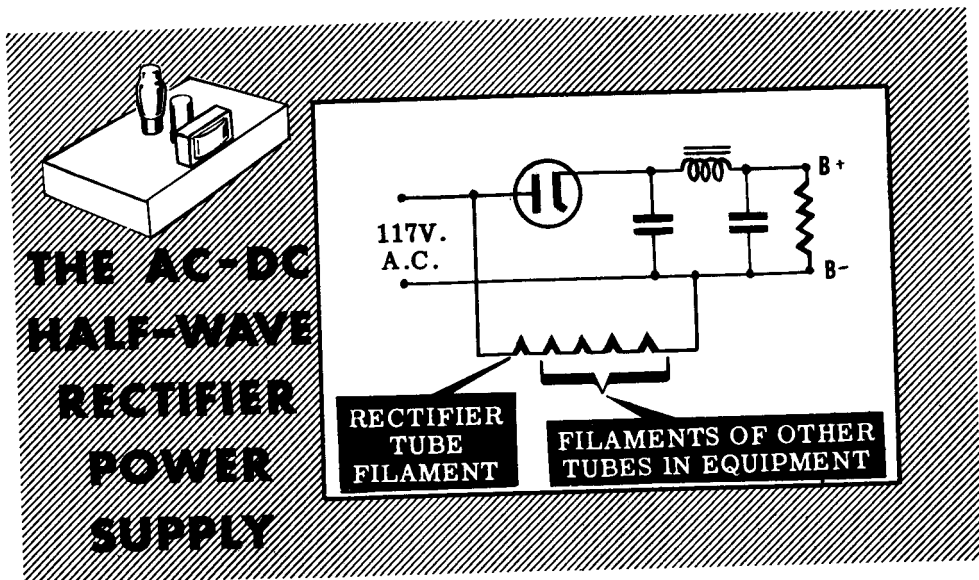

Notice that the filaments of the rectifier tube and the other tubes in the circuit are all connected in series across the power line. As long as all the tubes have the same filament current requirement and as long as the filament voltages add up to approximately the line voltage, the circuit will operate properly. A typical 5-tube portable radio would use a 35Z5 rectifier tube; a 12SA7 first detector, a 12SK7 IF amplifier, a 12SQ7 second detector and a 50L6 audio amplifier. The filament voltages required by these tubes add up to 121 volts ( $35 + 12 + 12 + 12 + 50 = 121$ ) which is close enough to the line voltage.

## OTHER TYPES OF POWER SUPPLY CIRCUITS

### Transformerless Power Supplies (continued)

#### The AC-DC Half-Wave Rectifier Power Supply (continued)

One special thing about this power supply is that it will operate on either AC or DC. If a transformer were included in the circuit, the transformer would burn out (or a protecting fuse would blow) in the event that it was connected to a DC line. In the AC-DC half-wave power supply there is no transformer. When the plate of the rectifier tube is connected to the positive side of a DC line and when the cathode is connected to the negative side of the DC line through the load, the circuit will supply B+ voltage. The rectifier plate will always be positive with respect to the cathode, and a steady stream of electrons will be attracted to the plate—a B+ voltage with very little ripple will appear at the cathode.

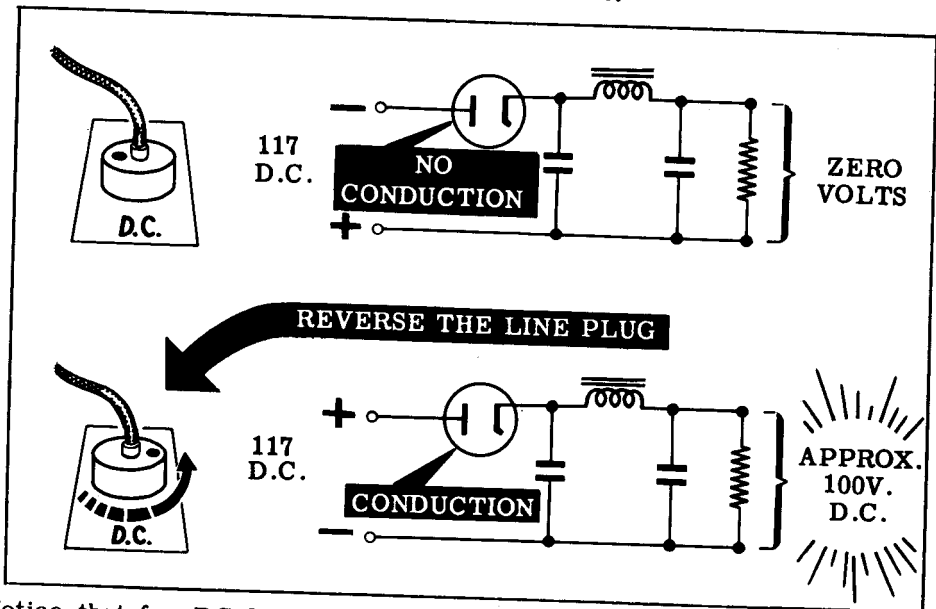

Notice that for DC line operation the plate must always be connected to the positive side of the line and the cathode must always be connected through the load to the negative side of the line. If these connections should be reversed accidentally (because of the use of a non-polarized line plug), the plate of the rectifier will be negative and will attract no electrons from the cathode. The circuit will not work. Whenever a power supply of this type does not operate on a DC line, one of your first checks should be to pull out the line plug and turn it so as to reverse the rectifier tube connections to the line. The use of a polarized line and line plug prevents this trouble.

If an AC line is used, this power supply will operate no matter how the line plug is connected to the line. However, one side of the AC line is usually grounded and one side is "hot." If the rectifier is plugged in so that the cathode is connected to the "hot" side of the line through the load, there will be more AC hum in the circuit attached to the power supply. Whenever you notice excessive hum in equipment using a power supply of this type, try reversing the line plug. The use of a polarized line and line plug will prevent this trouble.

# OTHER TYPES OF POWER SUPPLY CIRCUITS

## Transformerless Power Supplies (continued)

### The Voltage Doubler Power Supply

A transformerless type of power supply which is sometimes used in electronic equipment is the voltage doubler. The disadvantage of the AC-DC half-wave power supply is that it will furnish only about 100 volts B+ which places great restrictions upon the type of circuits which may use this power supply. Voltage doublers do away with this problem by supplying approximately 300 volts B+ when connected to a 110-volt AC line.

**THE VOLTAGE DOUBLER**

D C OUTPUT  
= TWICE  
PEAK A C  
INPUT

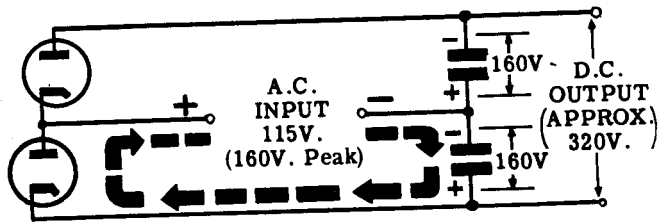
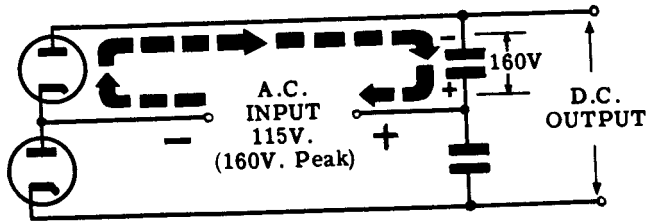

The operation of a voltage doubler circuit is very simple and is shown in the illustration. This circuit uses a rectifier containing two plates and two cathodes—giving you two half-wave rectifier circuits. Each of the two half-wave rectifiers operates off the same AC input. When the right-hand AC input terminal is positive, the upper rectifier in the diagram conducts electron current and the upper condenser charges up to peak line voltage. When the left-hand AC input terminal is positive, the lower rectifier in the diagram conducts electron current and the lower condenser charges up to peak line voltage. Each condenser is now charged and both are in series with respect to the DC output terminals. The sum of these two peak voltages is now available as a DC output which is equal to twice the peak voltage of the AC input.

In circuits of this type the heaters of the rectifier tube and the other tubes in the circuit are all connected in series in the same way as with the AC-DC half-wave rectifier. The voltage doubler will operate only when connected to an AC line since the doubling effect is due to the reversal in line voltage. The voltage doubler circuit sometimes has a transformer between the line and the AC input terminals of the doubler circuit. The transformer is used either to isolate the circuit from the ground of the AC line or to put a higher AC voltage into the circuit so as to get a very high voltage DC output.

## OTHER TYPES OF POWER SUPPLY CIRCUITS

### Transformerless Power Supplies (continued)

#### Dry Metal Rectifier Power Supplies

Earlier you learned how dry metal rectifier circuits worked. Dry metal rectifiers allow you to eliminate the transformer in an electronic power supply. Dry metal rectifiers have the advantage of being rugged, long-lived, small in size and capable of large current output. They are quite adaptable to being hooked up in half-wave, full-wave and voltage doubler circuits. They also can be hooked up to give either a positive or negative voltage output.

Dry metal rectifiers are used to some extent in radar, sonar and communications equipment. In addition they are also used as the rectifier in AC voltmeters. A few common circuits that contain dry metal rectifiers are shown below. Since you are already acquainted with both the dry metal rectifier and the circuits themselves, you should be able to understand how these circuits work without further explanation.

When power is first applied, a high current will flow to charge the input condenser. You will notice that a resistor (R) is inserted in series with each half-wave rectifier element. This resistor is put in as a current limiting device to prevent too much current from flowing through the rectifier.

**BRIDGE TYPE  
RECTIFIER**

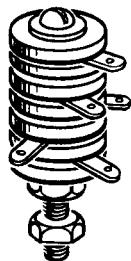

**HALF-WAVE DRY METAL RECTIFIER CIRCUIT**

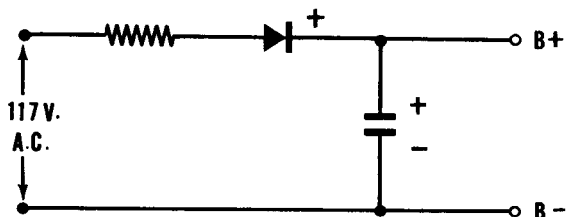

**VOLTAGE DOUBLER CIRCUIT**

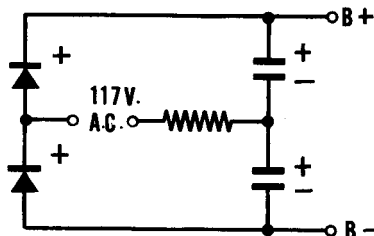

**BRIDGE RECTIFIER**

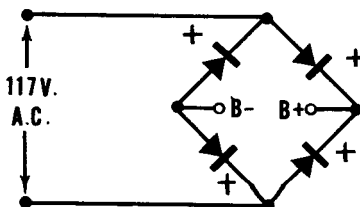

## OTHER TYPES OF POWER SUPPLY CIRCUITS

### Transformerless and Chokeless Power Supplies

Eliminating the choke as well as the transformer from the power supply results in the savings of weight, space and cost. The choke may be eliminated from the filter circuit by replacing it with a resistor. The result is a resistance-capacitor (RC) filter as shown in the illustration. RC filters are economical and work very well whenever the load current drawn from the filter circuit is small. RC filters are used extensively in oscilloscopes, vacuum tube voltmeters and other equipment that require very little B+ current drain.

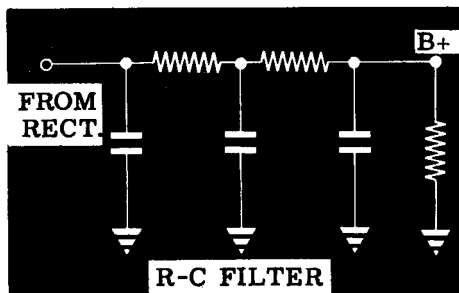
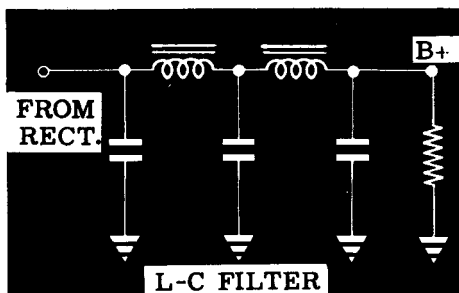

#### PARTS USED:

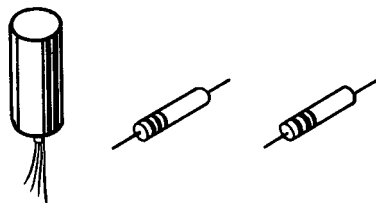
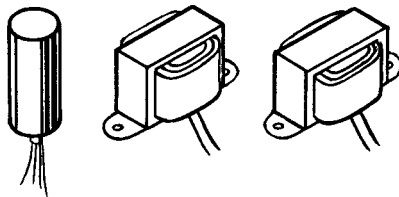

The advantage of the RC filter is its savings in weight, space and cost. The disadvantage is that the filtering action is effective only with small B+ current drain. As you recall, a choke presents a high impedance to the AC ripple coming out of the rectifier and the condenser presents a low impedance. As a result, most of the ripple will appear across the choke and very little will appear across the condenser and the load. The DC voltage, however, is not presented with any impedance by the choke other than the resistance of the winding which is very low.

The RC filter offers the same resistance to both the AC ripple and the DC current. As a result there is a drop in DC voltage caused by the DC current flow through the filter resistor. If the value of the resistor is made low to decrease the DC voltage drop, ripple voltage will get through the filter. If the value of the resistance is increased to stop the AC ripple, the drop in DC voltage will be too great. The only way to make this type of filter operate efficiently is to use a large value of resistance to draw very little DC current from B+. Very little DC current flowing through the high value of resistance means that there will be a very small DC voltage drop across the resistor and the filter will operate efficiently.



# OTHER TYPES OF POWER SUPPLY CIRCUITS

## Power Supplies for DC Voltage Sources

Now that you know something about power supplies that are specially designed to save weight and space (and cost in commercial applications), you are ready to find out something about power supplies that are designed to operate electronic equipment when only DC voltage is available.

In order to operate electronic equipment properly, a fairly high DC voltage is required for the various vacuum tubes in the equipment. When an AC line is available, it is a simple matter to step up the available AC voltage by means of a transformer and rectify the resulting high voltage AC into high voltage DC. You have seen that when space and weight restrictions are important, power supplies may eliminate the transformer and put out a DC voltage of approximately 100 volts B+. You have also seen low-voltage doubler circuits can give you a B+ voltage twice the peak value of the AC line without the use of a transformer.

You are now ready to find out how high voltage DC can be supplied to electronic circuits when the only source of voltage is DC at 110 volts or lower voltage sources such as batteries. The general solution to this problem is to change the DC to AC, which can then be stepped up in voltage and then rectified into high voltage DC. This is done by means of vibrators, motor generators, dynamotors and rotary converters. When DC voltage at approximately 110 volts is available and if a B+ voltage output of 100 volts is satisfactory, the AC-DC half-wave rectifier power supply already described may be used.

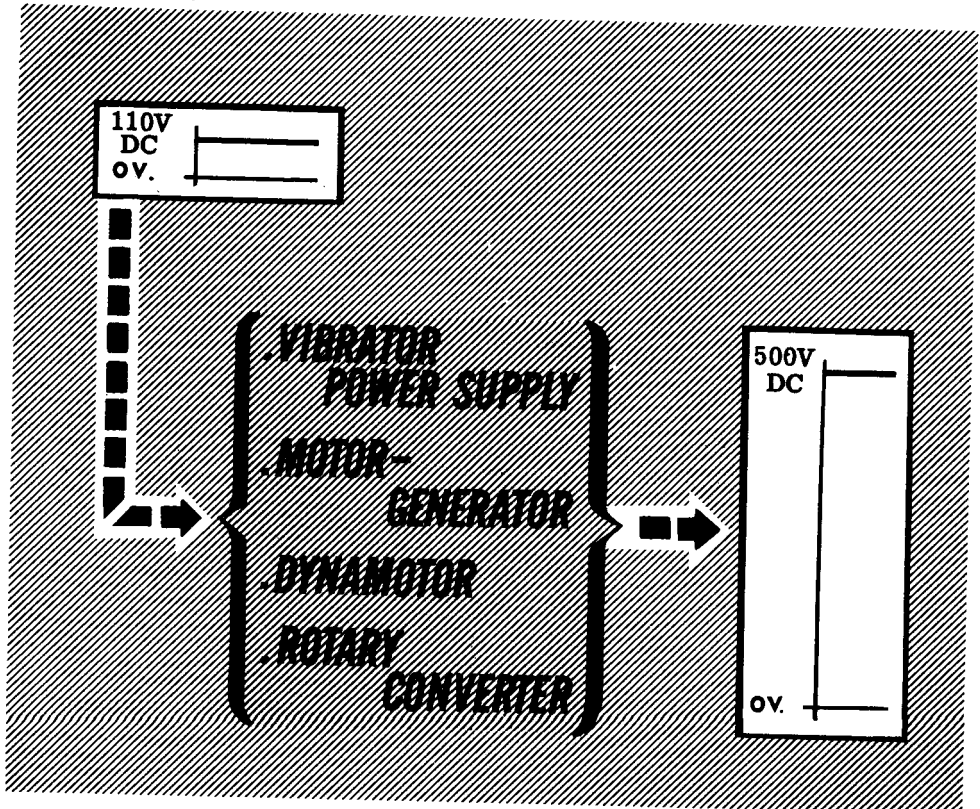

## OTHER TYPES OF POWER SUPPLY CIRCUITS

### Vibrators

The vibrator type power supply changes low voltage DC from batteries or a DC line into high voltage DC by means of three operations:

1. The low voltage DC is changed into AC of the same voltage.
2. The low voltage AC is put into a transformer and comes out as high voltage AC.
3. The high voltage AC is rectified and filtered into high voltage DC.

The vibrator is the means by which the first operation is accomplished. Operation 2 is accomplished by means of a transformer. Operation 3 is done by means of either the vibrator or one of the conventional vacuum tube rectifier and filter circuits with which you are already familiar.

The construction of a simple vibrator is shown below. A heavy strip of metal serves as a frame to hold a small electromagnet, a spring metal "reed" and two electrical contacts in place. A soft-iron tip is mounted on the free end of the reed, near the electromagnet. The electromagnet is mounted slightly off-center so that it can move the reed whenever current flows in the coil of the electromagnet. This vibrator mechanism is inserted in a metal cover which is often lined with a vibration absorbing material such as soft rubber.

### What goes on inside the VIBRATOR !

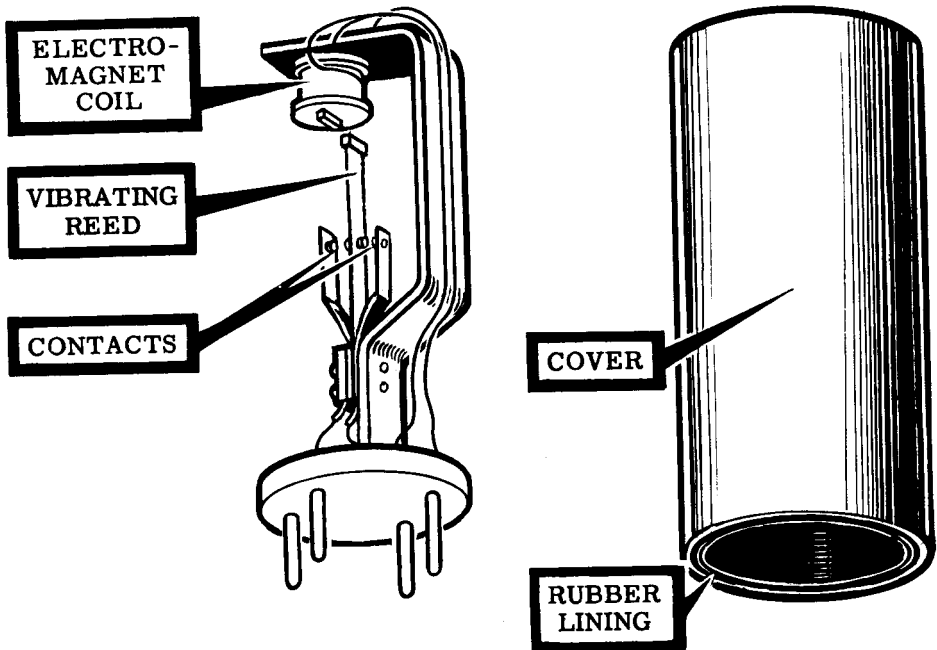

## OTHER TYPES OF POWER SUPPLY CIRCUITS

### Vibrators (continued)

The vibrator you saw on the last sheet is connected to the primary winding of a transformer as shown in the illustrations on this sheet. For the moment ignore the transformer secondary circuit and just consider what takes place in the primary circuit. Before the DC source—here shown as a battery—is connected into the circuit, the reed remains between the two contacts. When the battery is put into the circuit, the following things happen:

1. A small DC current flows from the battery through the electromagnet, through the lower half of the transformer primary and back into the battery.
2. The electromagnet builds up a magnetic field and attracts the reed towards the lower contact.
3. The reed strikes the lower contact and a large DC electron current flows from the battery through the reed, through the lower contact, through the lower half of the transformer primary and back into the battery.

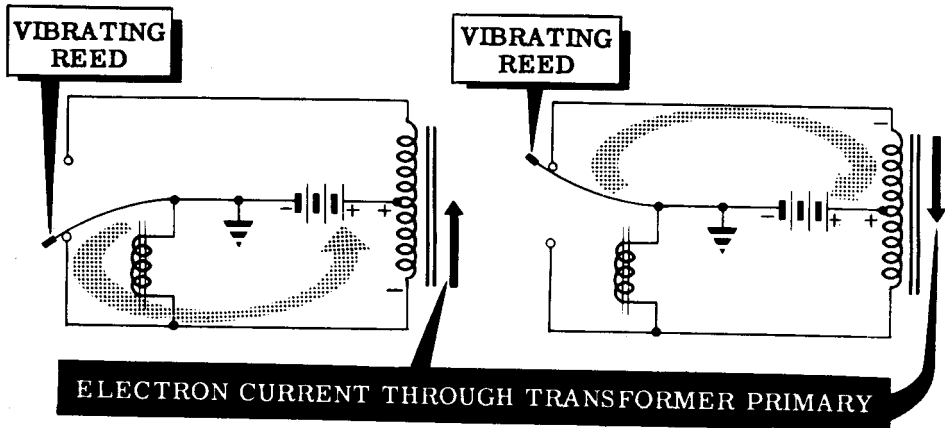

When the vibrator reed hits the lower contact, it puts a direct short across the electromagnet coil. This causes the magnetic field to collapse. Since the electromagnet can no longer hold the reed against the lower contact, the reed springs back past the center position and strikes the upper contact. When the reed strikes the upper contact, the following things happen.

4. A large DC electron current flows from the battery through the reed, through the upper contact, through the upper half of the transformer primary and back into the battery.
5. Since the electromagnet is no longer shorted out by the reed, it builds up a magnet field and pulls the reed back towards the lower contact.

The entire cycle is repeated again and again. Vibrations take place at approximately 100 times per second.

## OTHER TYPES OF POWER SUPPLY CIRCUITS

### Vibrators (continued)

The net result is an AC current that flows through the primary of the transformer, first in one direction and then in the opposite direction. This reversal of current, induces high voltage in the transformer secondary. This high voltage is rectified by a vacuum tube rectifier circuit and becomes high voltage DC. The fact that this high voltage DC has square topped peaks instead of the usual sine wave shape does not matter—the filter circuit changes it into a smooth B+ voltage.

The type of vibrator used in this circuit is known as a "non-synchronous" vibrator.

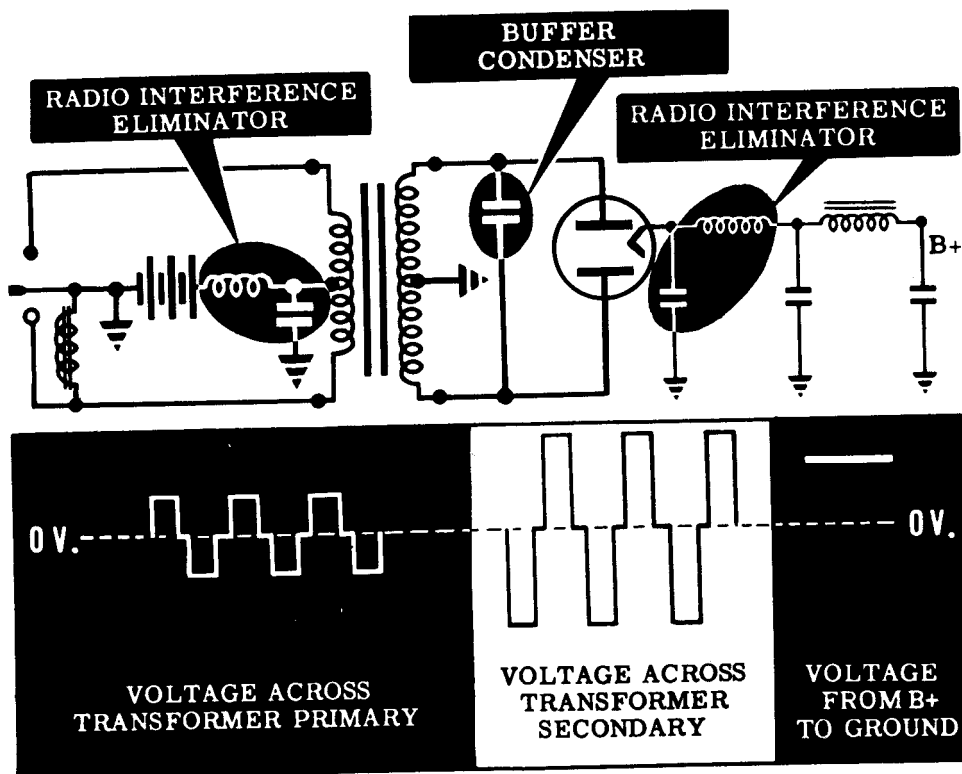

Because of the very sharp voltage surges occurring in the vibrator power supply circuit, various difficulties are experienced with this type of circuit. One annoying trouble is sparking at the vibrator contacts due to the very high voltage induced in the secondary at the instant the reed separates from the contacts. This sparking shortens the life of the vibrator, but it may be eliminated to a large extent by inserting a buffer condenser across the secondary to short out the sharp voltage pulses. This condenser has a fairly critical value, usually in the range of from 0.0005 to 0.05 microfarads. The buffer condenser reduces sparking so that the life of the vibrator contacts will not be shortened; however, any remaining sparking may cause radio interference. This radio interference is eliminated by the addition of RF chokes and condensers in the transformer primary center tap and in the rectifier output.

Vibrators (continued)

Another type of vibrator circuit is one that makes use of the vibrating reed to rectify the high voltage AC from the transformer secondary into pulsating DC without the use of a separate rectifier. This circuit is known as the "synchronous" vibrator circuit. The portion of the circuit in the transformer primary works exactly the same as in the non-synchronous vibrator circuit. The transformer secondary is connected back to the vibrator reed by means of an extra pair of contacts as shown in the diagram.

THE Synchronous Vibrator

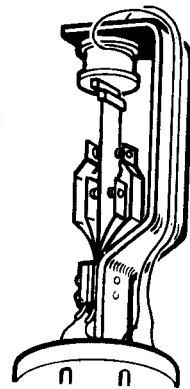
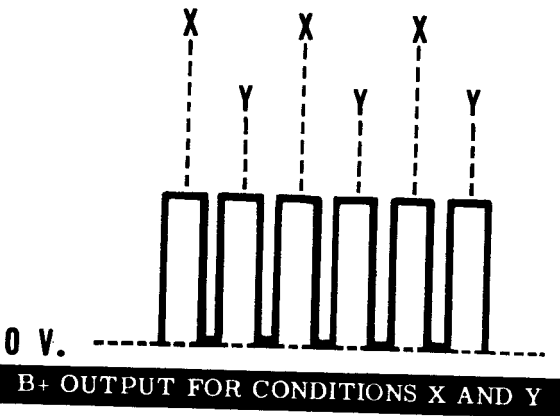
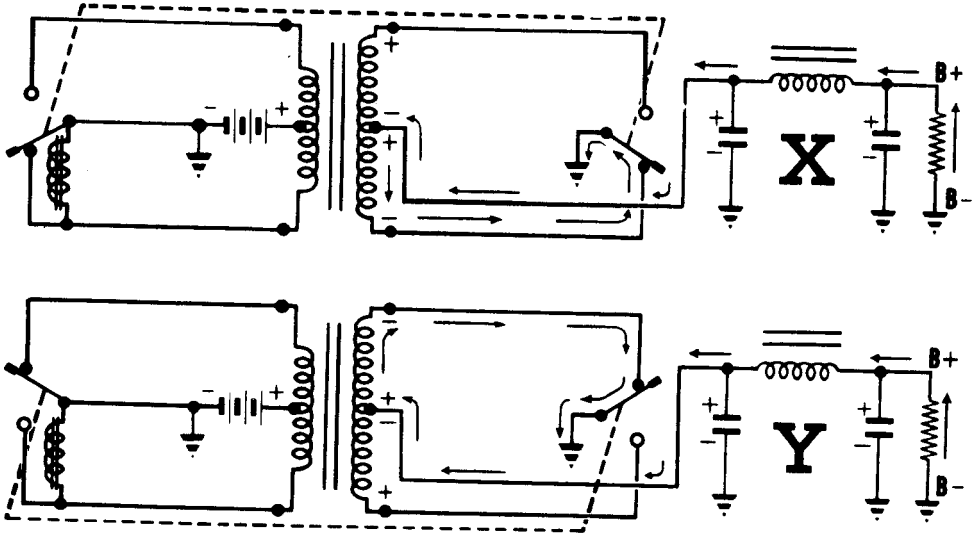

The two vibrating reeds shown connected together by the dotted line in the diagram are actually one reed placed between two pairs of contacts. The action of the reed between the transformer secondary contacts produces the same results as a full-wave rectifier. RF chokes and buffer condensers are used in this vibrator circuit in the same manner as in the non-synchronous vibrator to eliminate contact sparking and radio interference.

## OTHER TYPES OF POWER SUPPLY CIRCUITS

### Motor Generators, Dynamotors and Rotary Converters

Motor generators, dynamotors and rotary converters are sometimes used to operate AC electronic equipment when only a DC source of voltage is available. A motor generator consists of a motor and a generator mechanically connected together. For the application being considered a DC motor would be used to drive an AC generator which would be designed to give a 60-cycle output at line voltage. Equipment designed to operate from 60-cycle AC at line voltage could then be operated from a DC source by means of this type of motor generator. This type of motor generator could be used as an emergency unit by having the equipment operate off the AC line under normal conditions, and the equipment could operate from a battery source by means of the motor generator in the event of an AC line failure.

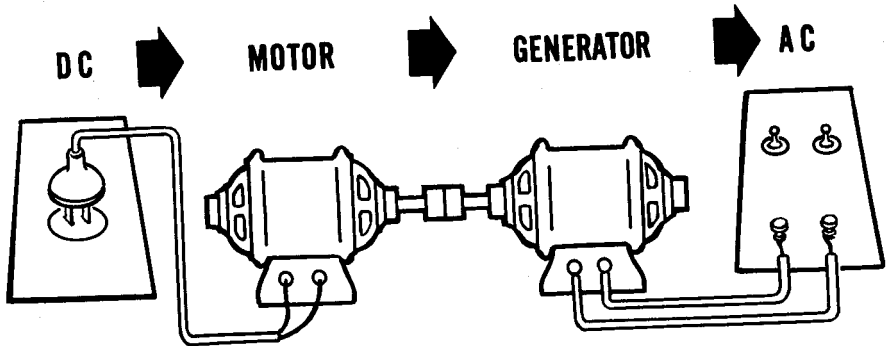

A dynamotor is a rotating DC machine that operates from a low voltage DC source and puts out one or several high voltage DC outputs. It is basically a DC motor and a DC generator built onto one armature and having two or more windings and two or more commutators. Dynamotors are usually operated from 6-, 12-, 24- or 32-volt storage batteries and deliver from 250 to over a thousand volts DC at various current ratings.

### DYNAMOTOR PRINCIPLE

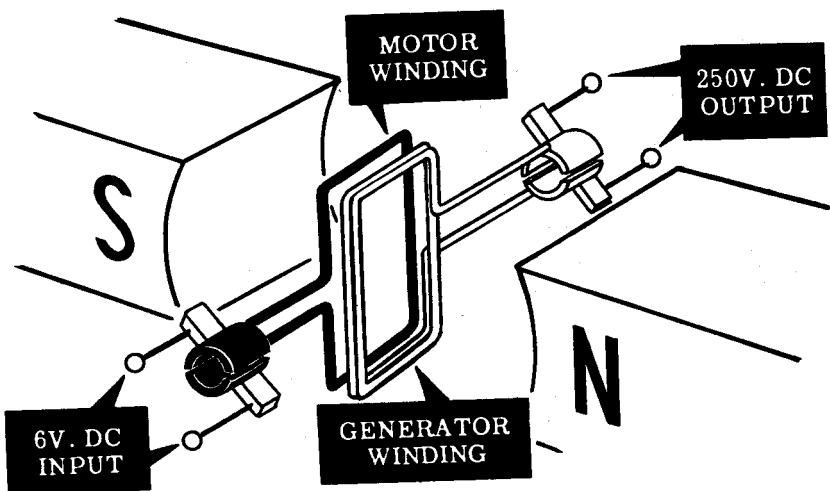

## OTHER TYPES OF POWER SUPPLY CIRCUITS

### Motor Generators, Dynamotors and Rotary Converters (continued)

Rotary converters are commonly used to change AC to DC, but they may be used to operate off storage batteries and give an output of 60 cycles AC at line voltage. When used to operate from DC sources and give AC outputs, they are known as inverters. The construction of a rotary converter is similar to a DC generator except that two slip rings are used which are connected to commutator segments 180 degrees apart.

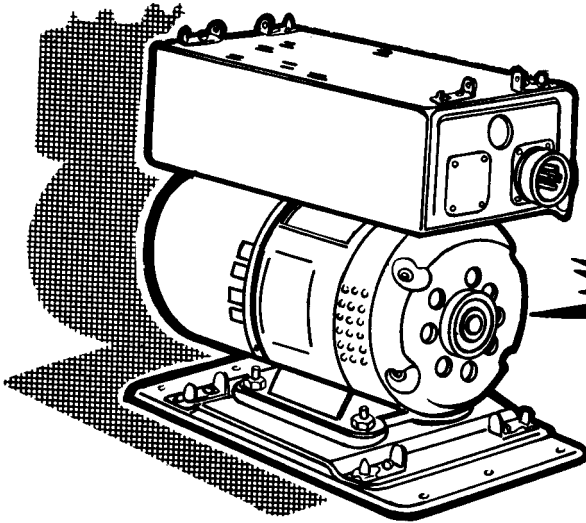
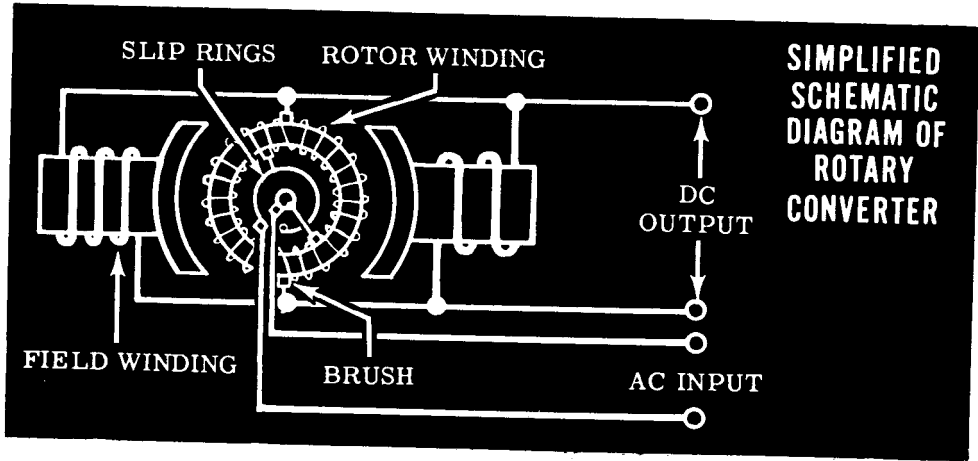

TYPICAL  
INVERTER UNIT

When the peak AC voltage output desired is no higher than the average DC voltage input, one winding may be used on the armature. If a greater voltage is desired, two windings are used on the same armature. The use of one armature and one field for both the AC and DC sections results in instability of operation. In order to increase stability the AC and DC sections are often wound on two armatures using separate fields. The two armatures are coupled together and the whole unit functions as a motor and a generator built into one unit.

# OTHER TYPES OF POWER SUPPLY CIRCUITS

## Review of Transformerless Power Supplies

### AC-DC HALF-WAVE RECTIFIER

**POWER SUPPLY** — This circuit will supply about 100 volts B+ and will operate from either in AC or DC power line. The circuit is a simple half-wave rectifier circuit usually followed by a condenser input filter. The filaments of the rectifier tube and the other tubes in the circuit are all connected in series across the power line.

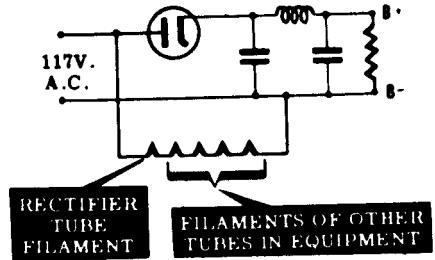

### VOLTAGE DOUBLER POWER SUPPLY

-- This circuit will supply up to 320 volts B+ from a 117-volt AC power line without the use of a transformer. The circuit consists of two half-wave rectifiers and two capacitors. The capacitors are connected in series and each is charged up to peak line voltage resulting in the voltage doubling effect. The filaments of the rectifier tube and the other tubes in the circuit are all connected in series across the power line.

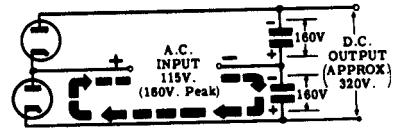

### DRY METAL RECTIFIER POWER

**SUPPLY** — Dry metal rectifiers may be used instead of vacuum tube rectifiers. Dry metal rectifiers are rugged, long-lived, small in size and capable of large current output. They can be hooked up in half-wave, full-wave and voltage doubler circuits.

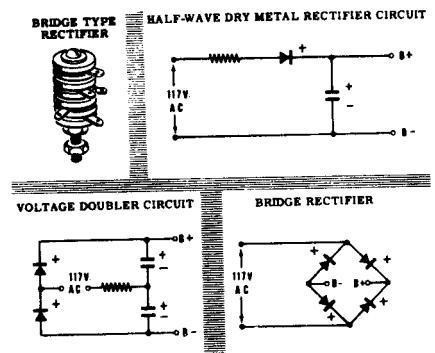



# OTHER TYPES OF POWER SUPPLY CIRCUITS

## Review of Transformerless and Chokeless Power Supplies

**CHOKeless POWER SUPPLIES** — Any of the transformerless rectifier circuits listed on the previous sheet may be used with standard choke and capacitor filter circuits. However, an additional savings may be made in space, weight and cost if the filter choke is replaced with a resistor. This type of RC filter is effective only when a very small B+ current drain is required and a fairly large resistor can be used.

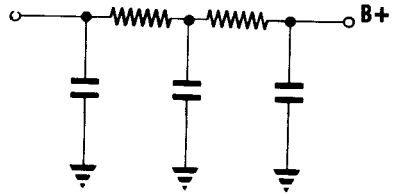

## Review of Power Supplies for DC Voltage Sources

**VIBRATORS** — A vibrator is a mechanical device which changes DC into AC. A simple vibrator is essentially a single pole double throw switch with a vibrating switch arm. When the vibrator is connected to a transformer with a center tapped primary as shown, the action of the vibrating switch arm causes current to flow first in one direction and then in the other direction through the transformer primary. The transformer puts out an alternating high voltage which can be rectified and filtered into a high voltage DC.

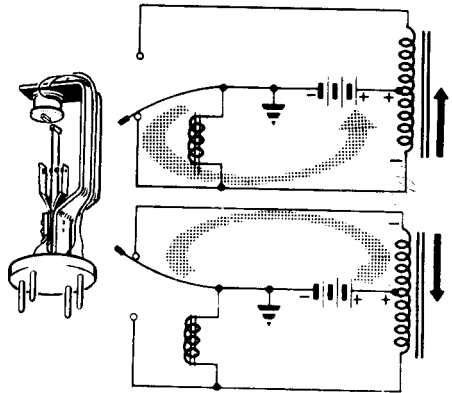

**SYNCHRONOUS VIBRATORS** — The non-synchronous vibrator changes DC into high voltage AC which must then be rectified by means of a vacuum tube rectifier. A synchronous vibrator does away with the need for a separate rectifier. The portion of the vibrator in the transformer primary works exactly as in the non-synchronous vibrator circuit. The transformer secondary is connected back to the vibrator reed by means of an extra pair of contacts as shown. The action of the vibrating reed between the transformer secondary contacts produces results the same as if a full-wave rectifier were placed there.

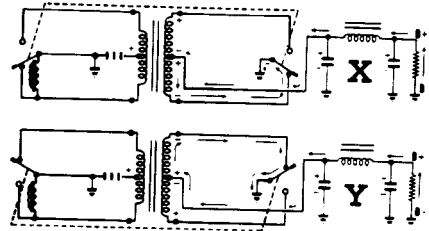

## OTHER TYPES OF POWER SUPPLY CIRCUITS

### Review of Power Supplies for DC Voltage Sources (continued)

**MOTOR GENERATOR** — A motor and a generator mechanically coupled together. Equipment designed to operate from an AC power source may be made to operate from the DC line if a motor generator is used. The DC motor is connected to the DC line, and the DC motor spins the rotor of the AC generator which puts out 117 volts AC.

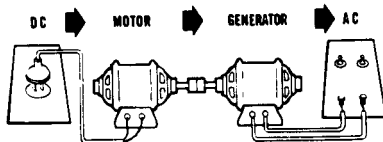

**DYNAMOTOR** — A rotating DC machine that operates from a low voltage DC source and puts out one or more high DC voltages. A dynamotor is basically a DC motor and a DC generator built onto one armature and having two or more commutators.

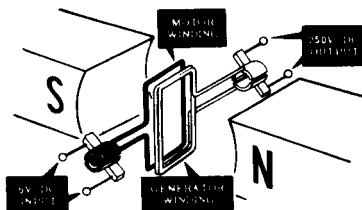

**ROTARY CONVERTER** — Rotary converters are commonly used to change AC to DC, but they may be used to operate from storage batteries to give an output of 117 volts AC and are then known as inverters. The construction of a rotary converter is similar to a DC generator except that two slip rings are used which are connected to commutator segments 180 degrees apart.

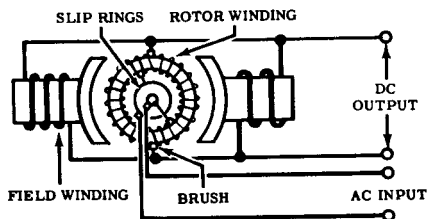

## CHARACTERISTICS OF DIODE VACUUM TUBES

### The Jobs of a Vacuum Tube

Up to this time you have been working with vacuum tubes used as rectifiers in power supply circuits. Your knowledge of diode tubes has been sufficient for an understanding of power supplies. However, from now on you are going to do a great deal of work with vacuum tubes in many types of circuits, and now is the time to begin finding out about vacuum tubes.

The subject of vacuum tubes is really a simple one because—and you will be glad to know this—vacuum tubes do only two types of jobs.

A vacuum tube can change an AC voltage into a pulsating DC voltage. This is called **RECTIFICATION**. This job is accomplished by the diode.

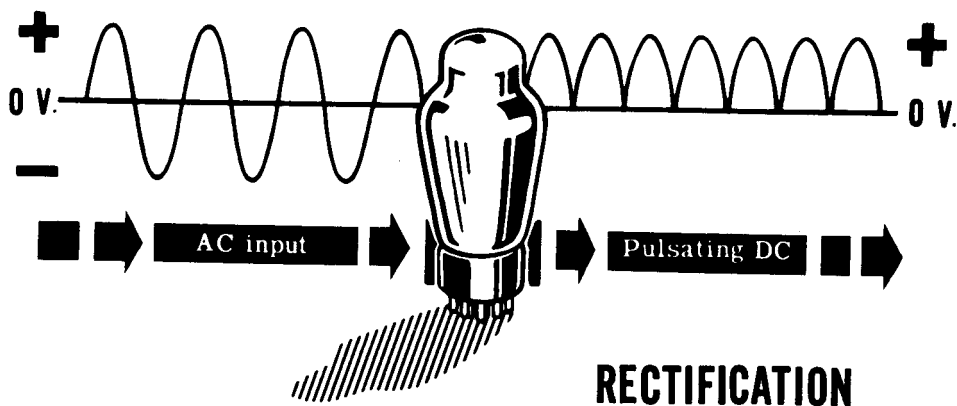

A vacuum tube can change a small AC voltage into a large AC voltage. This is called **AMPLIFICATION**. This job is done by the triode, the tetrode or the pentode.

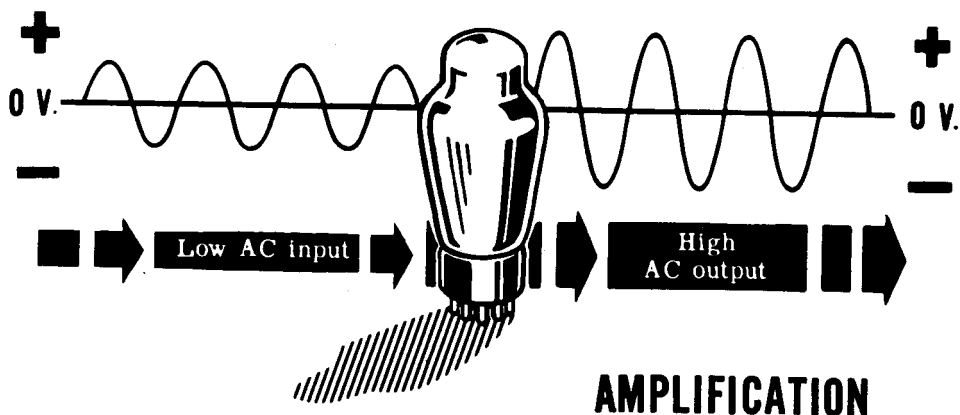

You have been concerned with the vacuum tubes that take care of rectification. Later, in the amplifier section, you will learn about the other types of vacuum tubes.

## CHARACTERISTICS OF DIODE VACUUM TUBES

### Factors Common to All Vacuum Tubes

The diode is one of the four basic types of vacuum tubes. There are many things which are common to all vacuum tubes and you won't have to learn all about these common characteristics each time you study another type of tube. You will learn about these things in your study of the diode.

As previously stated, all vacuum tubes need a source of free electrons and you will find that each type of tube obtains them in the same way as the diode—by thermionic emission. Furthermore, the cathode and filament structure does not differ very much from one type of tube to the next. You will study the effects of the filament on cathode emission only during your diode experiment—remember, it's the same for the other tubes you will study.

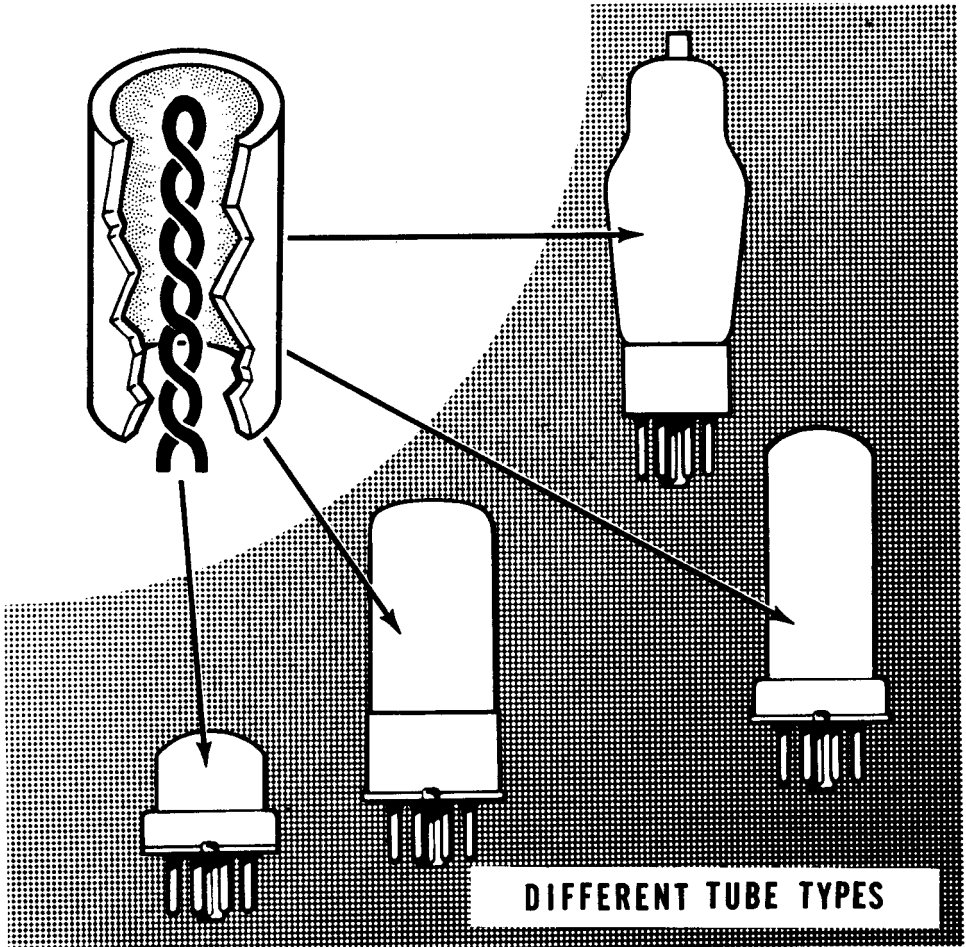

The differences between the diode and the other vacuum tubes lead to their different uses. The diode is used to change an AC voltage into a pulsating DC voltage; the other tubes are used to change a small AC voltage into a large AC voltage

# CHARACTERISTICS OF DIODE VACUUM TUBES

## Review of Diode Characteristics

Diodes are used as rectifiers in power supplies, and as detectors, noise limiters and automatic volume control tubes in radio receivers. Whatever their application is, however, diodes are used because they allow current to flow in only one direction.

From the time the plate becomes just slightly positive with respect to the cathode until the time saturation is reached, the current in the diode is proportional to the plate voltage. Between these limits, then, the tube acts the same as an ordinary resistor. Of course, when the plate voltage rises above the saturation point, the current does not respond to voltage changes and therefore, in this region, the tube loses its resemblance to the resistor.

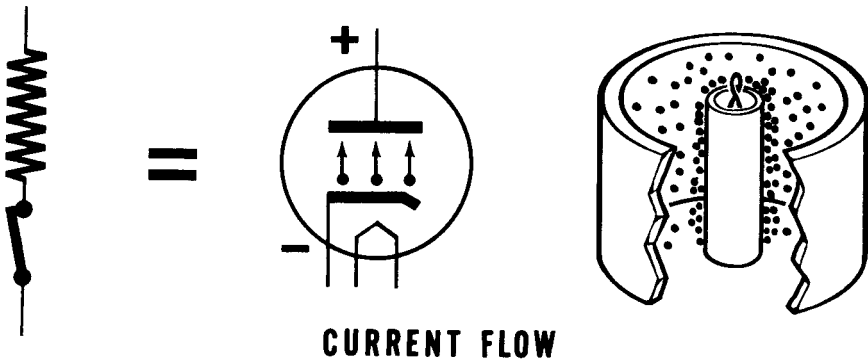

When the plate becomes the least bit negative with respect to the cathode, no electrons will flow from the cathode to the plate. The tube acts as if it were a resistor in series with a switch and the switch were opened up.

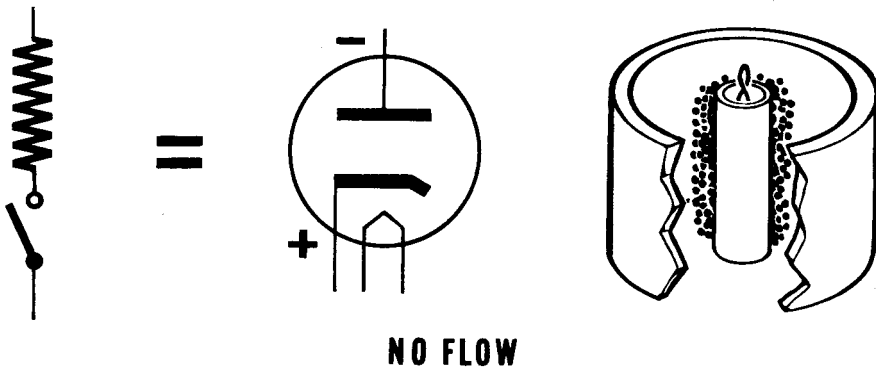

# CHARACTERISTICS OF DIODE VACUUM TUBES

## How Current Is Controlled in a Diode

A simple way to show how a diode will respond to changes of voltage is with a graph. A graph picturing how a typical diode's current is affected by its plate-to-cathode voltage (at two different values of filament voltage) is shown below.

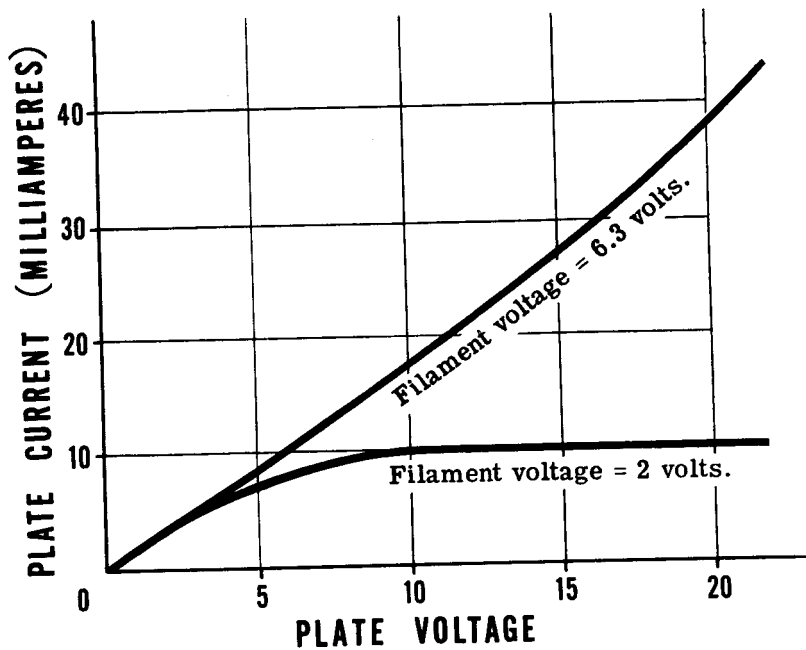

From a quick look at the graph you can tell that:

1. At normal filament voltage (6.3 volts), the plate current increases steadily as the plate voltage is increased from zero to 20 volts.
2. At the lower value of filament voltage (simulating the effect of an old tube), the plate current increases as the plate voltage is raised to about 8 volts, and any further increase of plate voltage does not bring about increased plate current. This shows us that at 8 volts the plate is drawing all the electrons the cathode can emit.

This undesirable restriction on the plate current which is due to limited cathode emission is called "saturation." Even in a fairly new tube working at rated filament voltage (6.3 volts), saturation would occur, but at a higher value of plate voltage. This would appear on the curve of 6.3 filament volts if higher values of plate voltage had been used.

# POWER SUPPLIES

## Review of Power Supplies

Before you leave the study of power supplies and go on to learn about amplifiers, suppose you review some of the important things you've found out about power supplies and their components.

**RECTIFICATION** — A diode vacuum tube allows electron current to flow in only one direction—from the cathode to the plate. This effect permits AC voltage to be "rectified" into a pulsating DC voltage.

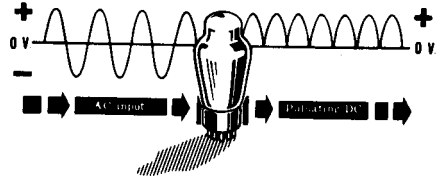

**SATURATION** — Plate current increases regularly as plate voltage is increased. When all of the electrons that can be emitted by the cathode are attracted to the plate, a further increase in plate voltage cannot attract any more electrons than are flowing already. When an increase of plate voltage fails to cause a rise in plate current, the tube is said to be "saturated."

### **SATURATION AND FILAMENT VOLTAGE**

— Increasing the filament voltage increases the filament temperature—resulting in a hotter cathode. The more heat the cathode gets, the more electrons will be emitted from its surface. When the cathode emits more electrons, the saturation point will not occur until the plate voltage reaches a much higher value.

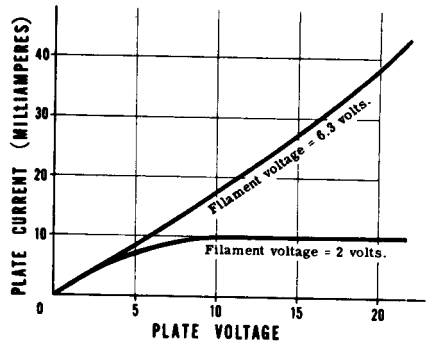

**HALF-WAVE RECTIFICATION** — Changing the positive cycles of an AC voltage to pulsating DC by allowing current to flow through a circuit in one direction only.

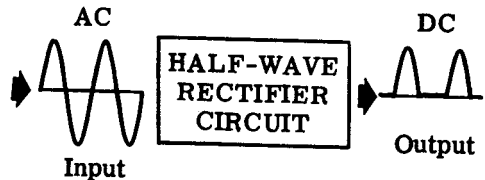

**FULL-WAVE RECTIFICATION** — Changing both cycles of AC to pulsating DC.

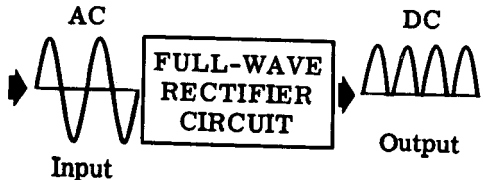

# POWER SUPPLIES

## Review of Power Supplies (continued)

**DRY METAL HALF-WAVE RECTIFIER** — A circuit which produces half-wave rectification by using a device consisting of two metallic plates which conduct current flow in only one direction.

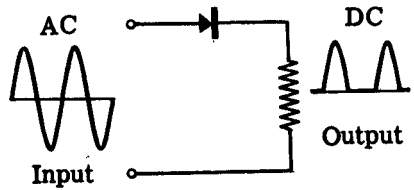

**RECTIFIER TUBE** — A vacuum tube diode consisting of plate and cathode which allow electron flow only from cathode to plate and thus acts as a rectifier.

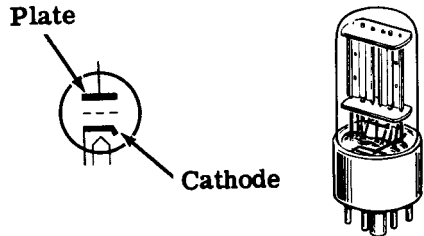

**VACUUM-TUBE RECTIFIER CIRCUIT** — A diode vacuum tube connected in series with an AC voltage source to change AC to DC.

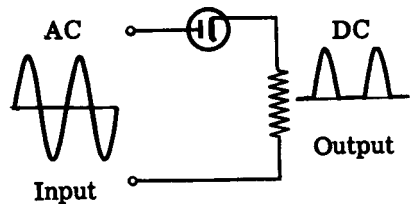

**TRANSFORMER TYPE HALF-WAVE RECTIFIER** — A circuit which uses a transformer to supply high-voltage AC to a vacuum tube rectifier, which then rectifies it to pulsating high-voltage DC.

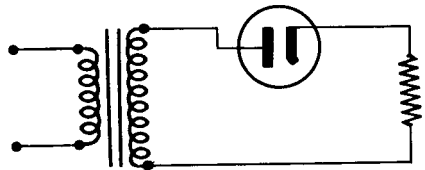

**FULL-WAVE RECTIFIER CIRCUIT** — A circuit which uses a transformer and a full-wave rectifier diode to produce full-wave rectified pulsating DC from an AC input.

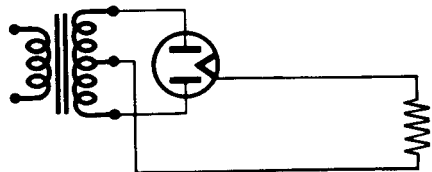



# POWER SUPPLIES

## Review of Power Supplies (continued)

**FILTER CIRCUITS** — Circuits consisting of inductors and capacitors used to change pulsating DC output of a rectifier to pure DC.

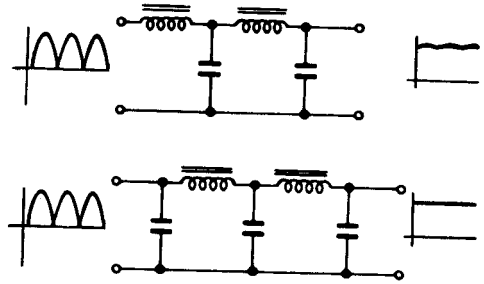

**COMPLETE POWER SUPPLY** — The complete circuit consisting of full-wave rectifier and filter circuits, used to supply high DC voltage to other circuits.

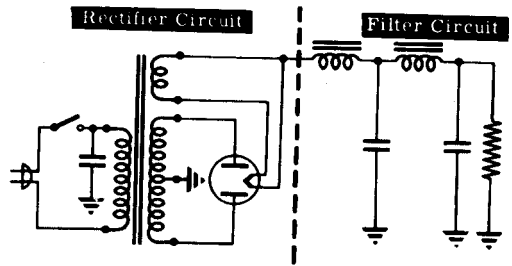

**VOLTAGE REGULATOR CIRCUIT** — A circuit which uses a gas-filled diode to maintain constant output voltage. The voltage across tube terminals remains constant over a large range of source voltage or load current changes.

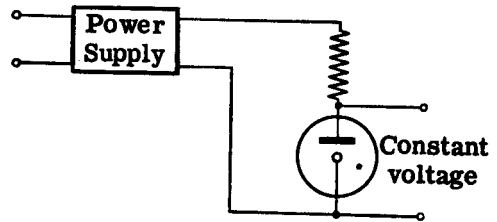

**OTHER POWER SUPPLIES** — Transformerless and chokeless power supplies, vibrators, motor-generators, dynamotors and rotary converters are other types of power supplies used to fill special requirements as to size, weight, power source available and load requirements.

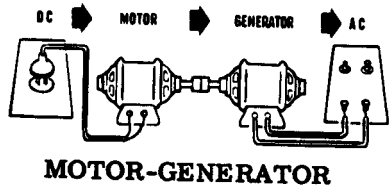
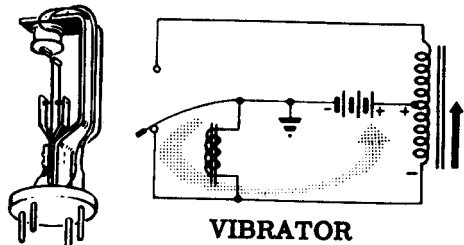



# INDEX TO VOL. 1

(Note: A cumulative index covering all five volumes in this series will be found at the end of Volume 5.)

- AC-DC half-wave rectifier, in power supplies, 1-94, 1-95
- Bridge rectifier circuits, 1-49, 1-50
- Current flow, in half-wave rectifier circuit, 1-43  
in full-wave rectifier circuit, 1-48
- Diodes, characteristics of, 1-109 to 1-112
  - current flow in, 1-28, 1-29
  - gas-filled, 1-35, 1-37
  - how current is controlled in, 1-112
  - how they work, 1-25
  - in transformer type circuits, 1-40, 1-41
  - vacuum-filled, 1-36
- Dynamotors, 1-104
- Electronics, meaning of, 1-1
- Electronic equipment, 1-2
  - parts used in, 1-3
- Filters, improving operation of, 1-64, 1-65
  - in power supplies, 1-12
- Filter capacitors (condensers), 1-60 to 1-63
  - dry electrolytic, 1-63
  - electrolytic, 1-61 to 1-63
  - paper construction of, 1-60
  - paper high voltage, 1-60
  - wet electrolytic, 1-62
- Filter chokes, 1-69
- Filter circuits, 1-52 to 1-80
  - capacitors in, 1-57 to 1-59
  - capacitor input, single-section, 1-70, 1-72
  - choke input, single-section, 1-70, 1-71
  - in power supplies, 1-53
  - parallel-resonant, 1-73
  - RC faults of, 1-66, 1-67
  - series-resonant, 1-73
  - two-section, 1-73
  - using choke instead of resistor, 1-68
- Input filter capacitor, charging, 1-74
- Inverters, 1-105
- Motor generators, 1-104
- Power line filter capacitor circuits, 1-43
- Power supplies, circuits in, 1-52
  - dry metal rectifier, 1-97
  - for DC voltage sources, 1-99
  - general types, 1-93
  - importance of, 1-7
  - need for other types, 1-92
  - transformer type, 1-39
  - transformerless, 1-94 to 1-98
  - transformerless and chokeless, 1-98
  - voltage doubler, 1-96
  - what they do, 1-8
  - why there are different types, 1-14 to 1-16
- Rectifiers, changing AC to DC
  - in half-wave
    - dry metal type, 1-17
    - circuits in dry metal half-wave type, 1-21
    - copper oxide, 1-18
    - description of half-wave dry metal type, 1-18 to 1-20
    - dry metal half-wave, 1-17 to 1-22
    - full-wave, 1-45 to 1-151
    - gas-filled diodes, 1-35 to 1-37
    - how the full-wave type works, 1-46
    - parallel connection of elements
      - in dry metal type, 1-19
    - power supplies, 1-10, 1-11

# INDEX TO VOL. 1

- selenium, 1-18, 1-20
- series stacking of elements in dry
  - metal type, 1-19
  - transformer type half-wave, 1-39 to 1-44
  - vacuum tubes, 1-23
  - vacuum tube half-wave type, 1-23 to 1-38
- Rectifier circuits, half-wave vacuum tube, 1-33
- Rectifier output, AC and DC components in, 1-55, 1-56
  - characteristics of, 1-54
  - filtering half- and full-wave, 1-74
- Rectifier tubes, 1-30, 1-31
  - cathode type, 1-31
  - diodes, 1-30, 1-31
  - directly heated, 1-32
  - full-wave, 1-47
  - indirectly heated, 1-32
  - plates connected together, 1-32
  - plates connected separately, 1-32
- Resistors, bleeder, 1-75 to 1-77
- Review, Characteristics of Diode Vacuum Tubes, 1-111
  - Filter Circuits, 1-78 to 1-80
  - Full-Wave Rectifier Circuit, 1-51
  - Half-Wave Rectifiers — Dry Metal Type, 1-22
  - Half-Wave Rectifiers—Transformer Type, 1-44
  - Half-Wave Rectifiers — Vacuum Tube Type, 1-38
  - Other Types of Power Supply Circuits, 1-106 to 1-108
  - Power Supplies, 1-113 to 1-115
  - Voltage Regulator Circuits, 1-91
- Rotary converters, 1-105
- Transformers, power supplies, 1-9
- Transformer type circuit, diagram of, 1-42
  - operation of, 1-43
- Vacuum tube, circuit wiring, 1-34
  - discovery of diode, 1-24
  - electron emission, 1-26, 1-27
  - factors common to all, 1-110
  - jobs of, 1-109
  - methods of representation in diagrams, 1-34
  - sockets, 1-31
- Vibrators, 1-100 to 1-103
  - synchronous, 1-103
- Voltage regulation, 1-81, 1-82
  - when load current varies, 1-87, 1-88
  - when power supply voltage varies, 1-89, 1-90
- Voltage regulators, power supplies, 1-13
- Voltage regulator circuits, 1-81 to 1-91
- Voltage regulator tube, 1-83, 1-84
- Voltage regulator tube circuit, 1-85, 1-86

## HOW THIS OUTSTANDING COURSE WAS DEVELOPED:

In the Spring of 1951, the Chief of Naval Personnel, seeking a streamlined, more efficient method of presenting Basic Electricity and Basic Electronics to the thousands of students in Navy speciality schools, called on the graphiological engineering firm of Van Valkenburgh, Nooger & Neville, Inc., to prepare such a course. This organization, specialists in the production of complete "packaged training programs," had broad experience serving industrial organizations requiring mass-training techniques.

These were the aims of the proposed project, which came to be known as the Common-Core program: to make Basic Electricity and Basic Electronics completely understandable to every Navy student, regardless of previous education; to enable the Navy to turn out trained technicians at a faster rate (cutting the *cost* of training as well as the time required) without sacrificing subject matter.

The firm met with electronics experts, educators, officers-in-charge of various Navy schools and, with the Chief of Naval Personnel, created a dynamic new training course . . . completely up-to-date . . . with heavy emphasis on the visual approach.

First established in selected Navy schools in April, 1953, the training course comprising Basic Electricity and Basic Electronics was such a tremendous success that it is now the *backbone* of the Navy's *current* electricity and electronics training program!\*

The course presents one fundamental topic at a time, taken up in the order of need, rendered absolutely understandable, and hammered home by the use of clear, cartoon-type illustrations. These illustrations are the most effective ever presented. *Every page has at least one such illustration—every page covers one complete idea!* An imaginary instructor stands figuratively at the reader's elbow, doing demonstrations that make it easier to understand each subject presented in the course.

Now, for the first time, Basic Electricity and Basic Electronics have been released by the Navy for civilian use. While the course was *originally* designed for the Navy, the concepts are so broad, the presentation so clear—*without* reference to specific Navy equipment—that it is ideal for use by schools, industrial training programs, or home study. *There is no finer training material!*

"Basic Electronics" consists of *five* volumes, as follows: *Vol. 1*—Introduction to Electronics, Diode Vacuum Tubes, Dry Metal Rectifiers, What a Power Supply Is, Filters, Voltage Regulators. *Vol. 2*—Introduction to Amplifiers, The Triode Tube, Tetrodes & Pentodes, Audio Voltage & Power Amplifiers. *Vol. 3*—Video Amplifiers, RF Amplifiers, Oscillators. *Vol. 4*—Transmitters, Transmission Lines & Antennas, CW Transmission & Amplitude Modulation. *Vol. 5*—Receiver Antennas, Detectors & Mixers, TRF Receivers, Superheterodyne Receivers.

\*"Basic Electricity," the first portion of this course, is available as a separate series of volumes.

**JOHN F. RIDER PUBLISHER, INC., 116 WEST 14th ST., N. Y. 11, N. Y.**



No. 170-2

# basic electronics

by **VAN VALKENBURGH,  
NOOGER & NEVILLE, INC.**

**VOL. 2**

INTRODUCTION TO AMPLIFIERS  
THE TRIODE TUBE  
TETRODES & PENTODES  
AUDIO VOLTAGE &  
POWER AMPLIFIERS

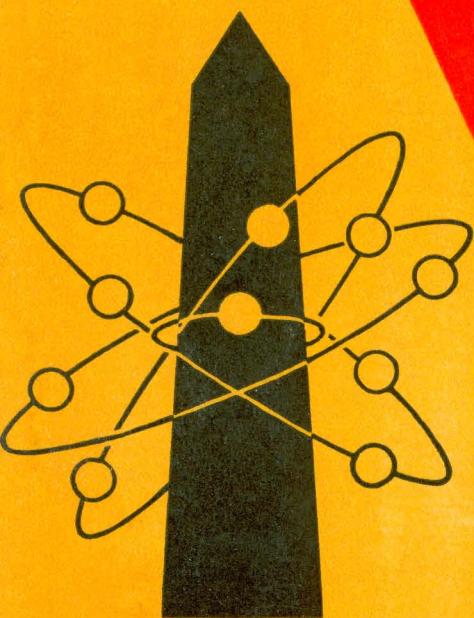

A. STICH

a **RIDER** publication

\$2.25

# **basic electronics**

**by VAN VALKENBURGH,  
NOOGER & NEVILLE, INC.**

**VOL. 2**



**JOHN F. RIDER PUBLISHER, INC.**  
116 West 14th Street • New York 11, N. Y.

**First Edition**

*Copyright 1955 by*

**VAN VALKENBURGH, NOOGER AND NEVILLE, INC.**

**All Rights Reserved under International and Pan American Conventions. This book or parts thereof may not be reproduced in any form or in any language without permission of the copyright owner.**

*Library of Congress Catalog Card No. 55-6984*

**Printed in the United States of America**



## PREFACE

The texts of the entire Basic Electricity and Basic Electronics courses, as currently taught at Navy specialty schools, have now been released by the Navy for civilian use. This educational program has been an unqualified success. Since April, 1953, when it was first installed, over 25,000 Navy trainees have benefited by this instruction and the results have been outstanding.

The unique simplification of an ordinarily complex subject, the exceptional clarity of illustrations and text, and the plan of presenting one basic concept at a time, without involving complicated mathematics, all combine in making this course a better and quicker way to teach and learn basic electricity and electronics.

In releasing this material to the general public, the Navy hopes to provide the means for creating a nation-wide pool of pre-trained technicians, upon whom the Armed Forces could call in time of national emergency, without the need for precious weeks and months of schooling.

Perhaps of greater importance is the Navy's hope that through the release of this course, a direct contribution will be made toward increasing the technical knowledge of men and women throughout the country, as a step in making and keeping America strong.

*Van Valkenburgh, Nooger and Neville, Inc.*

*New York, N. Y.*

*February, 1955*



# TABLE OF CONTENTS

## VOL. 2 — BASIC ELECTRONICS

Introduction to Amplifiers . . . . .	2-1
The Triode . . . . .	2-11
The Triode Amplifier . . . . .	2-24
The Tetrode and the Pentode . . . . .	2-42
The Single-Stage Amplifier . . . . .	2-55
The Two-Stage RC Coupled Amplifier . . . . .	2-58
The Transformer-Coupled Amplifier . . . . .	2-67
The Audio Power Amplifier . . . . .	2-71
The Output Transformer . . . . .	2-74
The Push-Pull Amplifier . . . . .	2-78
Microphones, Earphones and Loudspeakers . . . . .	2-87



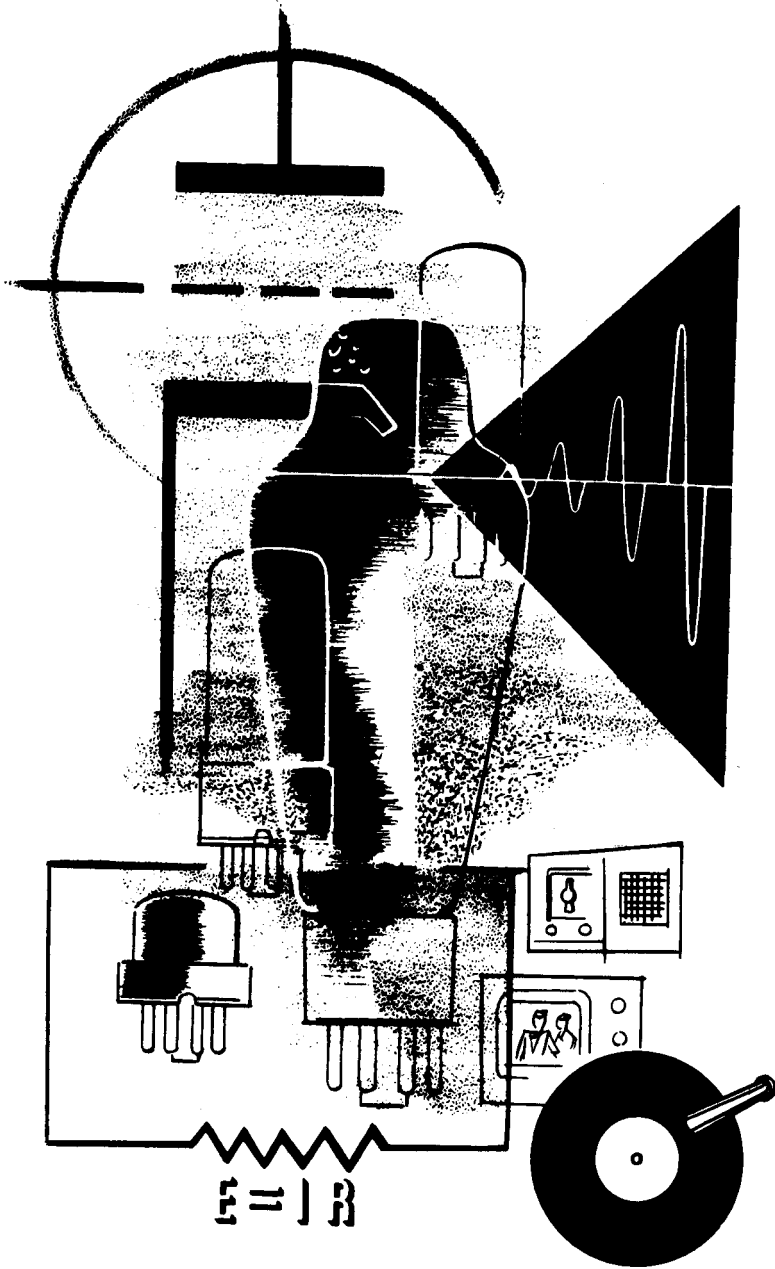

$$E = IR$$

# *Audio Amplifiers*



# INTRODUCTION TO AMPLIFIERS

## Examples of Amplification

There are many things you can amplify:



# Fact

Examples of Amplification (continued)

# Sight

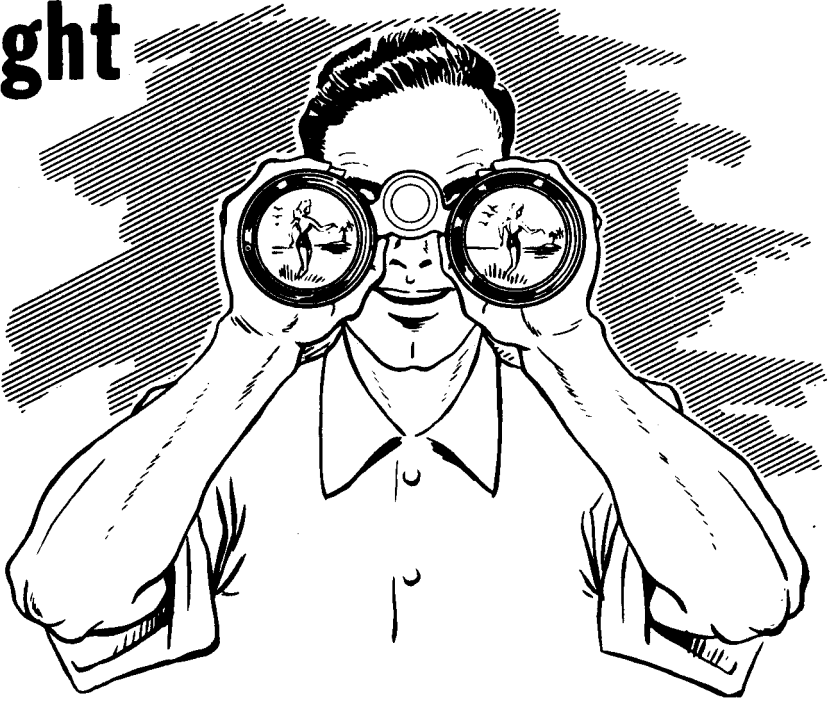

# Sound





## INTRODUCTION TO AMPLIFIERS

### Examples of Amplification (continued)

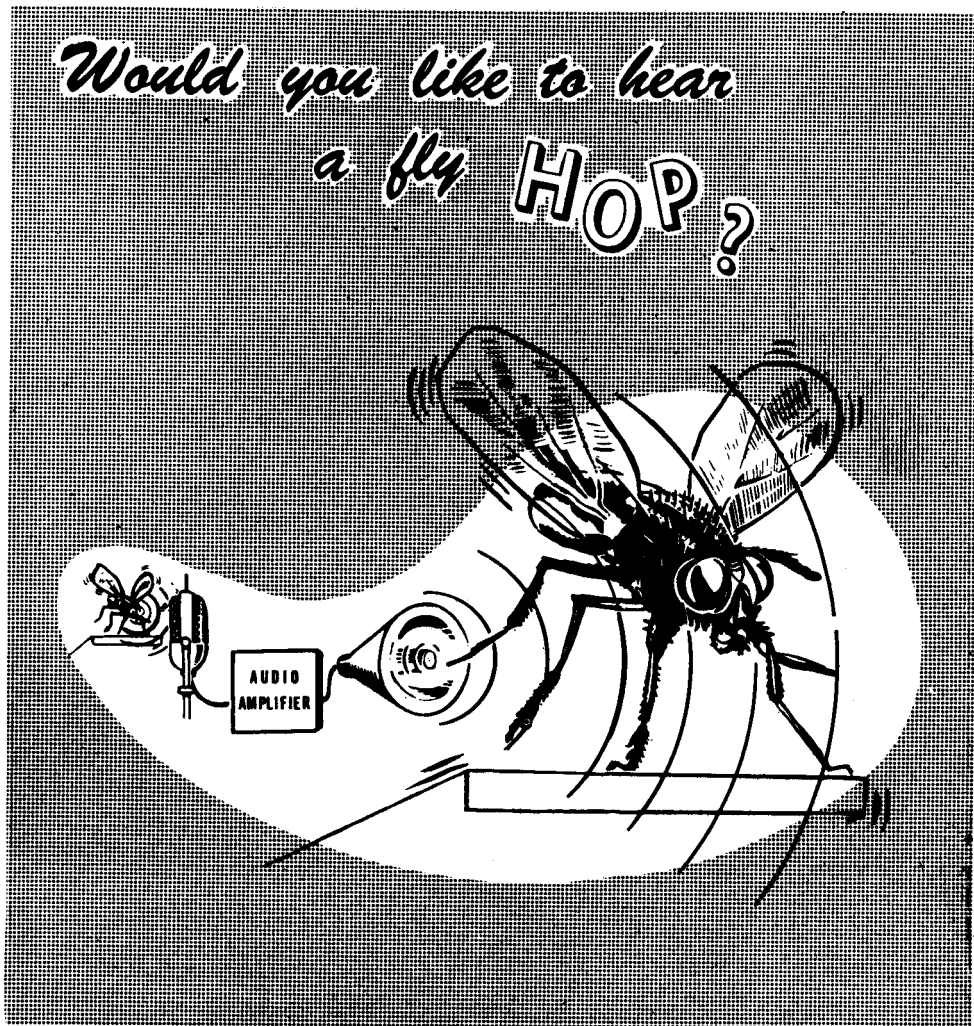

would you like to hear a whisper through a concrete wall or hear a fish pump water through its gills? Amplification makes all these things possible. There are however, more important uses for amplifiers.

Of the three basic types of electronic circuits—rectifiers, amplifiers and oscillators—amplifiers are by far the most widely used. The purpose of an amplifier is to take a very small voltage change—one that is so small that it cannot be used—and amplify it many times so that it can run a pair of earphones, drive a loudspeaker, be seen on a 'scope, operate a motor, etc.

# INTRODUCTION TO AMPLIFIERS

## What a Vacuum Tube Can Do

Make a Radio Play

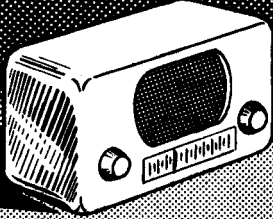

Show You Your Favorite  
Television Program

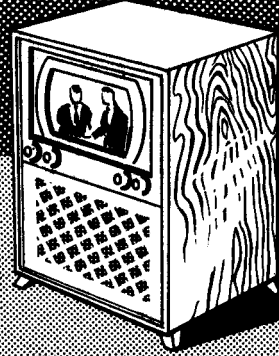

Operate A Radar System Which Seeks Out Enemy Planes

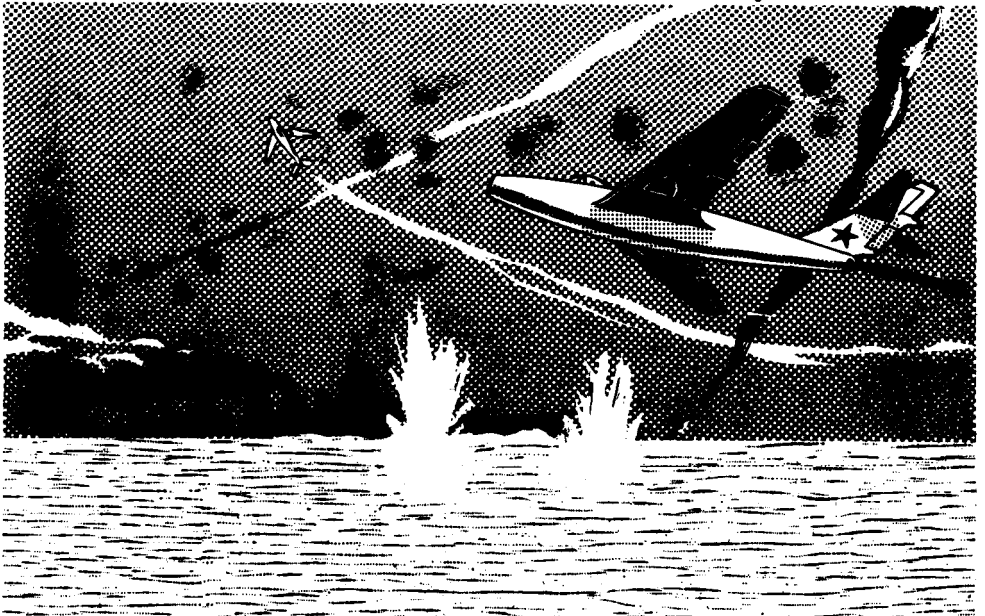

## INTRODUCTION TO AMPLIFIERS

### What a Vacuum Tube Can Do (continued)

When you first began your study of vacuum tubes you learned that there are only two main jobs for vacuum tubes to do.

The first job is to change an AC voltage into a pulsating DC voltage. This is called "rectification."

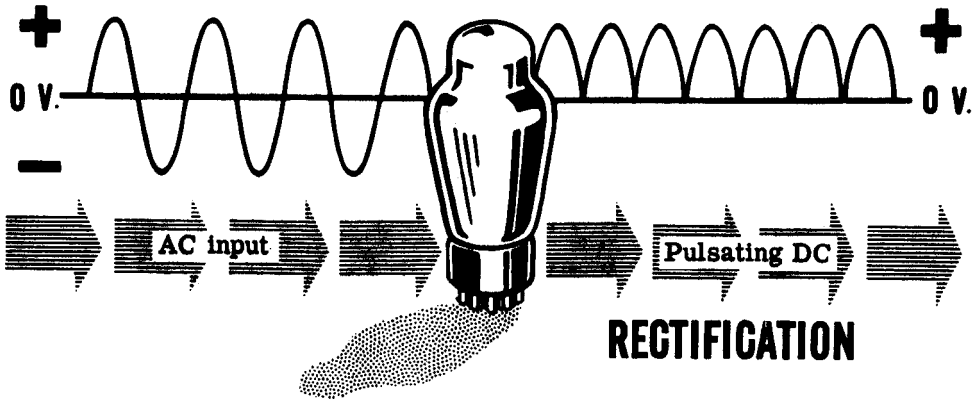

The second job is to change a small AC voltage into a large AC voltage. This is called "amplification."

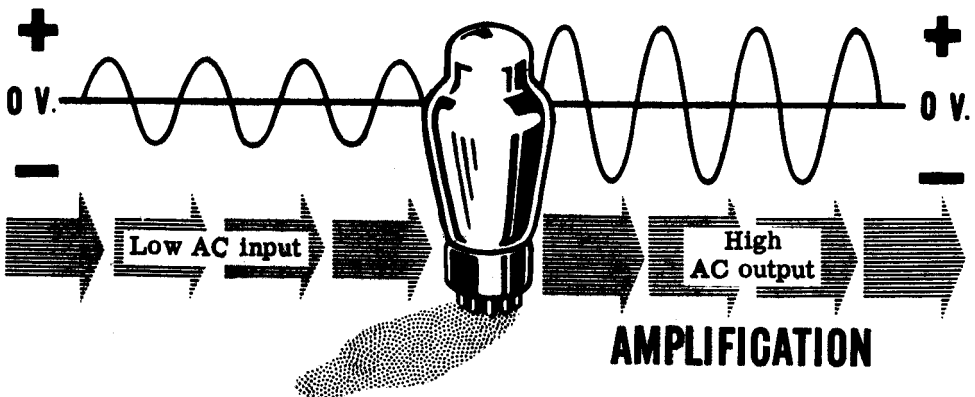

Because of your work with rectifier and power supply circuits, you now know all you need to know about rectification and the diode tubes that are used to do this job. Now you are ready to learn about the second main job a vacuum tube can do—amplification. In this section you will learn about the vacuum tubes that do the job of amplifying small AC voltages into large AC voltages.

## Types of Vacuum Tubes

A recent survey of vacuum tubes manufactured in the United States showed that there are over 1,200 different types of vacuum tubes available! These tubes come in a wide variety of shapes and sizes—enclosed in glass and metal shells.

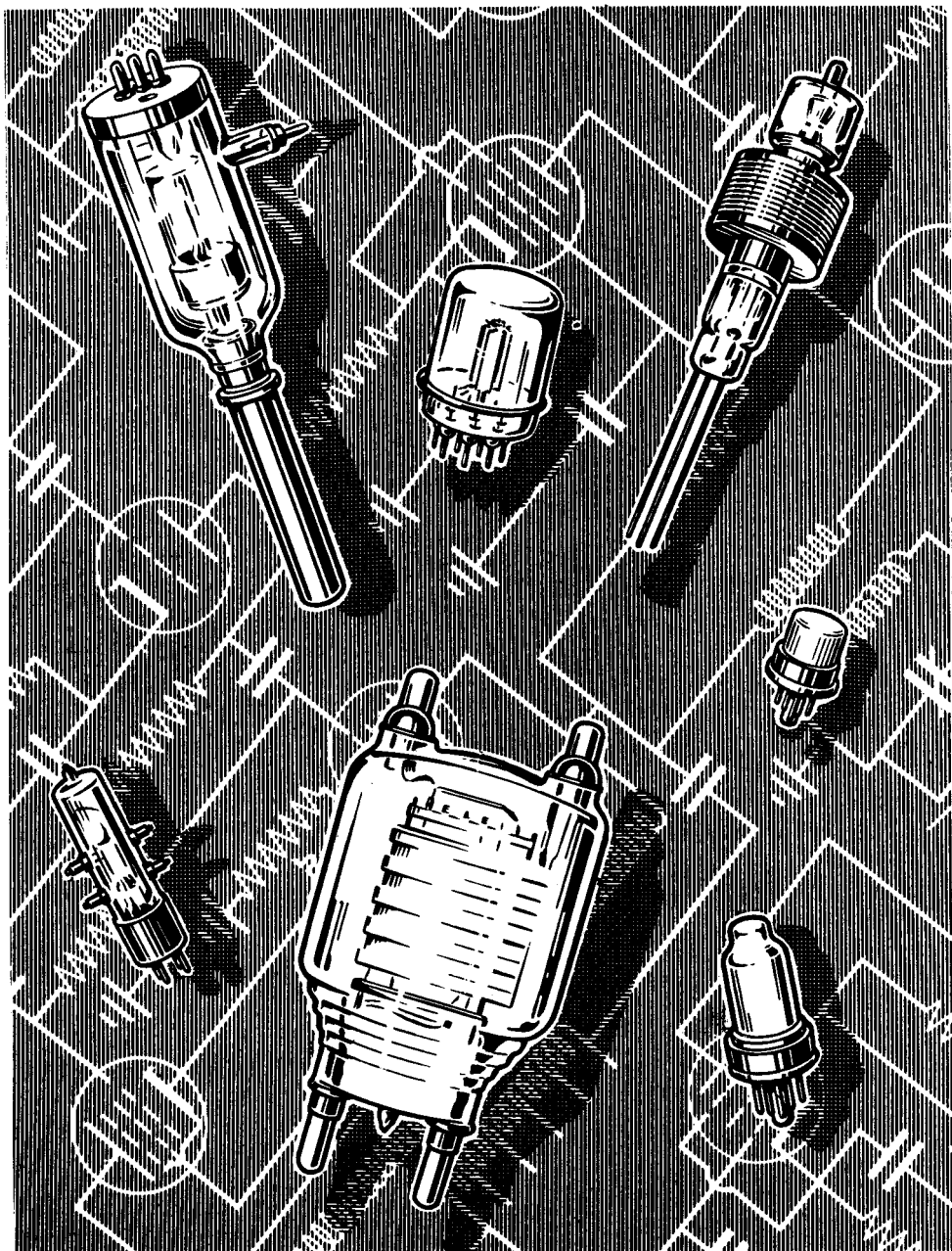

## INTRODUCTION TO AMPLIFIERS

### Types of Vacuum Tubes (continued)

Most of these 1,200 tubes can be broken down into four main types. Once you understand these four main types, you will know them all. Whenever you run across a new tube, you will always be able to understand what it does and how it works simply by comparing it to the four main types you know.

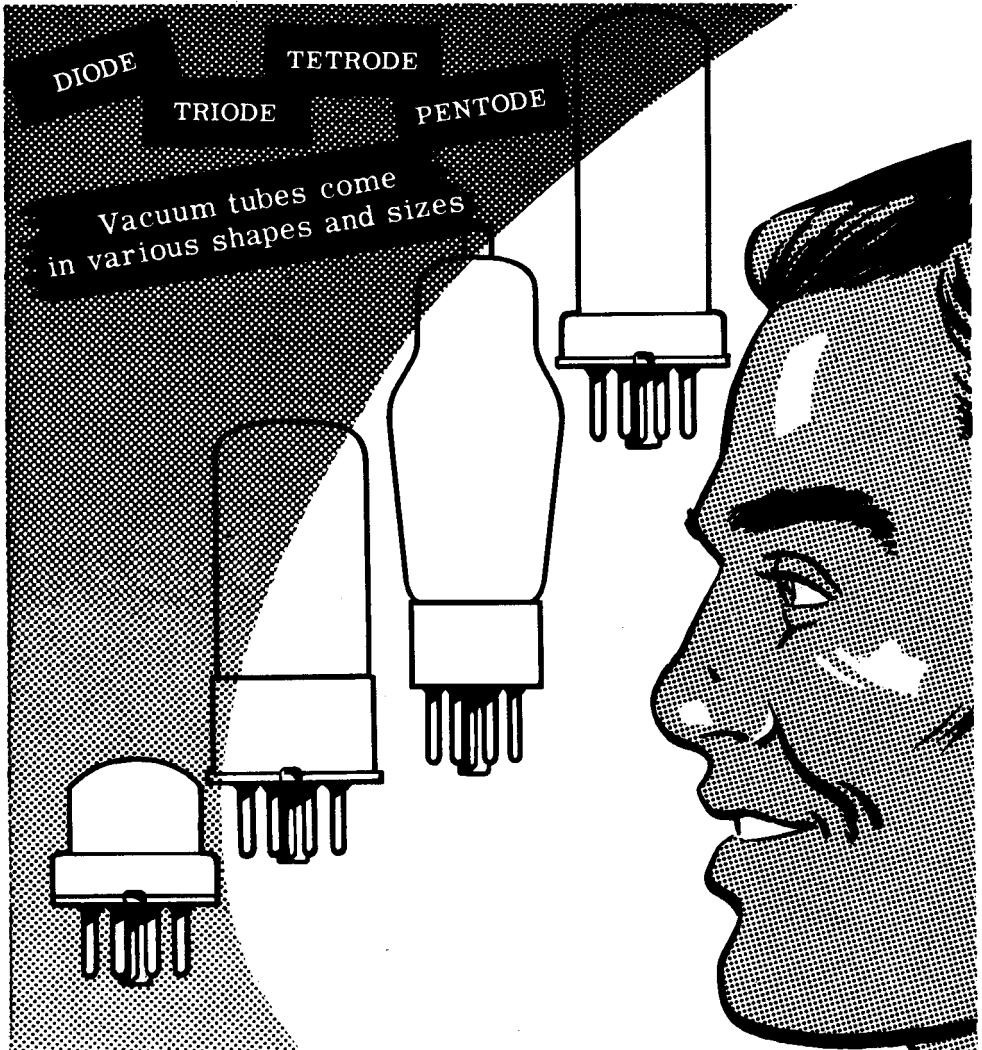

Their names describe them by telling how many parts (cathode, grid, plate) there are in the tube. A diode (di = two) has two parts—a cathode and a plate. A triode (tri = three) has three parts—a cathode, a plate and one grid. A tetrode (tetra = four) has four parts—a cathode, a plate and two grids. A pentode (penta = five) has five parts—a cathode, a plate and three grids.

How Vacuum Tubes Were Developed

# Development of Vacuum Tubes . . . .

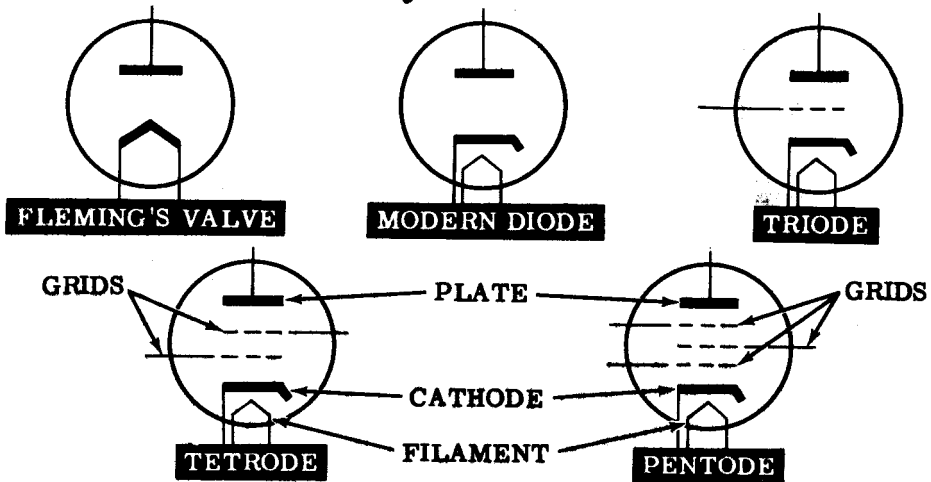

Tubes have developed in a logical sequence. . .

1. from Fleming's valve . . . . . which consists of two elements, the filament and the plate,
2. to the modern diode . . . . . in which the filament is replaced by a combination of a filament and a cathode (for reasons which will be discussed later) but which is still considered to be a two-element tube,
3. to the triode . . . . . a three-element tube which contains one grid,
4. to the tetrode . . . . . a four-element tube with two grids,
5. to the pentode . . . . . a five-element tube with three grids.

The reason you are being taught vacuum tubes is not so that you will be able to repair one which has gone bad; you will only replace such a tube with a new one. You are being taught about these vacuum tubes in order to understand the circuits which use them and, thereby, to make you a more valuable troubleshooter of electronic equipment.

You will remember from your work with power supplies that thermionic emission—the emitting of electrons by a hot cathode—allowed you to change AC into DC. Notice that triodes, tetrodes and pentodes also contain a cathode, which emits electrons, and a plate which collects electrons. As you study these tubes you will see how the grids control electron flow to change small AC voltages into large AC voltages.

## INTRODUCTION TO AMPLIFIERS

### How Vacuum Tubes Were Developed (continued)

The construction of each of these four types varies greatly—all diodes, for example, are not built the same, do not look alike and do different jobs. In addition, combinations of a diode, triode, or pentode, may be put in one tube envelope. All these combinations add up to the 1,200 vacuum tubes manufactured today.

## THE FOUR MAIN TYPES

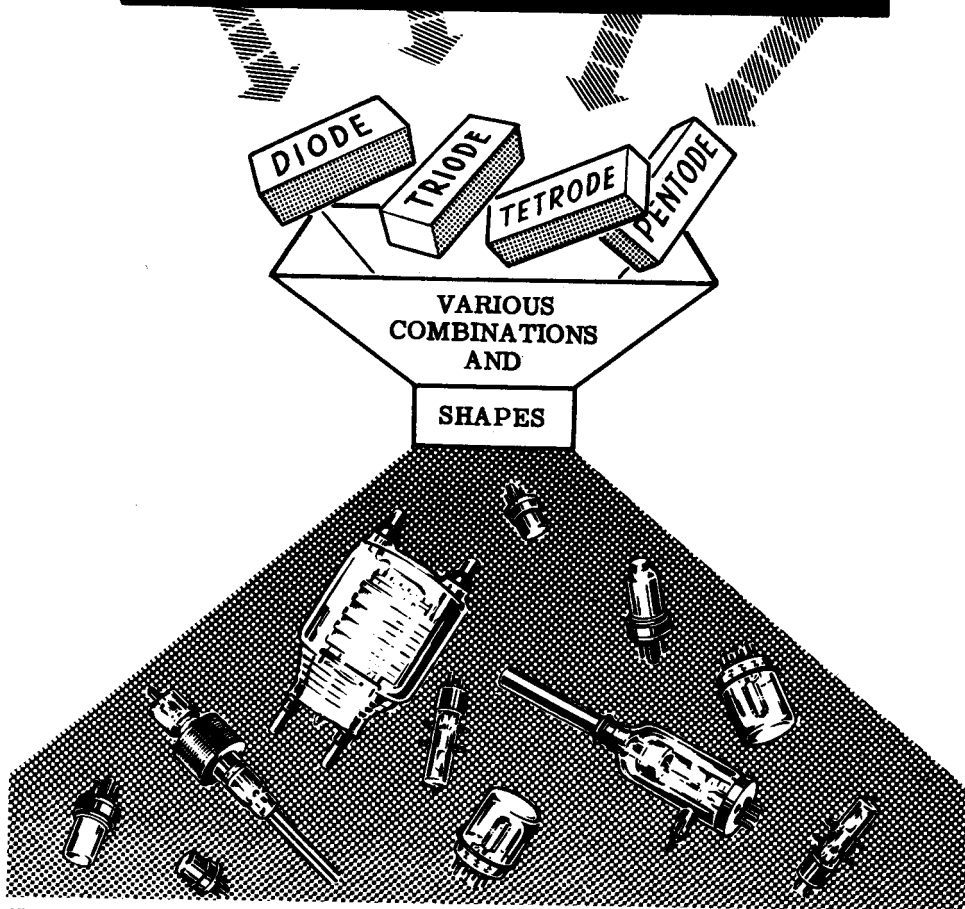

Every electronic circuit has its particular needs, and there is a vacuum tube for every job. Some have to handle small amounts of power, others large amounts. Sometimes they must work with low frequency currents, sometimes high frequencies and sometimes ultra-high frequencies. Sometimes they must be made small enough so that they can fit in a hearing aid or in the fuse container of a high explosive shell. They must be heated by 1 volt, by 2 volts, or sometimes by 6 volts, etc., etc. Sometimes because of limited space available, a diode and a triode must share the same shell. Sometimes two diodes and a triode or a diode, a triode and a pentode must share the same shell!

# INTRODUCTION TO AMPLIFIERS

## Types of Amplifiers

Amplifiers are designed to amplify only those frequencies their type of equipment requires and can be divided into three general groups according to the frequency range of the signals they amplify.

1. **Audio Amplifiers:** These amplify a band of frequencies from 15 cycles per second (cps) to 15,000 cps. This is the range of frequencies which the ear can hear—therefore the name "audio." These amplifiers produce a great deal of the amplification in radio receivers, in intercom equipment, in sonar and in many other types of equipment.
2. **Video Amplifiers:** These are similar to audio amplifiers in that they cover a wide range or band of frequencies and are also similar in design and operation. The frequency band, however, is very much expanded, covering frequencies from 30 cps to 6,000,000 cps and higher. Video amplifiers are used primarily to amplify signals for 'scope presentations in radar and fire control equipment and in television.
3. **Radio Frequency Amplifiers:** Unlike the other types, RF amplifiers amplify a narrow band of frequencies, but this narrow band may be anywhere within the wide range of frequencies from 30,000 cps to several billions of cycles per second. They are used in radar, fire control, sonar, radio receivers and transmitters. When you tune a piece of equipment, such as a home receiver, you are changing the narrow band of frequencies which the set will amplify.

AUDIO AMPLIFIERS IN	VIDEO AMPLIFIERS IN	R. F. AMPLIFIERS IN
<ul style="list-style-type: none"><li>● RADIO RECEIVERS</li><li>● INTERCOM EQUIPMENT</li><li>● SONAR</li></ul>	<ul style="list-style-type: none"><li>● TELEVISION</li><li>● RADAR</li><li>● SONAR</li><li>● FIRE CONTROL GEAR</li></ul>	<ul style="list-style-type: none"><li>● RADAR ● SONAR</li><li>● FIRE CONTROL GEAR</li><li>● RADIO RECEIVERS</li><li>● TRANSMITTERS</li></ul>

Even though they may look different from one another, amplifiers all work in much the same way. In the following work you will learn the operation of audio amplifiers. They come first because they are the simplest of the three and they will help you to understand how the others work.



## THE TRIODE

### Vacuum Tubes and Amplification

One of the most important applications of vacuum tubes is their use to change a small voltage input into a large voltage output. This process of increasing voltages is called amplification.

For example, in an ordinary radio set the tubes take a signal of a few millionths of a volt from the antenna ("aerial") and change it into a powerful signal that is capable of driving a loudspeaker. This requires a great deal of amplification.

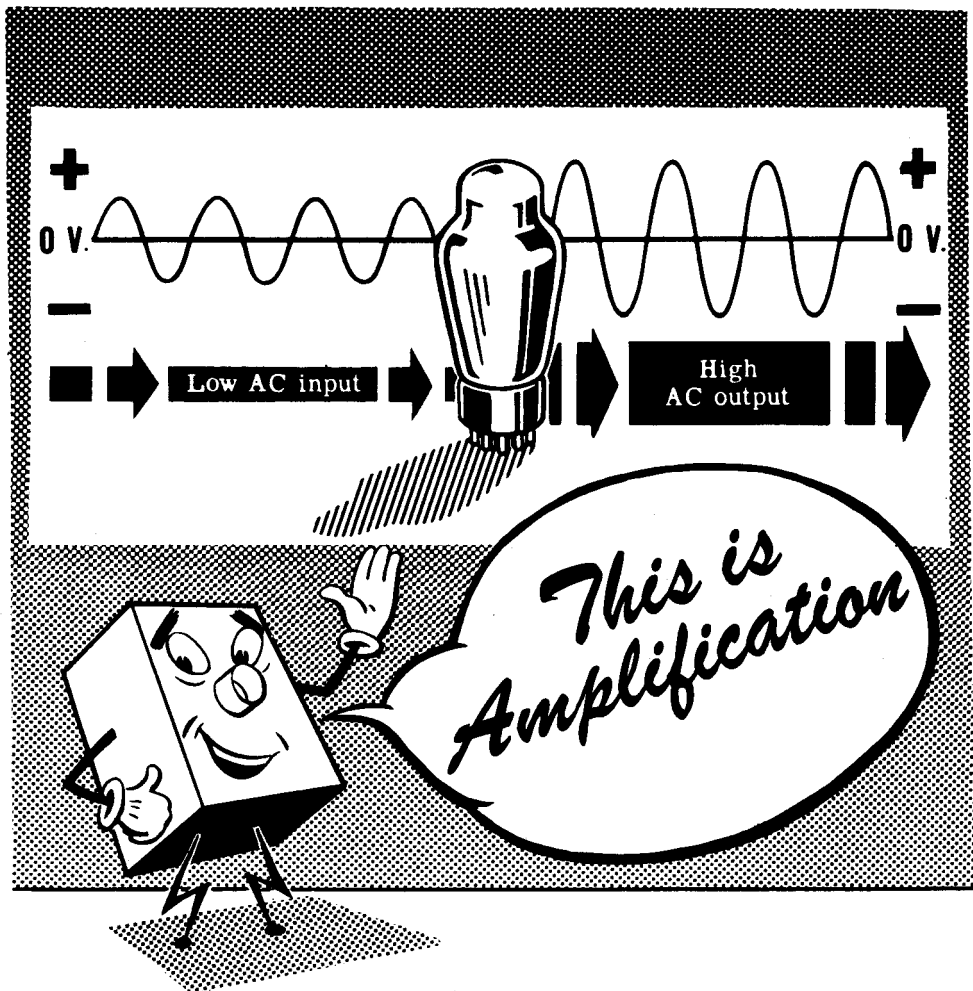

You will find that vacuum tubes are used to produce amplification in receivers, in transmitters, in sonar, in radar and in loran; and it is a foregone conclusion that when new types of electronic equipment come into use, some of the tubes there, too, will be used for amplification.

One of the tubes which can produce amplification is the triode.

# THE TRIODE

## A Typical Triode Tube

### THE CONSTRUCTION OF A TYPICAL *Triode Tube*

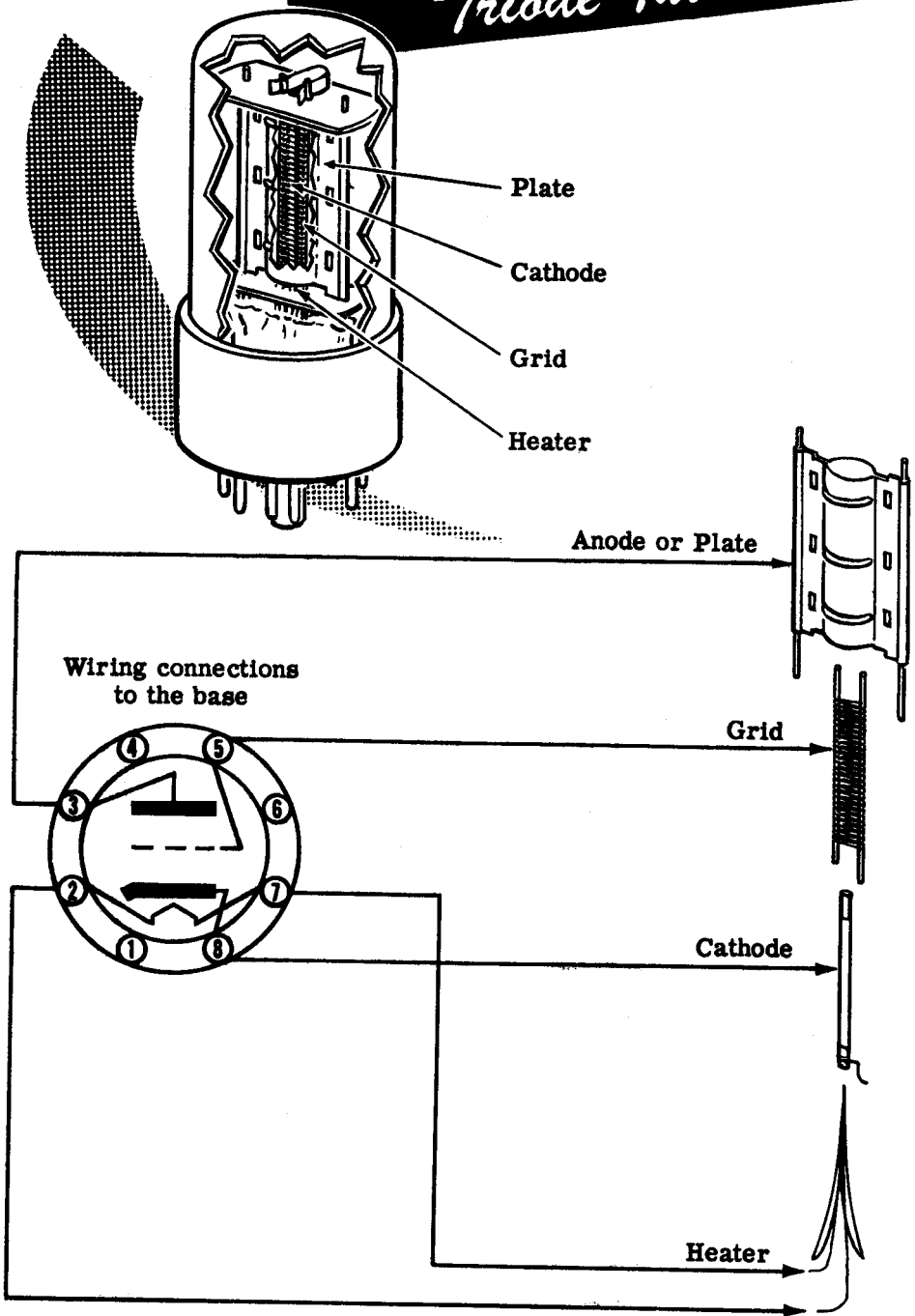

## THE TRIODE

### Seeing How the Triode Works

For purposes of explanation, let's compare the triode to the water system shown below. In the water system, you are interested in controlling the flow of water. One way you can do this is by varying the pressure in the system or, in other words, changing the height of the water tank.

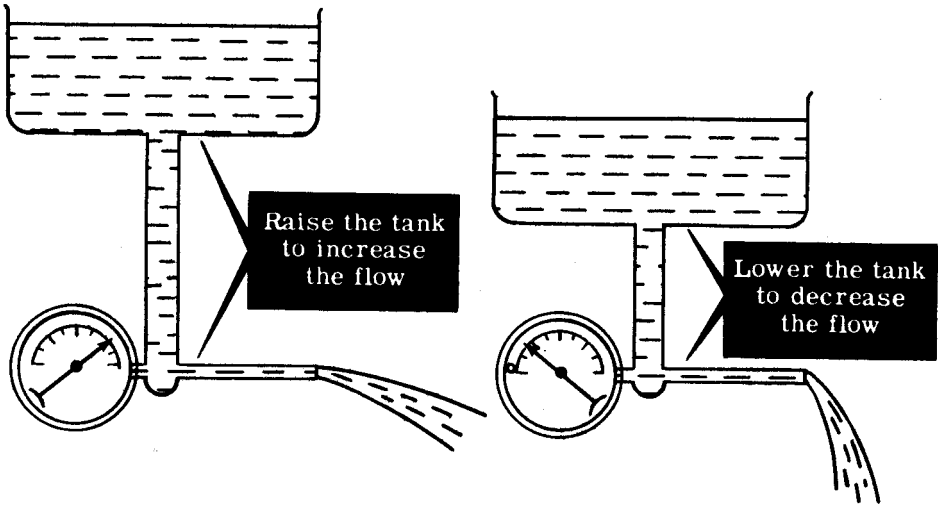

A much more convenient way to vary the flow of water is by using a faucet or valve in the system. Then, by simply turning the faucet, you can control the flow of water. Notice that the water pressure doesn't have to change in order to affect the flow.

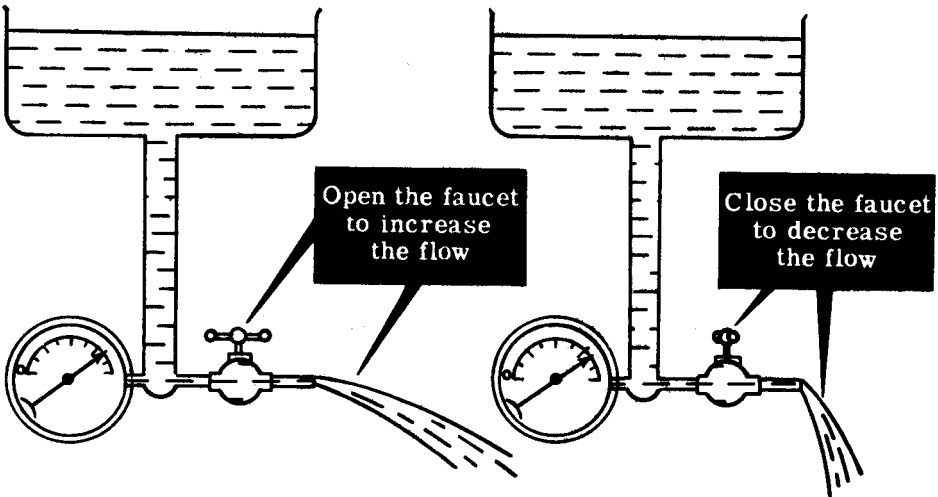

This is similar to the way a triode tube amplifies the flow of current. In the triode an additional element, the grid, is placed in the tube, its purpose being to control the flow of current in the tube just as the faucet controls the flow of water. You will see that a small voltage variation on this element produces a comparatively large current variation in the tube.

## THE TRIODE

### The Control Grid

This additional structure in the triode is called a "grid" or, more specifically, (to distinguish it from other grids found in tetrodes, pentodes, etc.) the "control grid". It is a very thin wire wound like a spiral around the cathode so that tube current can pass right through its spacings.

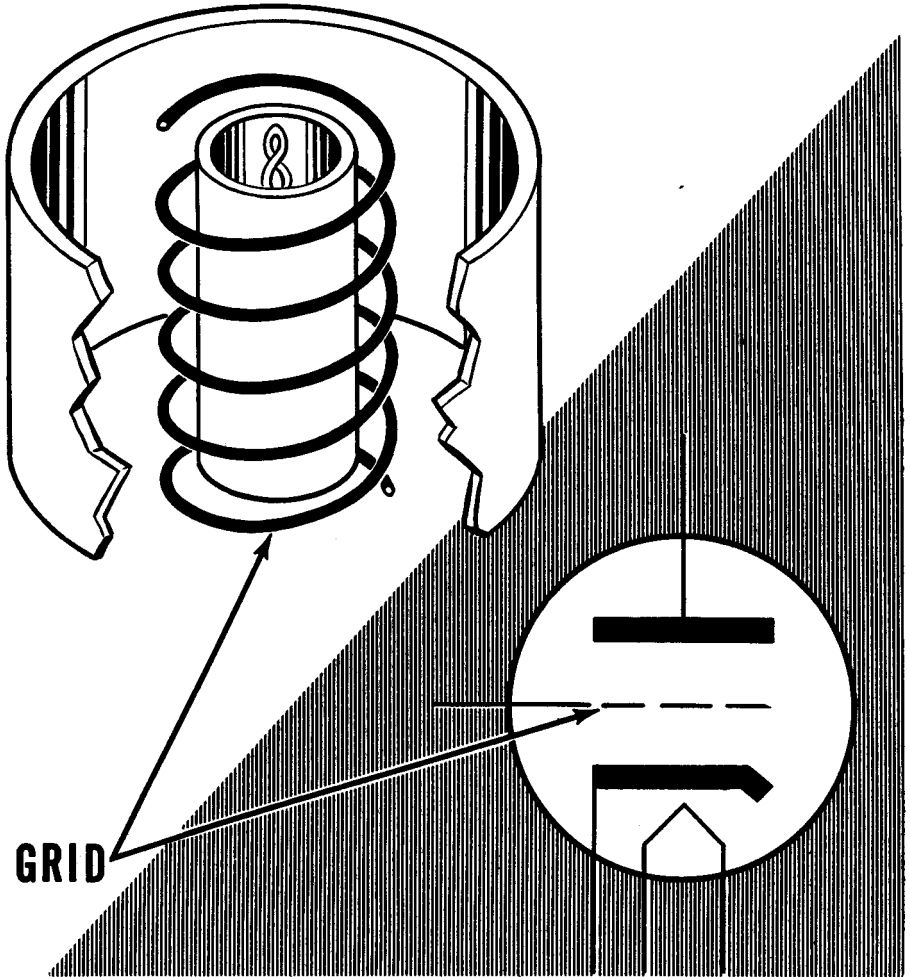

The plate of a triode is normally connected to a high positive voltage,  $B_+$ . The grid of the triode is usually kept at a negative voltage with respect to the cathode. Because electrons are negatively charged, they tend to be repelled by the negative grid. The grid, being closer to the cathode than is the plate, has a greater effect in controlling the tube current than does the positive plate. If the grid becomes less negative, more electrons will get through to the plate; if the grid becomes more negative, fewer electrons will get through to the plate.

## THE TRIODE

### The Control Grid (continued)

This is what happens when you vary the DC voltage (called "bias") on the control grid. The plate is very positive and tends to attract electrons. If the grid is negative, it tends to repel electrons.

#### Cut-off

When the grid is made sufficiently negative, its tendency to hold back the electrons will just equal the plate's pull on the electrons and no current will flow. The point at which the two effects are balanced is called "cut-off." When the grid is more negative than this, the tube is operating "beyond cut-off" and no current flows.

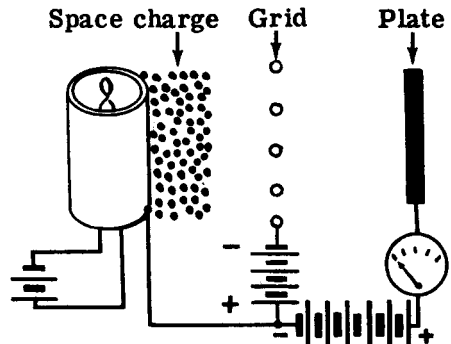

#### Less than cut-off

When the negative charge on the grid is reduced, a few electrons manage to get from the space charge to the plate.

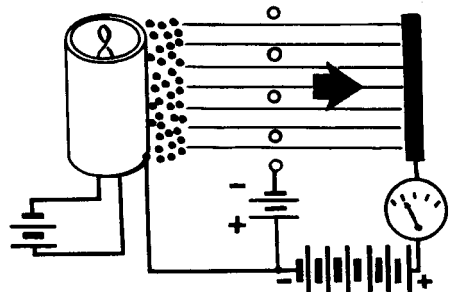

#### Much less than cut-off

When the grid voltage is reduced further or made equal to zero, more current will flow from the space charge to the plate.

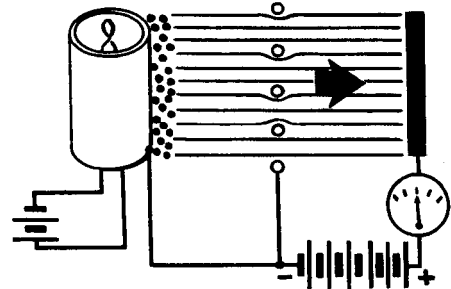

#### Saturation

If the grid is made positive with respect to the cathode, still more current will flow. A point will be reached when the grid is so positive that the electrons flow from the cathode as fast as the cathode can emit them. This is saturation and a still further increase in grid voltage will not cause an increased current to flow.

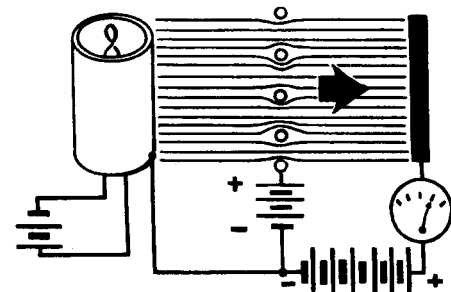

## THE TRIODE

### How the Triode Is Similar to the Diode

Since the only difference between the two tubes is the presence of a grid, you might expect to find several similarities between them.

The triode's cathode and filament are no different than the diode's and, therefore, everything that was said about a diode's electron emission is also true of the triode's. In both tubes the emission (and therefore saturation) depends upon the filament voltage. In both, burned-out filaments are the most common cause of failure and, in both, cathode emission will decrease as a tube is used.

# DIODE...

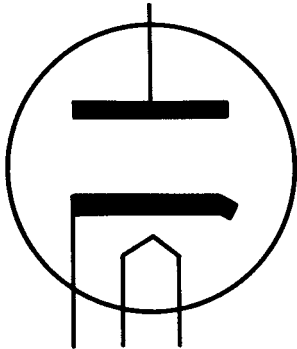

*plus a grid  
equals...*

# TRIODE

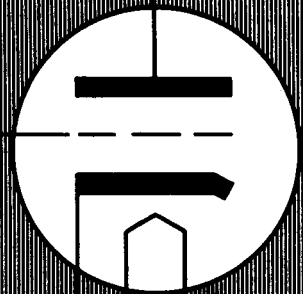

As in the diode, saturation in a triode occurs because there is a limit to the amount of current which the cathode can emit. In the triode, saturation (limiting current) can be reached at a lower value of plate voltage if a positive voltage is applied to the grid; in the diode, of course, it depends only on the plate voltage.

On the other hand, if the grid is made sufficiently negative, no current will flow. The value of grid voltage which reduces the current to zero is called the "cut-off" voltage. Increasing the negative grid voltage beyond this point will have no effect since the tube is already cut off. Cut-off also depends upon the triode's plate voltage; with a more positive plate voltage, a more negative grid voltage will be necessary to produce cut-off.

In a diode current flows only when the plate is positive, and no current flows when the plate is negative. In a triode, however, the plate can be positive and still no current flows if the grid is sufficiently negative. The cut-off point of a triode depends upon the particular tube (how it is constructed) and upon the value of plate voltage.

# THE TRIODE

## How Amplifiers Work

You have found out a little about how important amplifier circuits are in equipment. Now you are ready to find out how they work.

It's all very simple—a vacuum tube does the entire job of amplifying if you provide it with the proper operating voltages and connections. If you supply the proper voltages to the various tube elements, a small change in voltage applied to the grid causes a large change in voltage on the plate. The production of a large voltage change from a small voltage change is called "amplification."

You learned that a good way for you to picture the operation of a grid in a vacuum tube was to think of the grid as a valve in a water pipe. The British are so fond of this explanation that, to this day, they call a vacuum tube a "valve." When the grid of the tube is very negative, the "valve" is closed and there is little or no flow of electrons from the cathode to the plate. When the grid voltage is changed so that it becomes only slightly negative, the "valve" is nearly wide open and there is a large flow of electrons from the cathode to the plate.

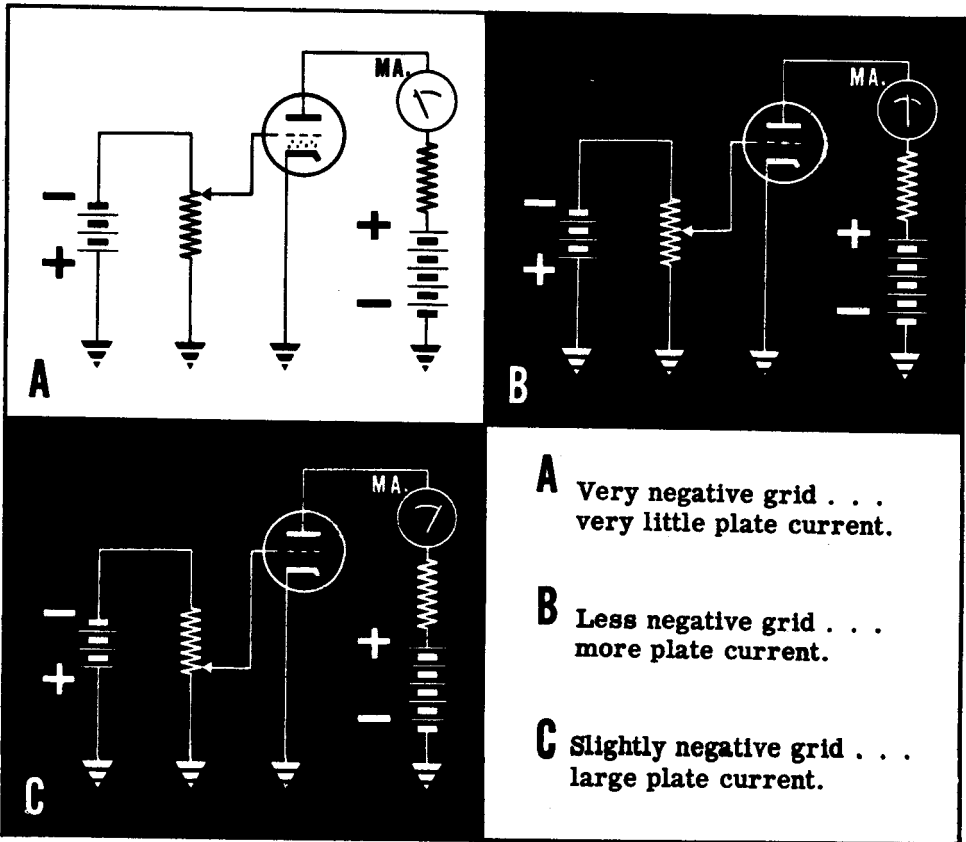

## THE TRIODE

### How Amplifiers Work (continued)

Now a small flow of electrons from the cathode to the plate means that only a small number of electrons flow from the plate to the B+ lead of the power supply, and a large flow of electrons from cathode to plate means a large current flow from the plate to the B+ lead of the power supply.

A change in current appearing at the plate of a tube is of no direct use, but, if this plate current change can become a plate voltage change, the original voltage change appearing at the grid will have been amplified. The way to accomplish this is to put a resistor between the plate and B+. You know that whenever the electron flow through a resistance changes, a voltage change is produced across that resistance. This voltage change is many times larger than the voltage change on the grid. Since the plate or output voltage changes by the same amount as the voltage across the resistor, the amplified grid voltage change appears at the output.

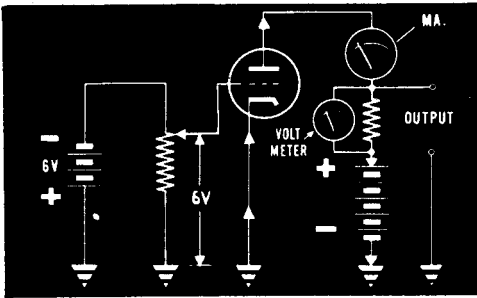

- VERY NEGATIVE GRID
- VERY LITTLE PLATE CURRENT
- VERY LOW VOLTAGE DROP ACROSS PLATE LOAD RESISTOR

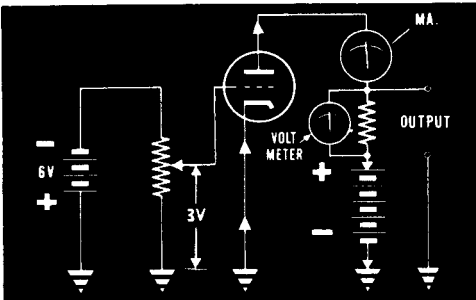

- LESS NEGATIVE GRID
- MORE PLATE CURRENT
- LARGER VOLTAGE DROP ACROSS PLATE LOAD RESISTOR

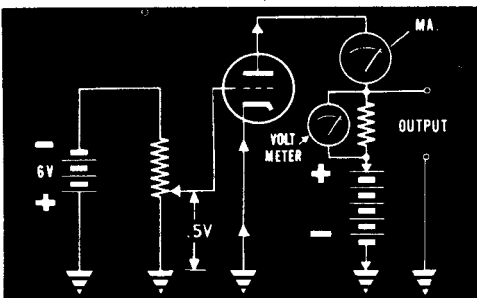

- SLIGHTLY NEGATIVE GRID
- LARGE PLATE CURRENT
- VERY LARGE VOLTAGE DROP ACROSS PLATE LOAD RESISTOR

Using this circuit with certain types of vacuum tubes, the change in plate voltage can be made more than 200 times the change in grid voltage—a voltage gain or amplification of over 200.



## THE TRIODE

### How Amplifiers Work (continued)

Let's take a look at a triode circuit and see how amplification is accomplished. The cathode-to-plate current flows through the load resistor which is in series with the plate and causes a voltage drop across the plate. Therefore, as long as current is flowing, the voltage on the plate is less than B+ by an amount equal to the drop across the load.

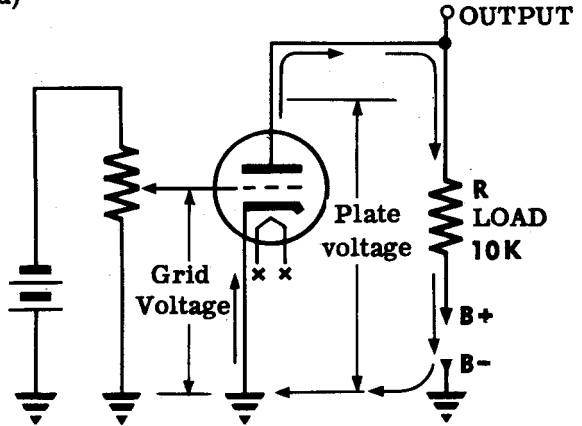

Now a slight change in grid voltage causes a large change in plate current and this causes a corresponding change in the voltage drop across the load resistor. If the voltage drop across the load resistor increases, the plate voltage will decrease by the same amount. This change in plate voltage is called the "output voltage." Because a change in grid voltage produces a much larger change in plate voltage, the triode amplifies.

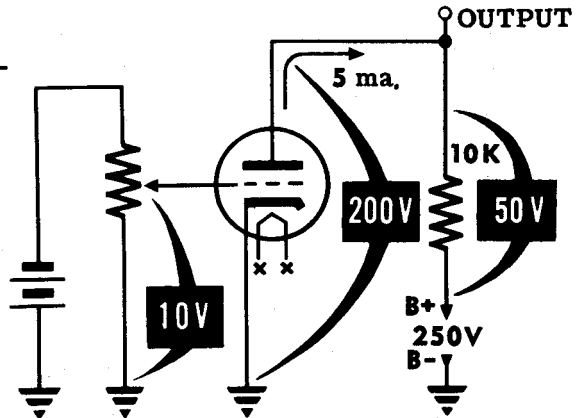

Here is an example of what happens in an actual tube: With the grid voltage = -10 volts, load resistor = 10K ohms, B+ = 250V, the plate current that flows is 5 ma. This current causes a voltage drop across the load of  $E = IR = .005 \times 10,000 = 50$  volts. Therefore, the plate voltage is 200 volts (250 - 50).

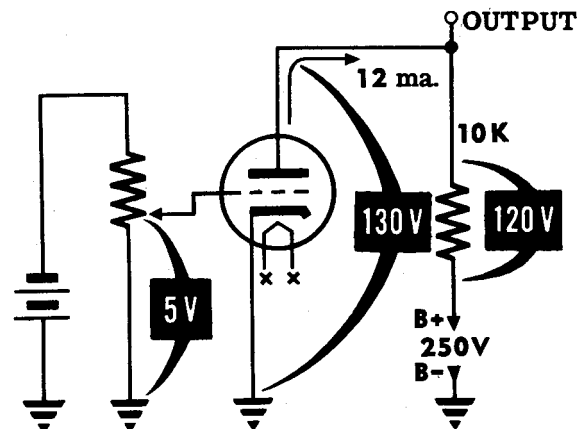

Now let's change the grid voltage from -10 volts to -5 volts (less negative). The current increases to about 12 ma., the drop across the load is 120 volts—an increase of 70V, and the voltage on the plate is now only 130 volts—a decrease of 70V. Note that the sum of these two voltages still adds up to the B+ voltage of 250V. Thus, a change of only 5 volts on the grid has changed the plate voltage 70 volts—an amplification of 14 times.

## THE TRIODE

### Tube Characteristics—Amplification Factor

Since the grid voltage and plate voltage can be used to control the flow of current to the plate, it is important to see which does the better job. If you look at the results of tests, you will see that a small change in grid voltage can produce a large change in plate current while a much larger change in plate voltage is necessary to produce the same plate current change.

The ratio of the effectiveness of the grid and plate in controlling plate current is called Mu, and the Greek letter  $\mu$  is used to represent it.

From these results we can say that the grid of the tube is much more effective than the plate in controlling plate current.

$\mu = \frac{\text{Change in plate voltage}}{\text{Change in grid voltage}}$  to produce the same change in plate current.

Actually the Mu of tube is much more than a ratio. It tells you how much a vacuum tube is able to amplify a signal that is applied to its grid. For example, suppose you find that when the grid voltage is changed from  $-2$  to  $-4$  (a change of  $2V$ ) the plate current changed the same amount as it did when the plate voltage was changed from  $140V$  to  $100V$  (a change of  $40V$ ). The ratio of these two voltage changes is  $20$  to  $1$ , which means that if one volt of AC is applied to the grid of the tube,  $20$  volts of AC will appear in the plate circuit. The tube, therefore, has amplified an AC signal  $20$  times. For this reason the Mu of a tube is also known as the amplification factor.

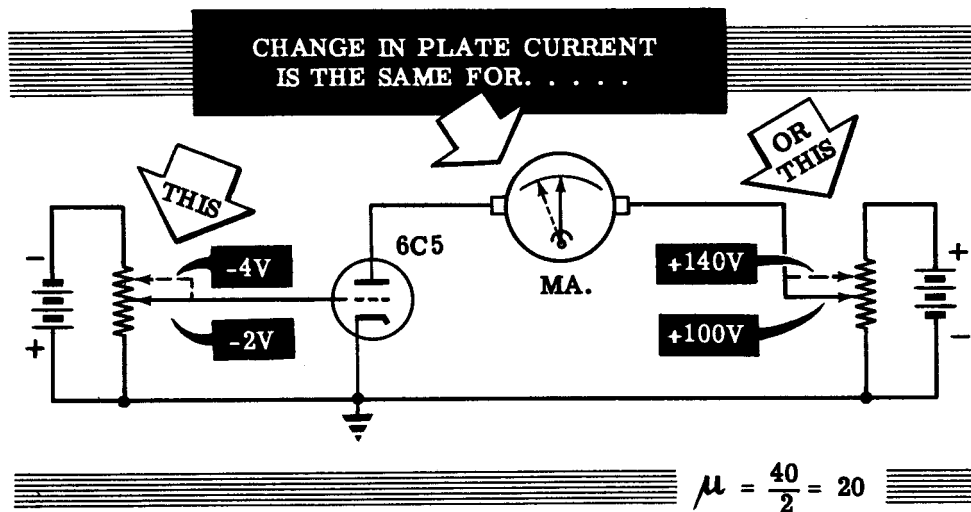

## THE TRIODE

### Tube Characteristics—Plate Resistance

The plate resistance of a tube is the internal opposition offered, between the cathode and plate, to the flow of the alternating component of plate current. When the tube is operating with an AC voltage on the grid, the number of electrons flowing to the plate changes, and this affects the internal or plate resistance of the tube.

This plate resistance is the ratio of a change in plate voltage to a change in plate current with the grid voltage constant. For example, the 6C5's plate resistance can be determined from the results of a test where the plate voltage will be varied and plate current values recorded for a constant grid voltage. Suppose the test curve indicates that a change in plate voltage from 100V to 150V produced a change in plate current of 5 ma. Since the plate resistance is—

$$r_p = \frac{\text{Change in plate voltage}}{\text{Change in plate current}} \text{—for a constant grid voltage}$$

then

$$r_p = \frac{50}{.005} = 10,000 \text{ ohms.}$$

The plate resistance is not the same for all vacuum tubes. For triodes it will range from 2,000 to 100,000 ohms and for pentodes it may be as high as 1 megohm.

### DETERMINING THE *Plate Resistance* OF A TRIODE

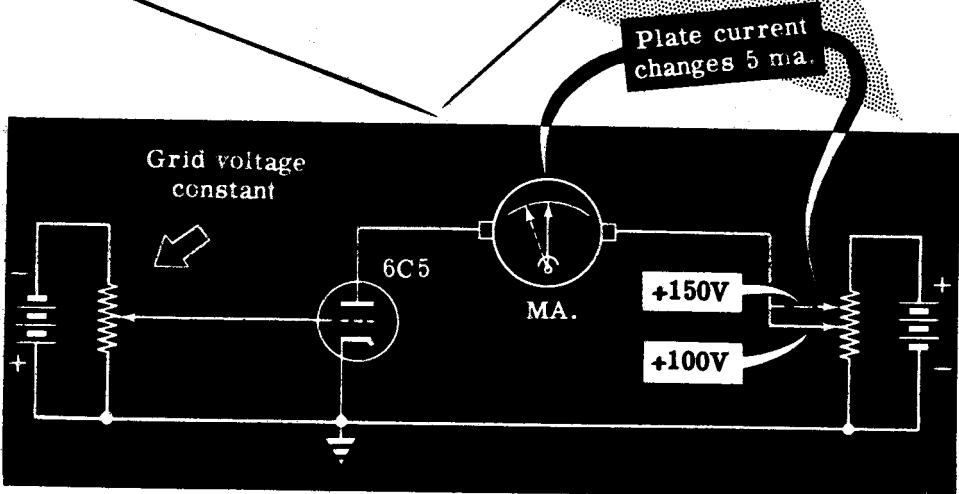

## THE TRIODE

### Tube Characteristics—Transconductance

So far you have learned about two characteristics of vacuum tubes—the  $\mu$  or amplification factor and the internal plate resistance— $r_p$ . Another characteristic—transconductance—is obtained from the relationship of  $\mu$  and  $r_p$ . Transconductance is a measure of how effective the grid is in controlling plate current and it is expressed as the ratio of  $\mu$  to  $r_p$ .

$$\text{Transconductance } (g_m) = \frac{\mu}{r_p} \text{ in mhos}$$

In simplified form,  $g_m$  represents the effect of a changing grid voltage on plate current with the plate voltage held constant.

The  $g_m$  of a tube is expressed in micromhos which is one millionth of a mho, pronounced "mo"—ohm spelled backwards. It is used as the unit of transconductance since conductance is the opposite of resistance.

Using the  $\mu$  and  $r_p$  from the previous sheets, the  $g_m$  of the 6C5 can be determined.

$$g_m = \frac{\mu}{r_p} = \frac{20}{10,000} = .002 \text{ mhos}$$

$$g_m = 2000 \text{ micromhos}$$

For most vacuum tubes, the transconductance is usually several thousand micromhos. Tubes with a high  $\mu$  and low  $r_p$  will have a high  $g_m$ .

### DETERMINING THE *Transconductance* OF A TRIODE

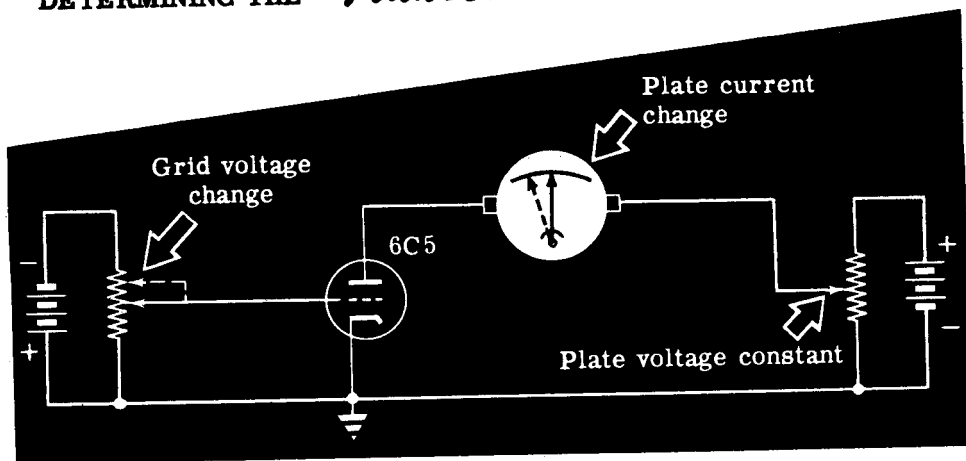

# THE TRIODE

## Review of Triode Characteristics

**Curve 1:** You can see that cut-off for this particular tube is about -14 volts with 200 volts on the plate. As the grid voltage is made less negative, the current increases along the  $E_g-I_p$  curve. A portion of the curve is straight or linear. On this linear portion the plate current variations are uniformly proportional to the grid voltage variations. In this linear region a change of 2 volts on the grid produces a change of about 4 ma. in the plate current. The graph shown here is called the  $E_g-I_p$  curve.  $E_g$  = grid voltage and  $I_p$  = plate current.

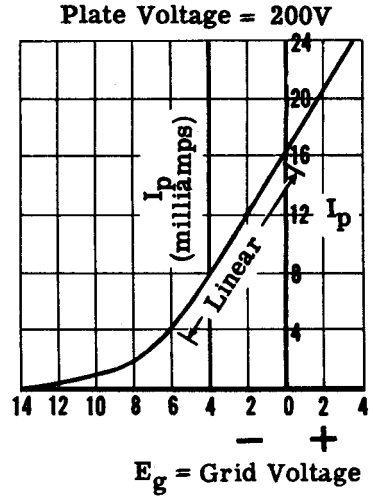

**Curve 2:** With the grid voltage set at -8 volts, it is seen that changes of plate voltage affect the plate current. But a 10-volt change on the plate causes only a very small change in the plate current. By comparing the results in curve 1 and curve 2, you can see that the grid exerts a greater control on the plate current than does the plate.

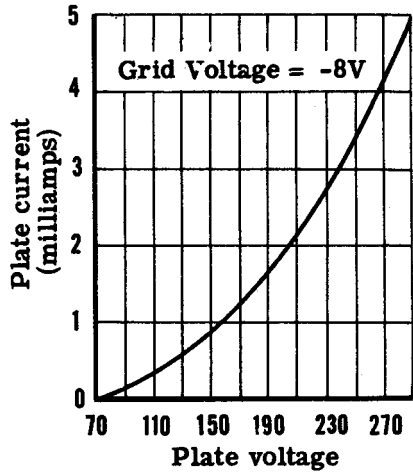

**Curve 3:** While the tube is cut off (from grid voltages of -14 and beyond) no current flows and there is no voltage drop across the plate load resistor. The plate voltage is equal to  $B+$  while the tube is cut-off. When the grid voltage becomes less negative, plate current flows and a voltage drop is developed across the load resistor, causing the plate voltage to drop. Along the linear portion of the curve, a 2-volt change on the grid produces a change of about 30 volts on the plate. This is a gain (amplification) of 15.

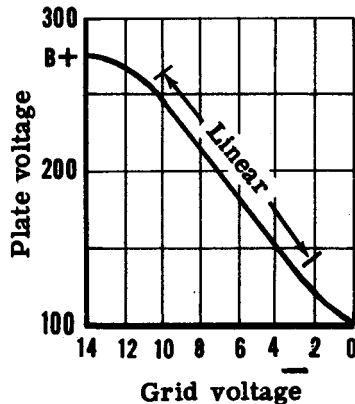

# THE TRIODE AMPLIFIER

## Grid Bias Voltage

You should know how the plate current of a triode behaves under different operating conditions. If you look at curve 1 on the previous page, you will see that when the grid is made positive with respect to the cathode, the plate current rises to high values. When the grid is made sufficiently negative with respect to the cathode, plate current drops to zero. These are the extreme conditions in the operation of a triode.

We are concerned with triodes used as amplifiers, and for this purpose they are normally operated with the grid negative to prevent distortion of the signal. This confines the operation to the left portion of the  $E_g$ - $I_p$  curve (curve 1). The voltage which keeps the grid negative is called the "grid bias voltage." Grid biasing is simply the process of making the grid negative with respect to the cathode.

When a tube is used as an amplifier, two voltages in series are applied between grid and cathode:

1. The negative DC grid bias voltage which fixes the point of operation on the  $E_g$ - $I_p$  curve. This bias voltage may be obtained from a battery or any other source of DC voltage. Various types of bias supplies will be discussed later.
2. The AC signal voltage, which for the present will be in the audio frequency range.

In the sheets which follow, you will see how the AC signal adds to and subtracts from the bias voltage to produce corresponding changes in plate current.

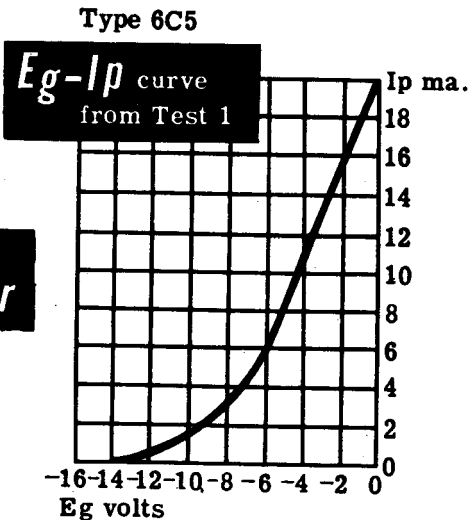
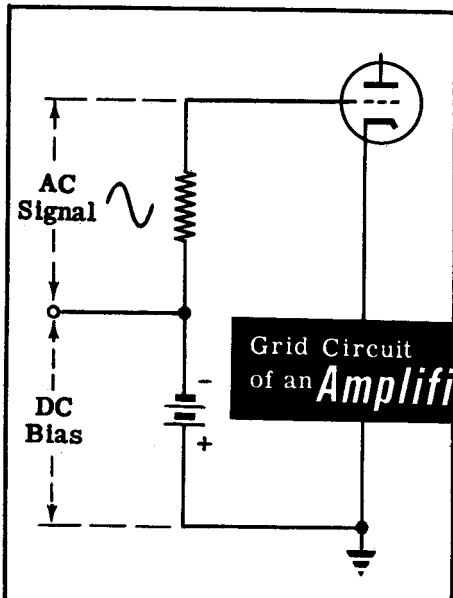

# THE TRIODE AMPLIFIER

## Grid Bias Voltage (continued)

If an AC signal is applied to the grid, the current flowing in the plate circuit will vary in the same manner as the signal voltage. The positive half cycle of the applied signal voltage is in series opposing with the bias voltage and therefore subtracts from it. The negative half cycle of the signal voltage is in series aiding with the bias voltage so that addition of the two voltages takes place. As a result, the AC signal voltage causes the grid to cathode voltage to be alternately less negative and more negative. This varying negative voltage between grid and cathode allows more and less current to flow so that the plate current variations will be a duplicate of the applied signal voltage.

**THIS** + **THIS**

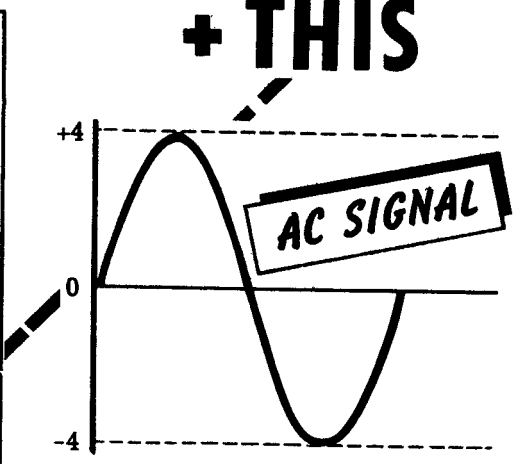
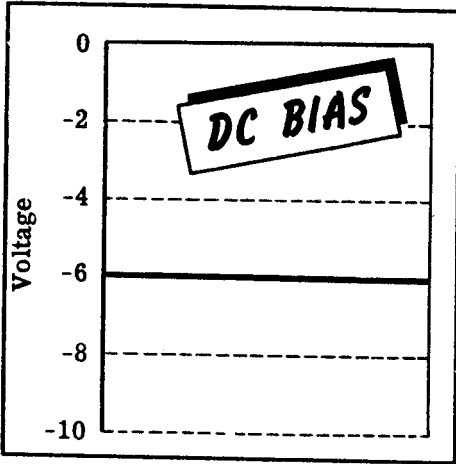

-6  
+4  
-2

**= THIS**

COMBINATION OF DC BIAS  
AND AC Signal Voltage

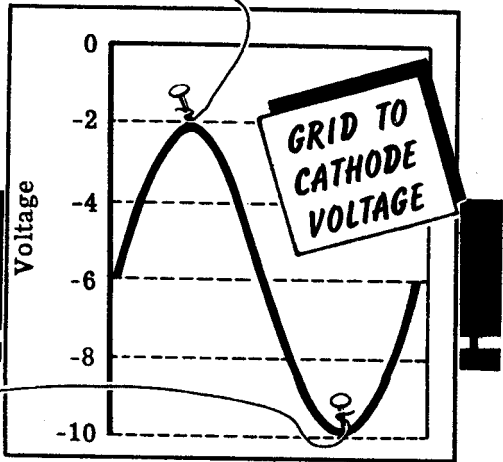

-6  
-4  
-10

# THE TRIODE AMPLIFIER

## Grid Bias Voltage (continued)

Let us consider the following example which will illustrate the points just made. Suppose a 6C5 triode is connected in a circuit with  $-4V$  bias voltage applied to the grid and  $+200V$  applied to the plate. With no signal applied, the plate current will be a steady  $11\text{ ma}$ . This can be seen by referring to the  $E_g$ - $I_p$  curve.

When an AC signal of  $2V$  is applied to the grid, the positive half cycle will subtract  $2V$  from the bias causing the grid to cathode voltage to change from  $-4V$  to  $-2V$ . The negative half cycle will add to the bias and cause the grid to cathode voltage to change from  $-4V$  to  $-6V$ . You can see that the grid to cathode voltage is varying from  $-2V$  to  $-6V$  around the  $-4V$  bias.

The plate current depends on the amount of negative voltage between grid and cathode. This negative voltage is now varying in the same manner as the applied signal. Therefore, the plate current will vary in accordance with the applied signal.

When the grid voltage varies so that the plate current varies in accordance with the applied AC signal, the amplifier is called "Class A," and is operating on the linear portion of the  $E_g$ - $I_p$  curve. You will learn more about the classes of operation a little later.

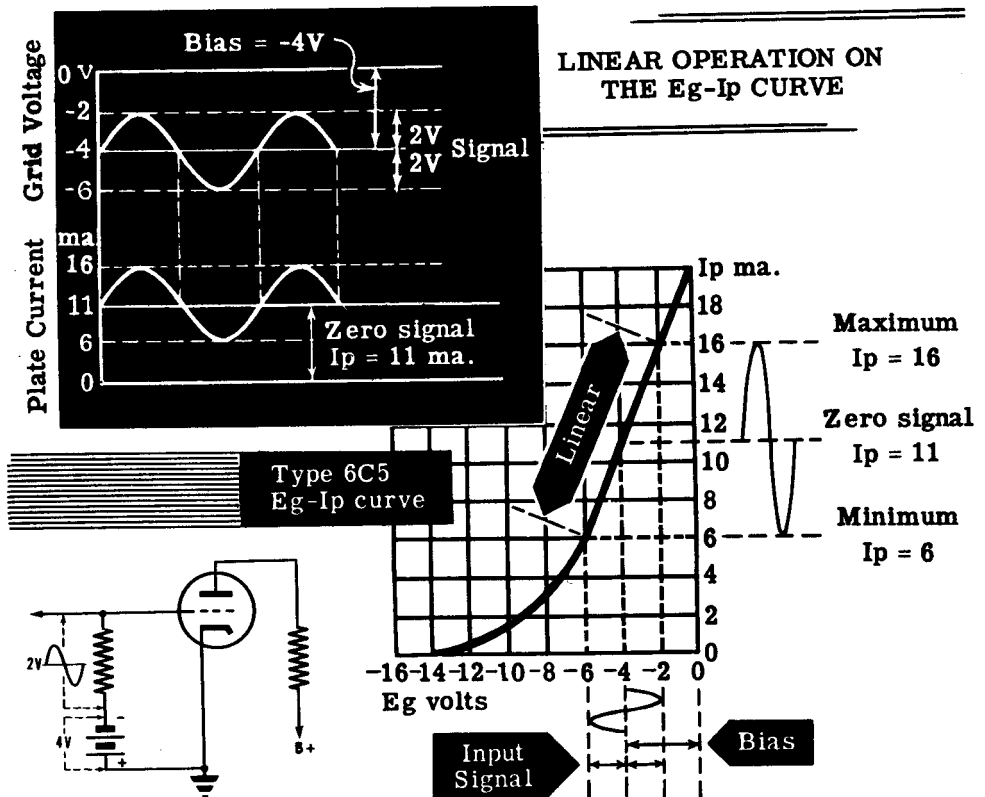



# THE TRIODE AMPLIFIER

## Why Proper Bias Is Necessary

To obtain an amplified output voltage at the plate we must use the plate current variation. In the example on the previous sheet, a 5 ma. AC component was produced in the plate circuit by applying a 2V AC signal to the grid.

Suppose we look at the plate circuit of the triode. If an 8,000 ohm plate load resistor ( $R_L$ ) is used, the steady or zero-signal plate current of 11 ma. will produce a DC voltage drop across the load of  $E = I \times R = .011 \times 8000 = 88V$ . The DC plate voltage is 200V and the total DC voltage ( $B+$ ) is the sum of the load voltage and plate voltage or 288V.

## DC Voltage Distribution ... IN A TRIODE AMPLIFIER

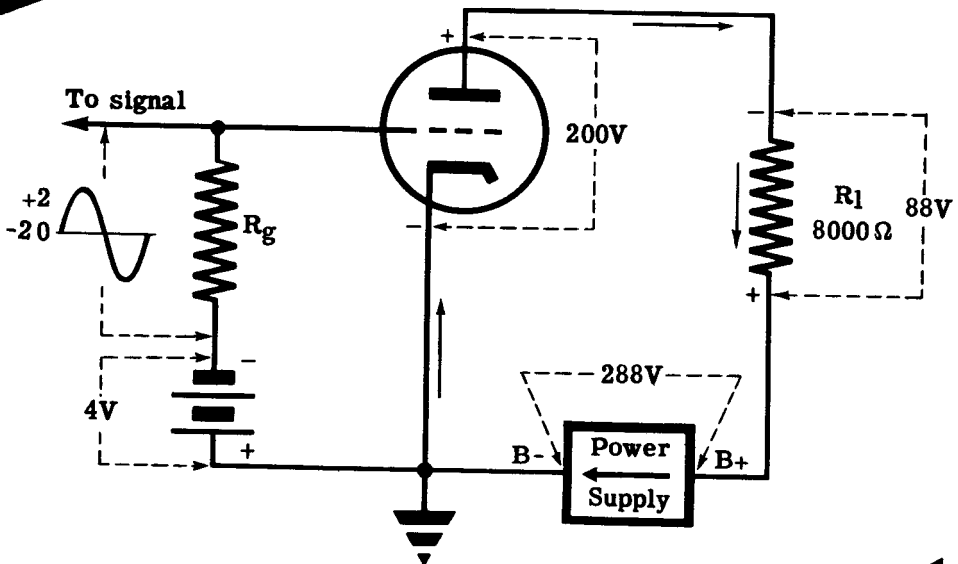

On the next sheet you will see how the load voltage and the plate voltage change when the signal is applied to the grid.

# THE TRIODE AMPLIFIER

## Why Proper Bias Is Necessary (continued)

When the signal is applied to the grid, the plate current increases to 16 ma. (5 ma. increase) and decreases to 6 ma. (5 ma. decrease). When 16 ma. flows through the load, the voltage drop across the load will be  $E = I \times R = .016 \times 8000 = 128V$ , an increase of 40V ( $128 - 88 = 40V$ ). This will make the plate voltage decrease 40V since the total voltage must always add up to the B+ voltage of 288V. Therefore, the plate voltage will decrease from 200V to 160V. (Note:  $160V + 128V = 288V$ )

When the plate current decreases to 6 ma. the voltage drop across the load will be  $E = I \times R = .006 \times 8000 = 48V$ , a 40V decrease from its steady value of 88V. Since the total voltage must still be up to 288V, the plate voltage will increase from its steady 200V to 240V. (Note:  $240V + 48V = 288V$ ).

You can see from the illustration below that the 5 ma. AC component of plate current produces a 40 volt variation across the plate load resistor and an equal and opposite variation in plate voltage. Since a 2V AC signal on the grid initially produced the plate current variation, the 40V signal at the plate is an amplified version of the grid signal.

A 2V signal on the grid has produced a 40V signal at the plate which means that we have amplified the signal 20 times. Note that this amplified signal at the plate is 180 degrees out of phase with the signal on the grid.

You will see on the next sheet that the correct bias is necessary if the plate current variation and likewise the plate voltage variation is to be an exact duplicate of the grid signal.

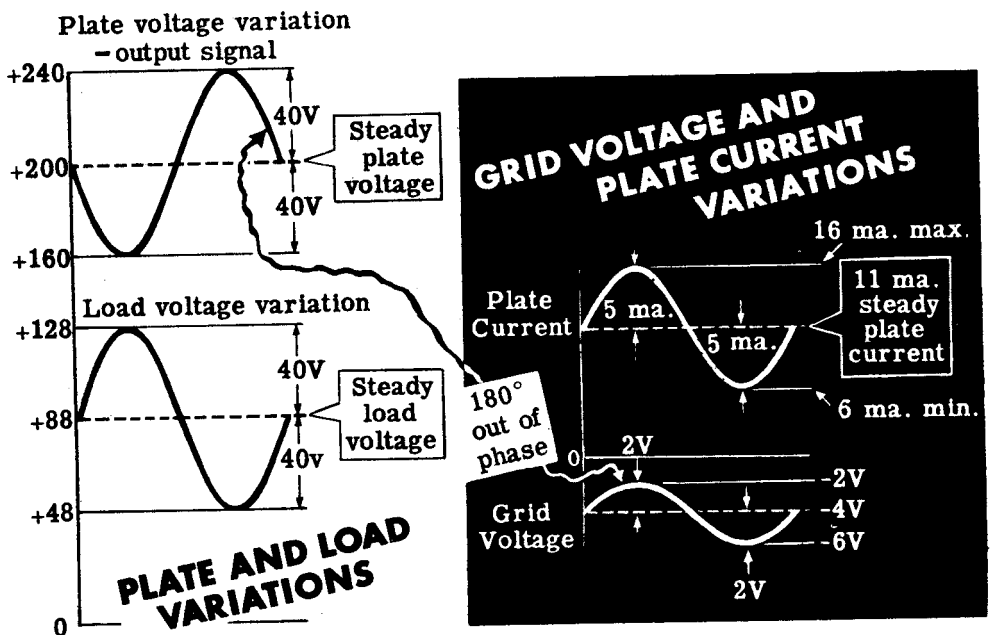

# THE TRIODE AMPLIFIER

## Why Proper Bias Is Necessary (continued)

Notice that although the signal itself was positive during one half cycle, the grid to cathode voltage was never positive—it just became more negative or less negative. The bias point for this amplifier was selected so that it fell in the center of the straight-line or linear portion of the Eg- $I_p$  curve. Operation on the linear portion is essential if the output wave form is to have the same shape as the input wave form. Operating at incorrect bias voltages will produce distortion of one form or another. If too much bias is used, (making the grid voltage more negative) the signal will drive the tube into cut-off during the negative half cycle and produce a distorted plate current variation. If too little bias is used, the signal will drive the grid positive during the positive half cycle. This will cause the grid to take some electrons from the cathode that would normally have gone to the plate. Again the result is a distorted plate current variation. These conditions are illustrated below.

Distortion will result with the correct bias voltage if the input signal is too large. The large signal will drive the grid into both the positive and the cut-off regions—producing distortion.

You can now see that proper bias is necessary if the plate current variation is to look exactly like the grid signal variation. If the amplifier tube is biased in the center of the linear portion of the Eg- $I_p$  curve and the tube is not overdriven (excessive signal), very little distortion will result. Incorrect bias will result in a distorted output signal.

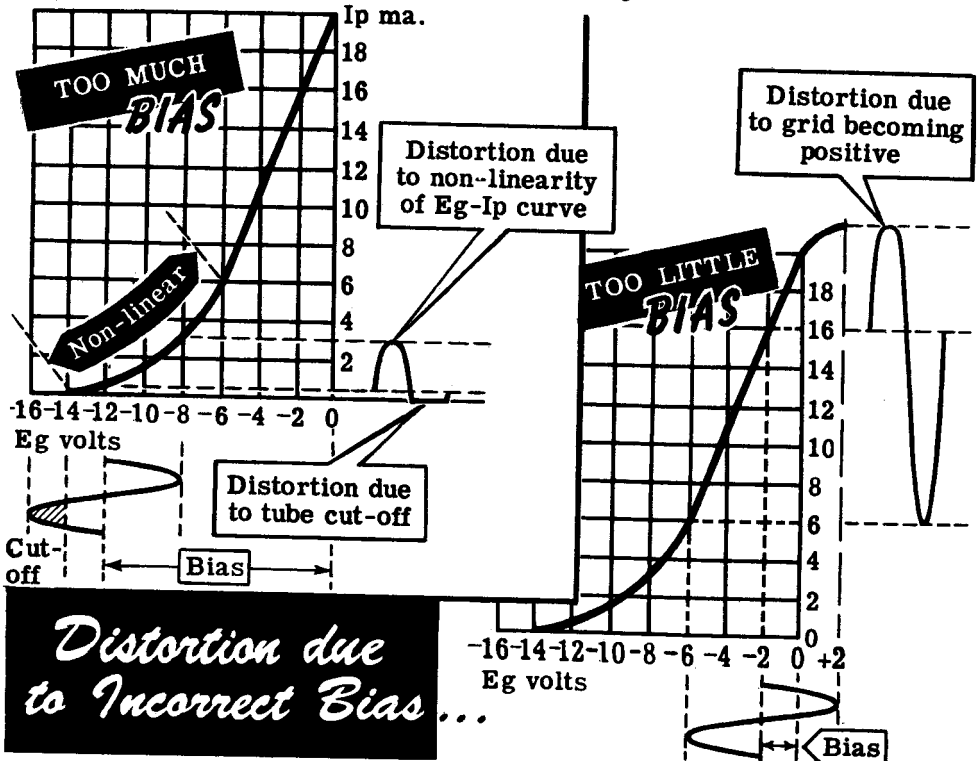

# THE TRIODE AMPLIFIER

## Classes of Amplifiers

The class of an amplifier is determined by its point of operation on the Eg- $I_p$  curve. There are three major classes of amplifiers—Class A, B and C. Class A amplifiers are biased to operate in the center of the linear portion of the Eg- $I_p$  curve. The amplifier described in the previous sheets is a Class A amplifier. Class B amplifiers are biased to operate near cut-off and Class C amplifiers operate at a point where the bias voltage is equal to twice the cut-off voltage of the tube.

The figure below shows the bias voltages for the three different classes of amplifiers. For this particular tube, the bias would be  $-2V$  for Class A operation. Since Class B operates at cut-off, its bias voltage must be  $-4V$ . For Class C operation, the bias must be  $-8V$  because a Class C amplifier operates at a bias equal to twice the cut-off value.

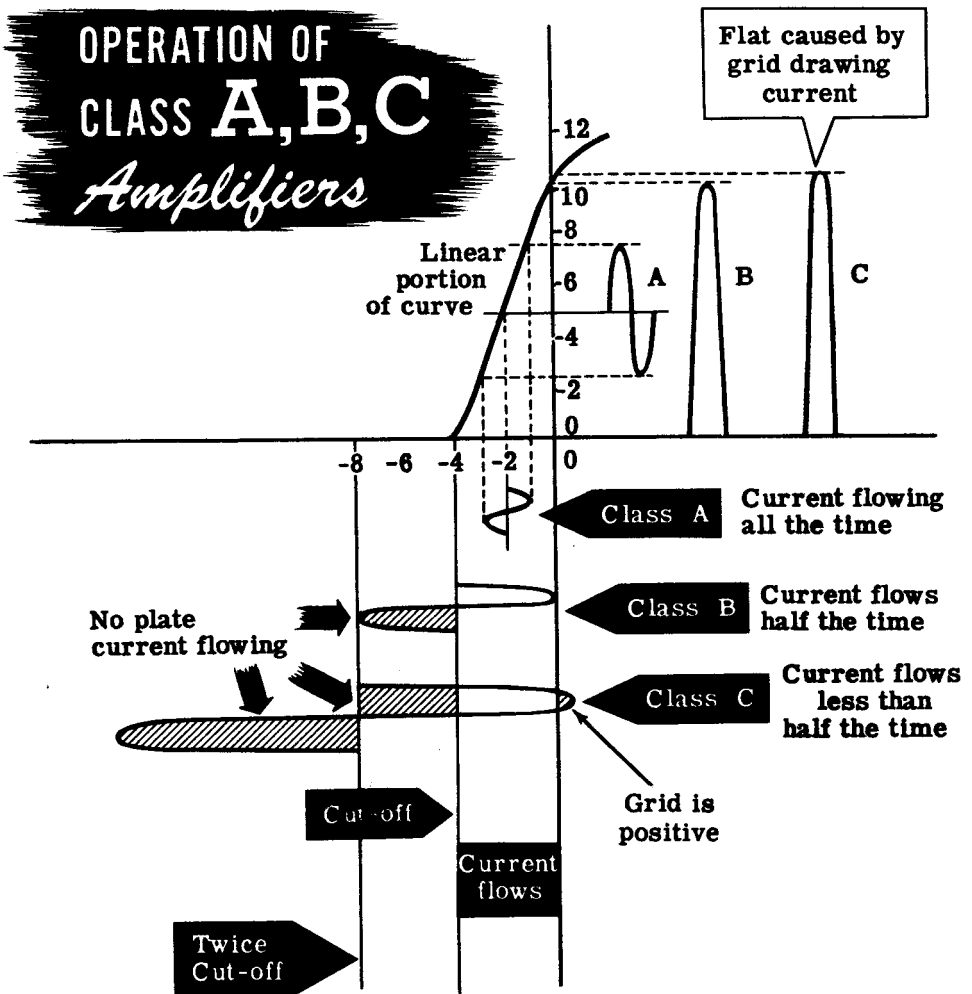

## THE TRIODE AMPLIFIER

### Classes of Amplifiers (continued)

The figure shown on the previous sheet is a comparison of the operating characteristics of Class A, B, and C amplifiers. This is what you should see from the illustration—

#### Class A

The signal is small. It is never large enough to drive the grid either positive or beyond cut-off. Plate current flows during the complete cycle of signal input. The plate current variation is an exact duplicate of the grid signal.

#### Class B

The signal is larger than for Class A. The grid may be driven positive. The signal drives the grid beyond cut-off for approximately half the input cycle. Only the positive half cycle of input appears in the plate circuit. The total plate current change is much greater than the change produced by Class A operation. Plate current flows for approximately half the complete cycle. Plate current is zero when no signal is put into the grid.

#### Class C

The applied signal is the largest of the three classes. The grid is driven beyond cut-off and into the positive grid region. The plate current variation is the largest of the three classes. The peak of the current wave has a dip because the control grid is drawing current, thereby reducing the amount of current available to the plate. Plate current flows for less than half a cycle of input voltage. Without a signal on the grid, no plate current flows. A large signal voltage is necessary to drive the grid positive during each cycle. This class is used only in RF (radio frequency) power amplifiers.

The Class A amplifier is used primarily as a voltage amplifier. Class B and Class C amplifiers are used as power amplifiers and are designed to deliver high currents.

There are combinations of Class A and Class B amplifiers and these are called Class AB<sub>1</sub> and AB<sub>2</sub>. Class AB<sub>1</sub> amplifiers are biased to a point slightly more negative than Class A amplifiers. Class AB<sub>2</sub> amplifiers are biased to a point slightly less negative than that of Class B. These classes of operation are actually compromises between Class A and Class B.

# THE TRIODE AMPLIFIER

## Battery Bias

Battery bias was chosen for the first illustration of bias because it is the easiest to understand. In actual practice, you will find it used only in the laboratory or for experimental work. The battery type is reliable and efficient, but the size and weight of batteries make it difficult to use in most equipment.

Whenever batteries are used as a source of bias voltage, it is desirable to use a combination of cells in series that add up to the required voltage. With this arrangement, it is not necessary to use regulating devices, such as potentiometers, which draw current from the battery and gradually consume its power. Most bias or "C" batteries are made in multiples of 4-1/2 volts—4-1/2, 9, 18 volts and higher. These batteries are tapped for intermediate voltages. The negative terminal of the battery is connected to the grid through the resistor  $R_g$ , the positive terminal is connected to the cathode. This makes the grid negative with respect to the cathode.

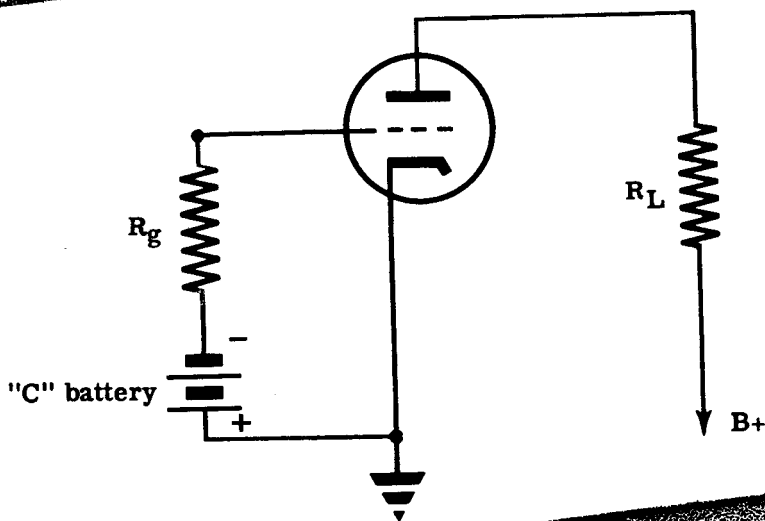

*Battery* **BIAS**

# THE TRIODE AMPLIFIER

## Power Supply Bias

Rectifier power supplies replace "B" batteries in the plate circuit and also are used to replace the "C" batteries. In large equipment, such as some transmitters, a separate bias power supply is used. It may be a generator, a half-wave rectifier or a full-wave rectifier. The positive side of the power supply is connected to the cathode and the negative side is connected to the grid, just as is done with a "C" battery. In the illustration below, the positive terminal of the bleeder resistor is connected to ground and the negative terminal is connected to the grid through  $R_g$ . Since the cathode is grounded, the grid is negative with respect to the cathode.

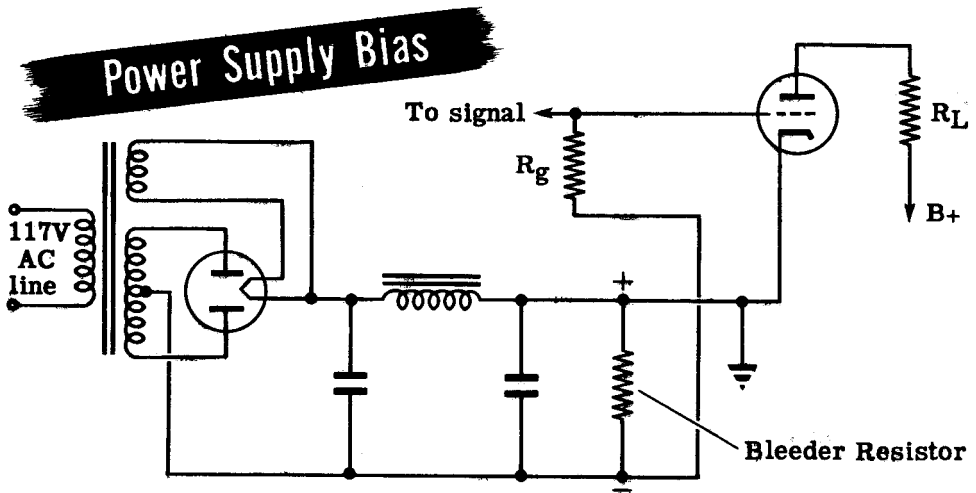

## Power Supply Bias-Generator Type

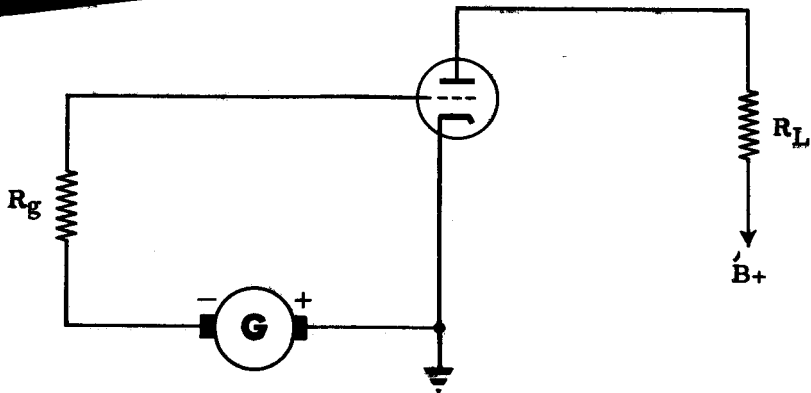

## THE TRIODE AMPLIFIER

### B+ Power Supply Bias

A negative and a positive voltage with respect to ground can be obtained from the same power supply. This is done by connecting two resistors in series across the power supply and grounding the junction of these resistors. A single tapped bleeder resistor can be used in place of the two resistors in series. The resistance to ground from the negative terminal is much smaller than the resistance from the positive terminal to ground. Therefore, the voltage across the positive portion of the bleeder will be greater than that across the negative portion. In other words, this circuit provides a large positive voltage with respect to ground which is used as the B+ plate supply voltage, and a small negative voltage with respect to ground which is used as grid bias voltage. The cathode is connected to ground, the plate is connected to the positive terminal of the bleeder through  $R_L$ , and the grid is connected to the negative terminal of the bleeder through  $R_g$ . Therefore, the grid is made negative and the plate is made positive, with respect to the cathode.

## *Negative Bias AND Positive Plate Voltage*

### FROM THE SAME POWER SUPPLY

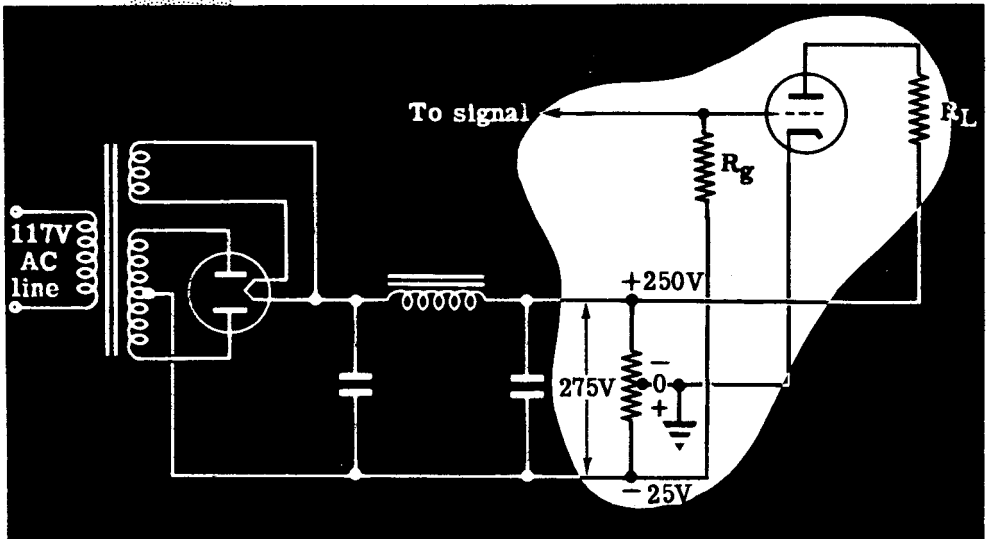



## THE TRIODE AMPLIFIER

### Cathode Bias

Of all bias systems, cathode bias is the most widely used. Cathode bias is obtained by connecting a resistor in series with the tube from B- or ground to the cathode.

In order to understand how this system works, it will be necessary for you to recall three points

1. If current flows through a resistor an IR drop will be produced.
2. The end of the resistor toward which the current is flowing is the most positive (+).
3. The purpose of bias is to keep the grid negative with respect to the cathode.

Look at the illustration below. Notice that a resistor ( $R_k$ ) has been placed in the cathode circuit of the vacuum tube, between cathode and ground. All the current that flows through the tube must flow up from B- through the cathode resistor. This produces an IR drop across the cathode resistor, making the cathode positive with respect to ground. Since the grid is connected to ground through  $R_g$  and ground is negative with respect to the cathode, the grid is also negative with respect to the cathode.

## CATHODE BIAS

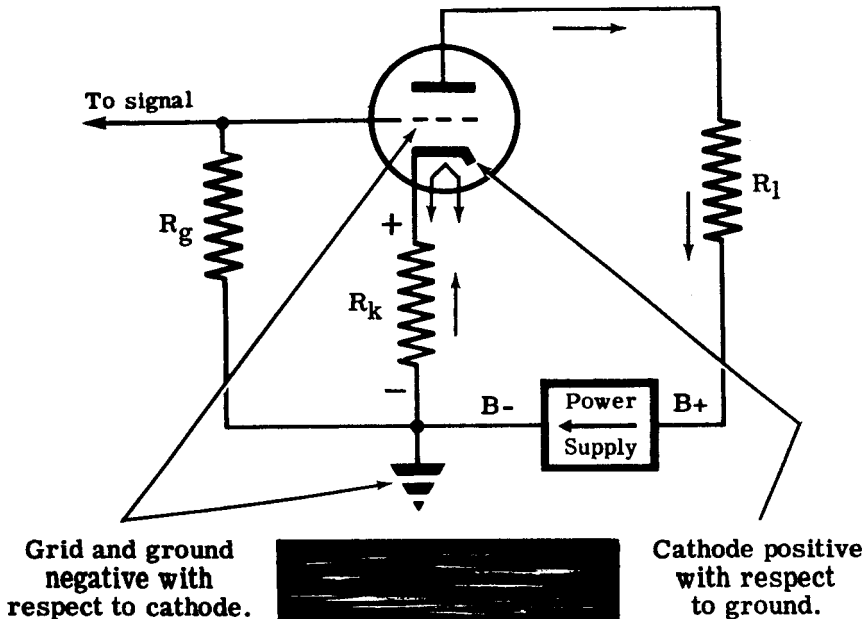

## THE TRIODE AMPLIFIER

### Cathode Resistor

Determining the size of the cathode resistor ( $R_k$ ) is merely an arithmetic problem. Suppose that a tube requires a bias of -6 volts for proper operation and a plate current of 4 ma. flows with this bias. The 6-volt bias is produced by 4 ma. flowing through the cathode resistor. Using Ohm's law—

$$R_k = \frac{E}{I} = \frac{6}{.004} = 1500 \text{ ohms}$$

To determine the size of the cathode resistor for a triode, divide the required bias voltage by the plate current.

DETERMINING THE SIZE OF  
THE CATHODE RESISTOR  
FOR A TRIODE

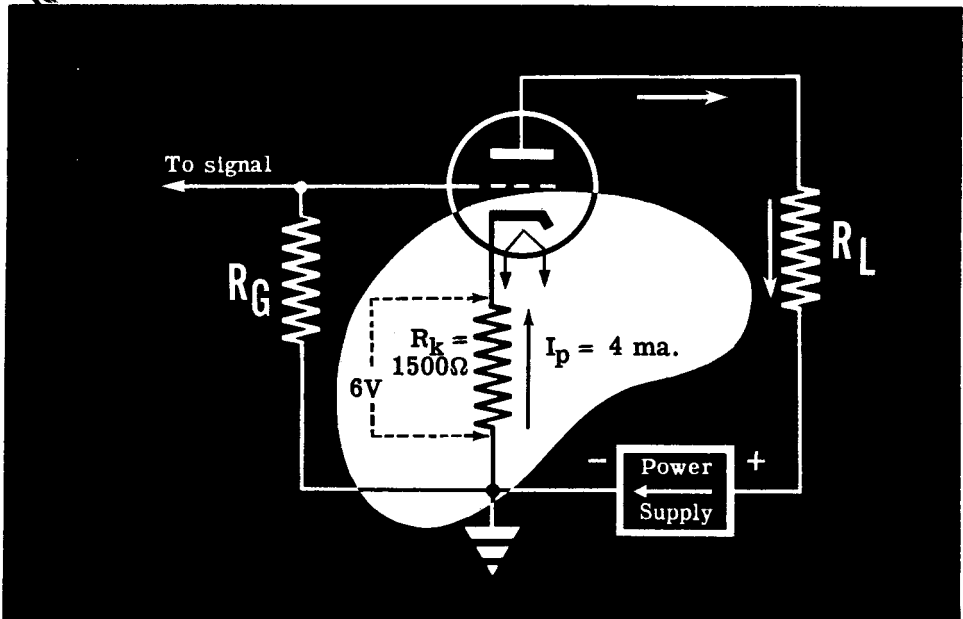
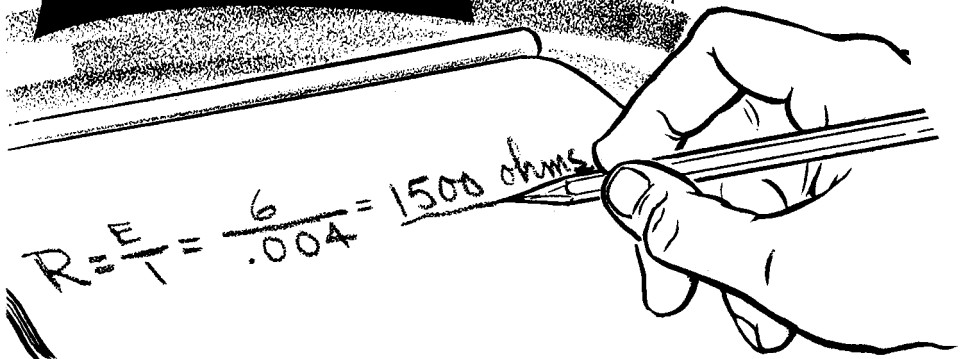

## THE TRIODE AMPLIFIER

### Cathode Resistor (continued)

In a triode, the only current that flows from the cathode of the tube is the plate current. This is not the case in the tetrode or pentode. Tetrodes and pentodes have a screen grid which has a positive voltage applied to it and attracts electrons from the cathode. Since all the current that flows through the tetrode and pentode must come from the cathode, the total cathode current is:

$$\text{PLATE CURRENT} + \text{SCREEN CURRENT} = \text{CATHODE CURRENT}$$

If a pentode, for example, has a plate current ( $I_p$ ) of 6 ma. and a screen current ( $I_{sg}$ ) of 2 ma., the cathode current would be 8 ma. If the required bias is 4 volts, using Ohm's law the value of  $R_k$  can be calculated—

$$R_k = \frac{E}{I} = \frac{4}{.008} = 500 \text{ ohms}$$

You will learn more about the construction, use and operation of tetrodes and pentodes in a later topic.

### DETERMINING THE SIZE OF THE CATHODE RESISTOR FOR A PENTODE OR TETRODE

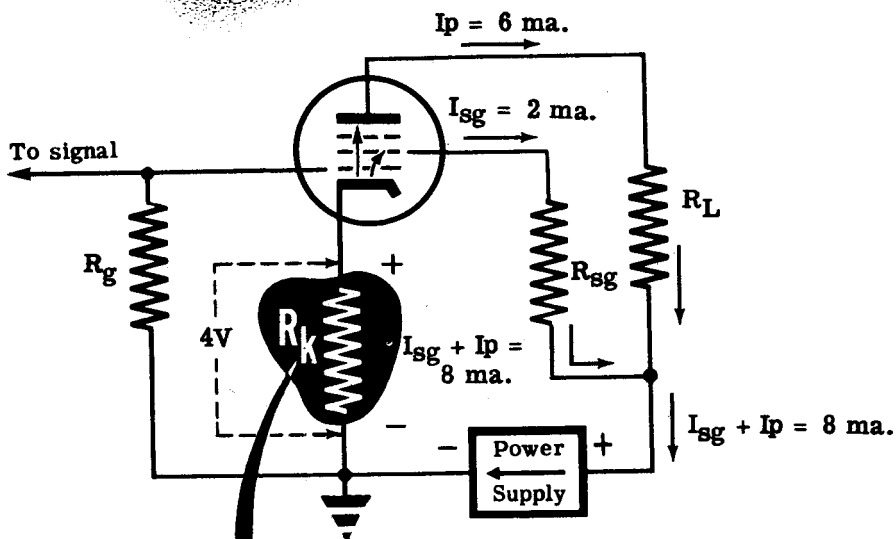

$$R_k = \frac{E}{I} = \frac{4}{.008} = 500 \text{ ohms}$$

$$R_k = 500 \text{ ohms}$$

# THE TRIODE AMPLIFIER

## Cathode Bypass Capacitor

A cathode bias resistor usually has a capacitor connected in parallel with it. This capacitor is called a bypass capacitor and its purpose is to keep the voltage across the cathode resistor at a constant value.

Suppose we look at the operation of a triode using cathode bias with no bypass capacitor. If a signal is applied to grid, the plate current will vary in accordance with the signal. Since it is the plate current flow through the cathode resistor that produces the bias, and this current flow varies, the bias will also vary.

This varying bias reduces the signal voltage between grid and cathode. On the next sheet you will see how this signal reduction occurs.

TRIODE AMPLIFIER WITH A CATHODE BYPASS CAPACITOR

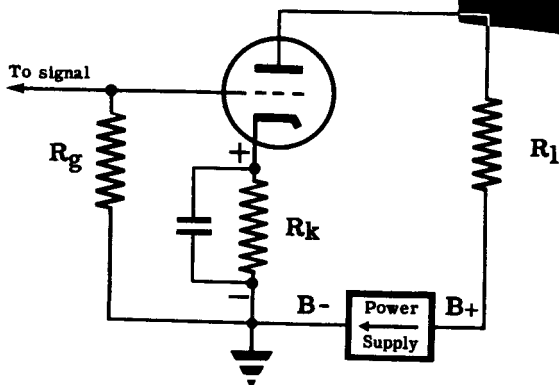

TRIODE AMPLIFIER WITHOUT A CATHODE BYPASS CAPACITOR

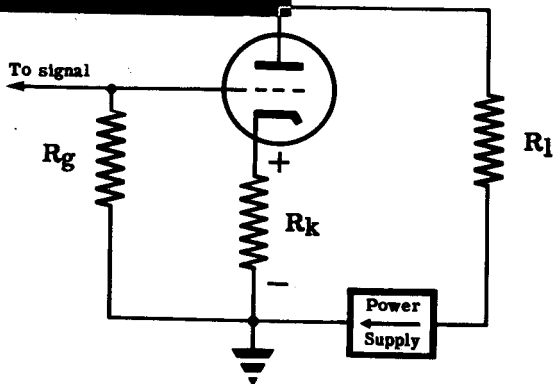

# THE TRIODE AMPLIFIER

## Cathode Bypass Capacitor (continued)

In the illustration below, an AC signal with a peak amplitude of 6V is applied to the grid of the triode. The triode has a cathode bias voltage of -8V with no signal applied. If the bias voltage remained constant, the signal would add to the bias during its negative half cycle,  $(8 + 6) = 14V$  negative, and it would subtract from the bias during the positive half cycle  $(8 - 6) = 2V$  negative.

With the grid to cathode voltage varying between -14V and -2V, the plate current will be minimum at -14V and maximum at -2V. In this case, assume that the plate current variation produces a voltage variation of 2 volts across the cathode resistor. Observe that the cathode voltage increases (becomes more negative) when the plate current increases and therefore the cathode bias voltage increases when the signal is reducing it (making it less negative). The voltage variation across the cathode resistor is 180 degrees out of phase with the input signal so that the two voltages (signal and cathode voltage variation) subtract from one another to produce an effective voltage variation of  $(6 - 2) = 4$  volts between grid and cathode.

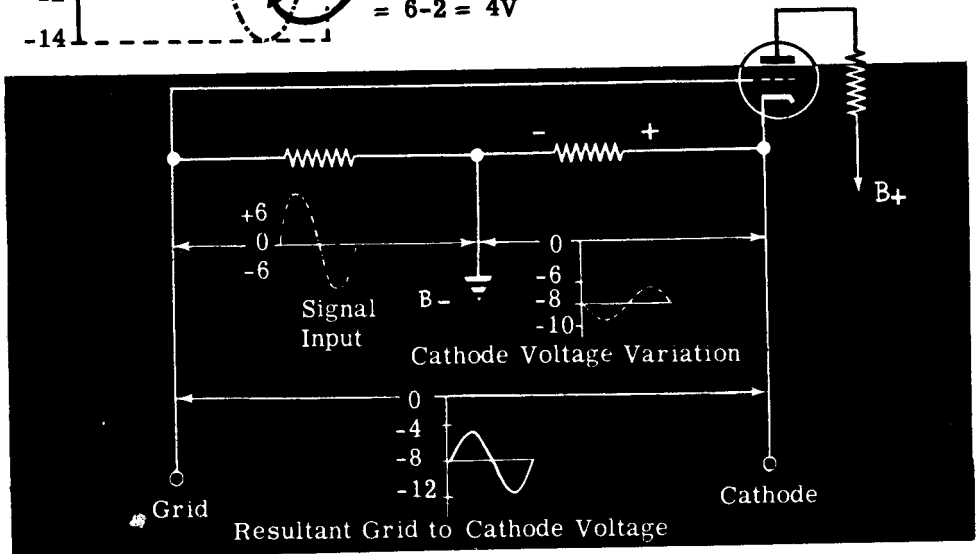
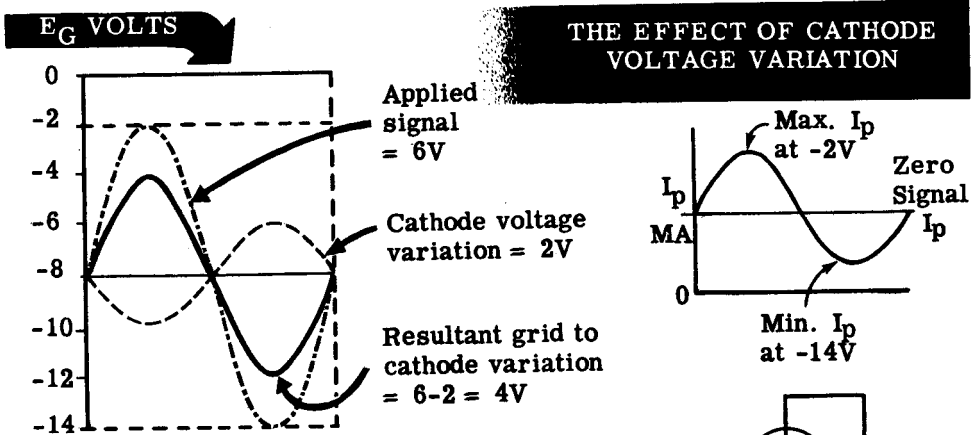

## THE TRIODE AMPLIFIER

### Cathode Bypass Capacitor (continued)

In other words, the cathode voltage variations cancelled 2 volts of signal. This effect is called degeneration. To eliminate the effect of degeneration, a cathode bypass capacitor is placed in parallel with the cathode resistor. If the proper capacitance is chosen, its capacitive reactance (found by using the formula you learned in Basic Electricity— $X_c = \frac{1}{2\pi fC}$ ) will be about one tenth the size of the resistor. Since a capacitor will only pass a continuously changing (AC) current, the steady (DC) component of current flows through the resistor and the varying component of current flows through the bypass capacitor. The resistor is virtually shorted out by the low reactance of the capacitor when a current variation occurs. The only current through the resistor is a steady one. Therefore, the voltage across the resistor will remain constant when a signal is applied to the grid and no signal cancellation will take place.

Here is an example of the method used to determine the size of the bypass capacitor. Suppose you had the circuit shown below.

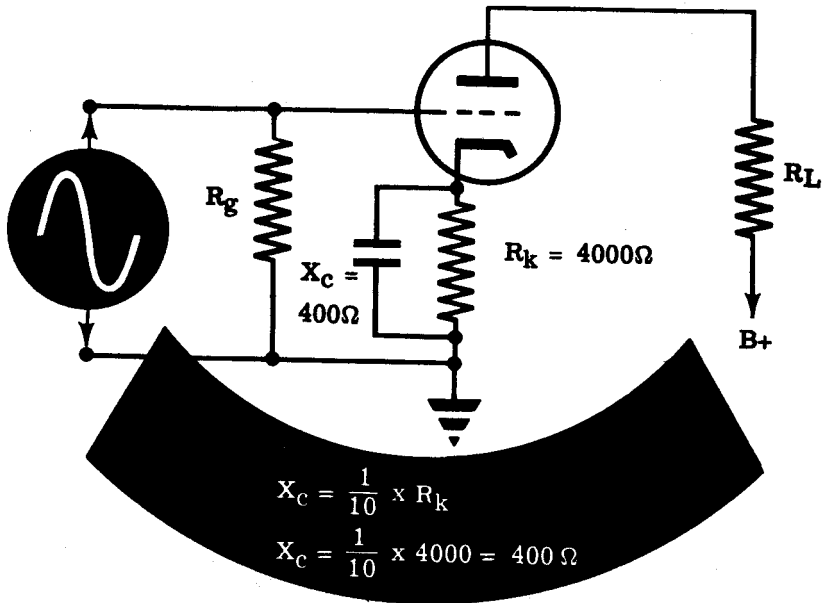

Since  $X_c = \frac{1}{2\pi fC}$ , the capacity of the bypass condenser can be found by using the formula  $C = \frac{1}{2\pi fX_c}$ , where  $f$  is the lowest frequency signal to be amplified. Suppose  $f$  is 60 cps and  $X_c$  is  $400\Omega$  as shown above, then  $C$  will be—

$$\frac{1}{6.28 \times 60 \times 400} \approx 6.6 \text{ mfd.}$$

Since capacitors are not made with a value of 6.6 mfd., a 10 mfd. capacitor would be used.

# THE TRIODE AMPLIFIER

## Review of Triode Amplifier Operation

**GRID BIAS** — The amount of grid-bias voltage determines whether an amplifier is operating Class A, Class B or Class C. In Class A the bias is less than cut-off; in Class B bias is at or near cut-off; in Class C bias is much less than cut-off.

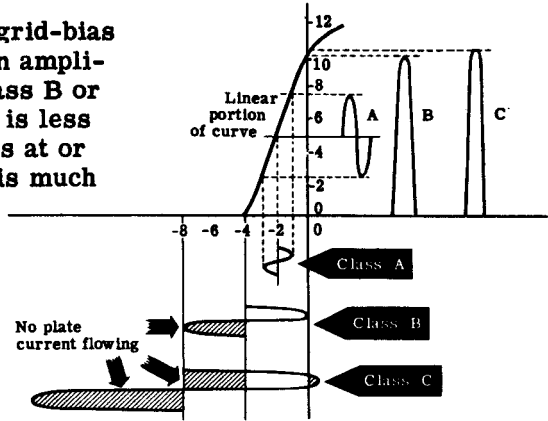

**B+ POWER SUPPLY BIAS** — A single power supply can be used to supply a positive voltage for B+ and a negative voltage for grid bias.

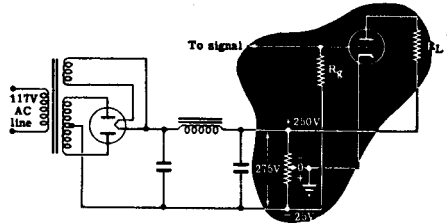

**CATHODE BIAS** — A cathode bias resistor in parallel with a cathode bypass capacitor in the cathode circuit provide the most widely used system of biasing.

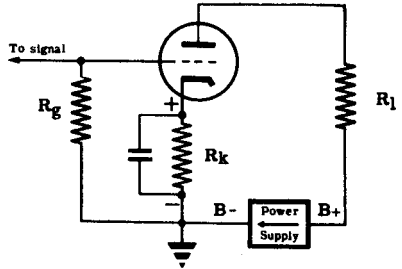

**TRIODE AMPLIFIER OPERATION** — The variation in voltage output (plate voltage) of a triode, used as an amplifier, may be ten or more times larger than the variation in the grid voltage (AC signal).

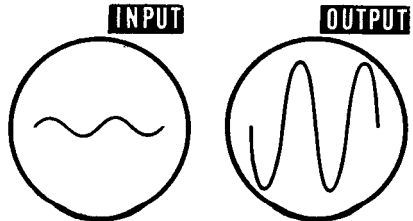

## THE TETRODE AND THE PENTODE

### Why the Tetrode Was Developed

A capacitor, as you know, is nothing more than two pieces of metal separated by a dielectric (insulator). In a vacuum tube each pair of elements acts as if it were a small capacitor. In a triode there are three such capacitors—one consisting of the grid and plate, one of the grid and cathode and the third of the plate and cathode. These are called the "interelectrode capacitances" and each one has a capacitance of only a few micromicrofarads.

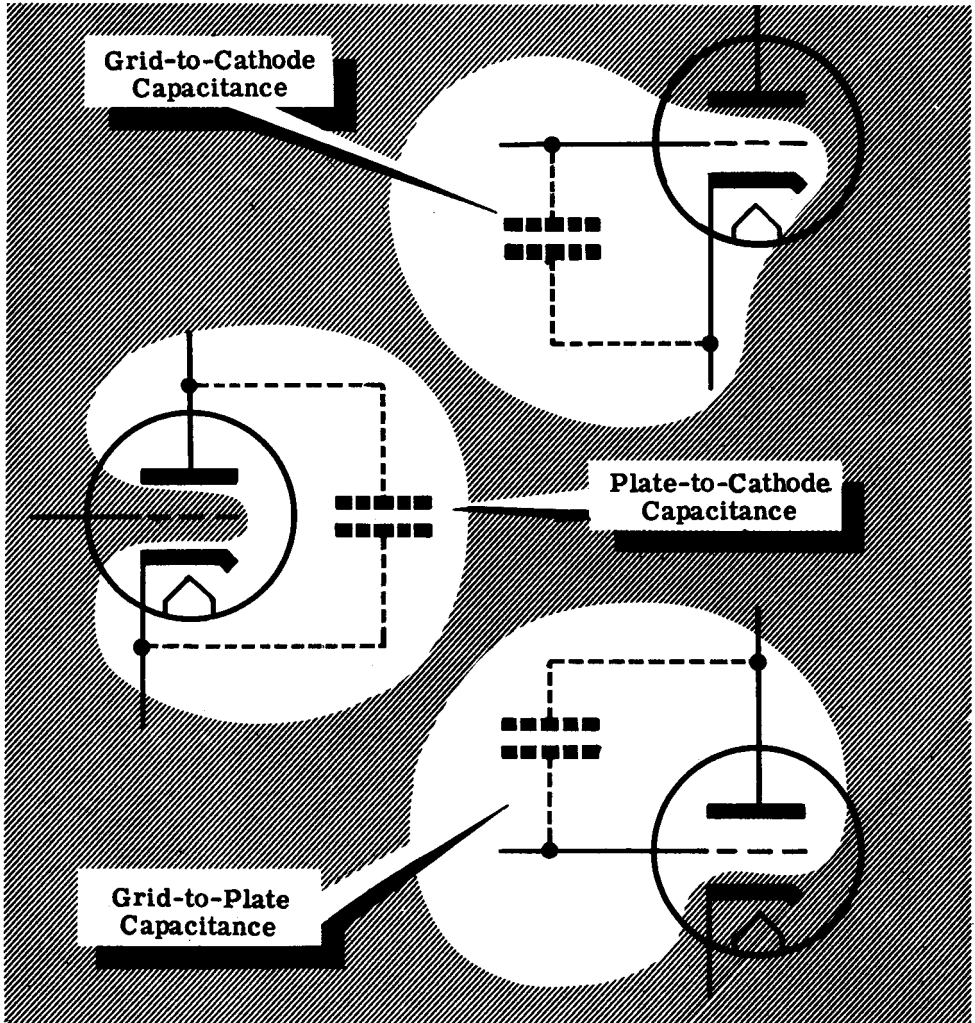

The grid-to-plate capacitance is the one which causes most of the trouble. At high frequencies it produces undesirable effects which may prevent the tube from amplifying properly. This will be explained later.

The tetrode was developed to reduce the interelectrode capacitance between the control grid and the plate.



# THE TETRODE AND THE PENTODE

## The Screen Grid

In the tetrode a second grid is placed between the control grid and the plate. Now there are two small capacitors in series between the plate and the grid and, of course, the total grid-to-plate capacitance is reduced. This second grid, called the "screen grid," has the effect of shielding the plate from the first grid and allows the tetrode to be used at higher frequencies than the triode could be used.

Normally, the screen grid has a high positive voltage and attracts electrons from the space charge just as the plate did in the triode. However, because the screen grid is a spirally-wound thin wire, most of the electrons pass right through it and end up at the plate. The screen draws only a little current.

# TETRODE

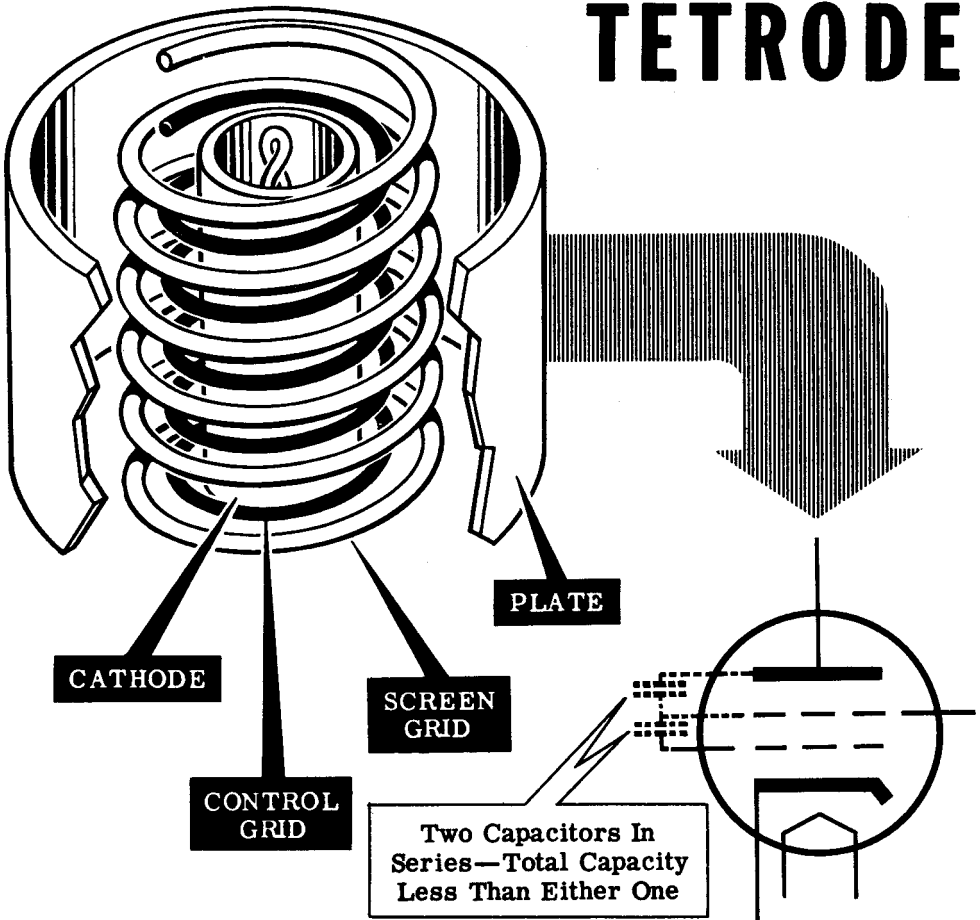

The plate is usually kept at a higher voltage than the screen and the plate circuit does not differ much from that which is used with triodes. In the tetrode, however, the plate voltage has less effect on the tube current than it did in the triode.

## THE TETRODE AND THE PENTODE

### Secondary Emission in the Tetrode

In any tube—diode, triode or tetrode—when one electron strikes the plate, it knocks several electrons out. Known as "secondary emission," this happens because the electrons are hitting the plate at high speed which becomes ever greater as the plate voltage is raised.

In the triode, secondary emission is not important since the plate is the most positive element in the tube and, therefore, attracts all the electrons that have been knocked out of it. In the tetrode, however, some of these secondary electrons (those which have been freed from the plate as a result of secondary emission) are attracted to the screen. Any flow of secondary electrons from the plate to the screen adds to the screen current and subtracts from the plate current.

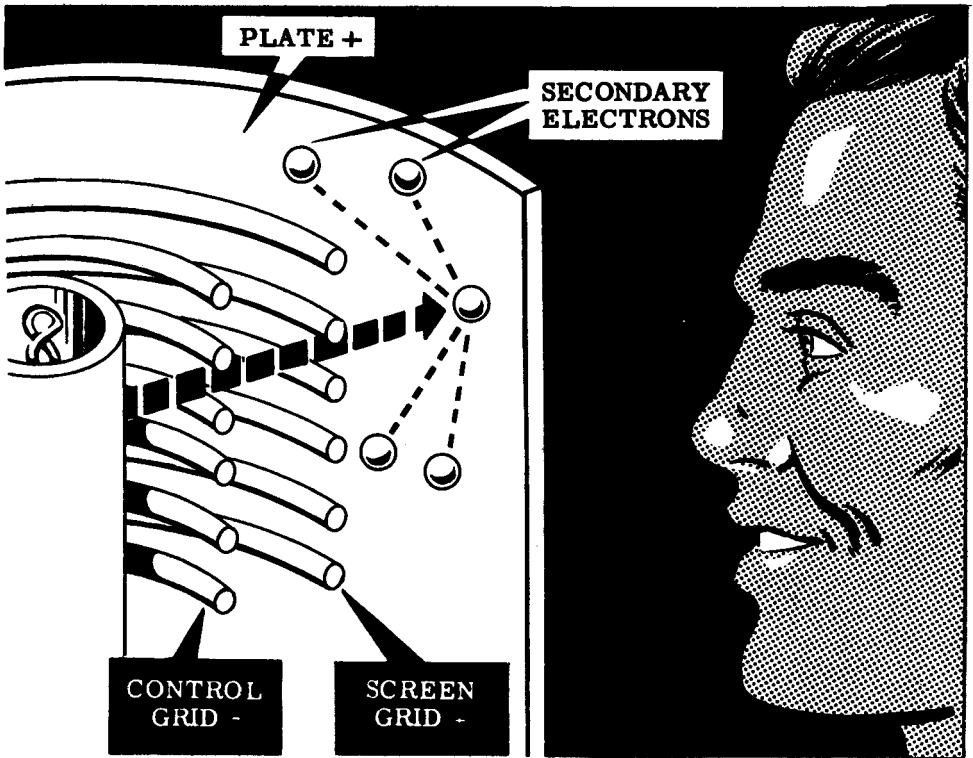

### *Cutaway Section* -- OF A TETRODE

The number of secondary electrons which do not return to the plate depends upon the difference between the plate and the screen voltages. If the plate voltage is much higher than the screen's, all the secondary electrons will return to the plate and there will be no decrease in plate current. If the plate voltage is much lower than the screen's, fewer secondary electrons will be emitted, but all of these will be attracted to the screen.

## THE TETRODE AND THE PENTODE

### Static Characteristics of the Tetrode

The tetrode is rarely used today, and you are being told about this tube only because it is a "stepping stone" between the triode and the pentode. If static characteristics of a tetrode were taken with varying plate voltage but constant control and screen grid voltages, you would get a curve resembling the one in the diagram.

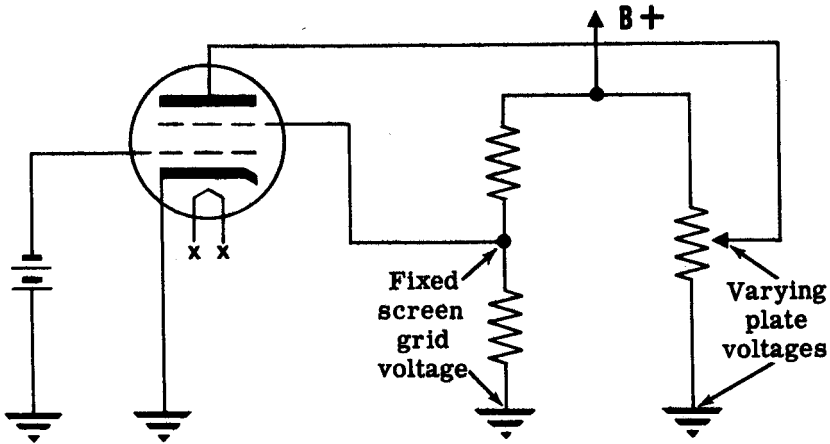

Notice that at high plate voltages above 300V, the plate current does not change when the plate voltage is increased. This is because the screen shields the plate from the space charge at the cathode which causes the screen to exert a greater control over plate current than the plate itself.

At about 100 volts, an increase in plate voltage causes a decrease in plate current because more electrons are knocked out of the plate by secondary emission. As long as the plate voltage is below the screen voltage, almost all the secondary electrons go to the screen.

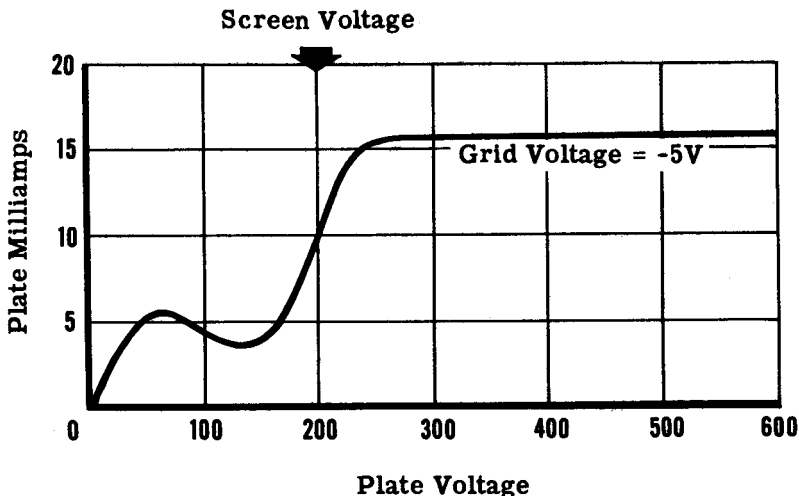

# THE TETRODE AND THE PENTODE

## Normal Operation of the Tetrode

Cathode bias in the tetrode is obtained in the same way as in the triode, except that in the tetrode the current flowing through the cathode resistor is the sum of the screen and plate currents.

The control grid voltage varies according to the input signal and produces variations in the plate current. Therefore the plate current the screen grid current vary with the control grid voltage. Screen grid voltage variation is prevented by connecting a screen bypass capacitor to ground. This keeps the screen at a fixed DC level and the tube current will be varied only by varying the control grid voltage.

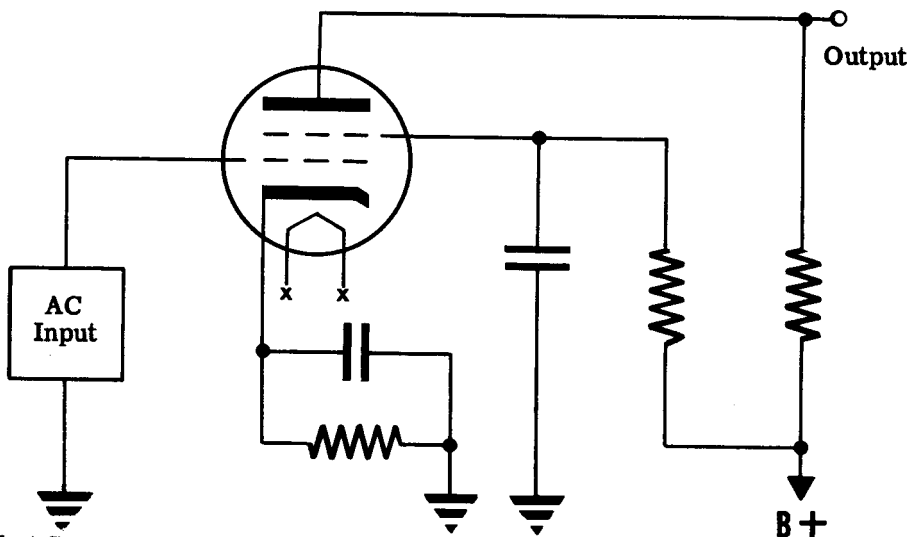

With AC on the control grid of the tube, the plate voltage will vary because of the drop in the load resistor just as in the triode. When the tetrode is used for getting large amplifications, the plate voltage varies over a wide range and, if it drops below the screen grid voltage, secondary emission effects cause distortion in the output.

To prevent this, the plate voltage would have to be very large to keep the plate at a higher potential than the screen regardless of the amount of voltage variation at the plate.

This—the requirement of an abnormally high B+—is the main disadvantage of using a tetrode. You will see how the pentode overcomes this disadvantage.

**DISTORTED OUTPUT OF  
TETRODE WITH "LOW"  
PLATE VOLTAGE SUPPLY**

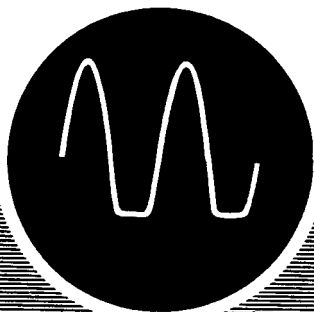

## THE TETRODE AND THE PENTODE

### Eliminating the Effects of Secondary Emission

You have seen that the main disadvantage of the tetrode is the need for a high plate voltage to prevent distortion in its output due to the effect of secondary emission.

The pentode is designed to overcome this undesirable feature of the tetrode by eliminating the flow of secondary electrons between the plate and the screen grid. This is accomplished by the inclusion of a third grid, the suppressor grid, between the plate and the screen grid.

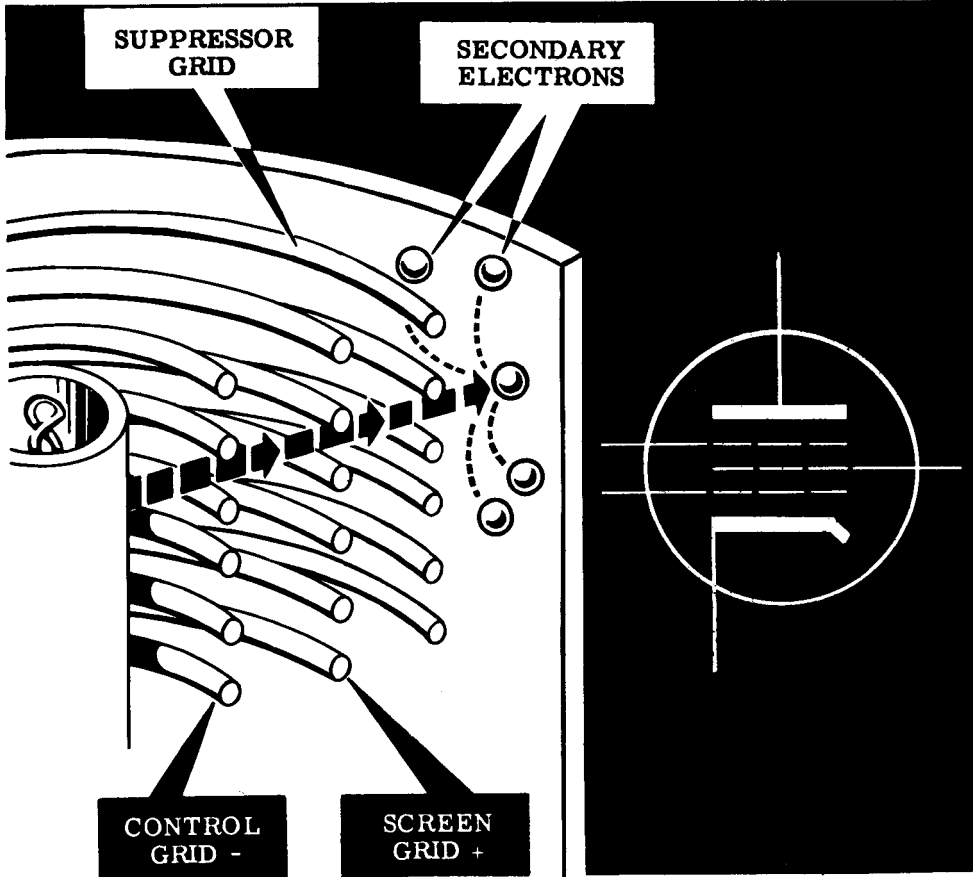

### *Cutaway Section - - OF A PENTODE*

The suppressor grid is usually kept at cathode potential so that it is always very negative with respect to the plate. Therefore, any electron that is in the region between the suppressor and the plate (such as a secondary electron) is attracted back to the plate and prevented from getting through the suppressor to the screen. As a result of this arrangement, secondary emission does not affect the operation of the pentode.

# THE TETRODE AND THE PENTODE

## How the Pentode Works

You remember that in a triode a decrease of the negative grid voltage produced an increase in the current and a decrease in the plate voltage. The plate voltage change was more than the change in grid voltage. We called the ratio of plate voltage change to grid voltage change "amplification."

You remember too that the plate voltage in a triode also affects the current flow. The decrease in plate voltage has a tendency to decrease the current. The grid is trying to increase the current. It is clear, then, that the decrease in plate voltage is opposing the effect of the grid voltage decrease.

If the grid has 20 times as much control of the current as the plate has, the limit of amplification would be 20. When such an amplification is reached, the plate voltage changes would be 20 times as large as the grid voltage changes and, theoretically, there would be no change in the current. Thus the amplification is limited by the fact that the plate has some effect on the current.

In a pentode, neither the suppressor nor the plate voltage affect the amount of current drawn from the space charge surrounding the cathode since the screen grid shields both of these elements from the cathode. As in the tetrode, the pentode's screen voltage is fixed at some positive value and, therefore, only the variations of control grid voltage cause changes in plate current.

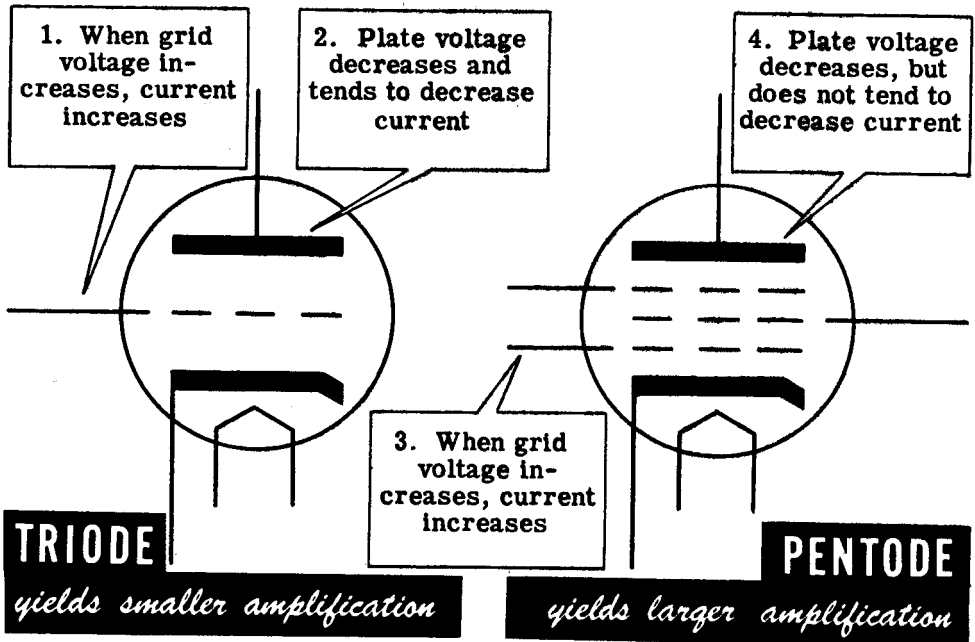

In the pentode the plate voltage can vary considerably with almost no effect on the current and, therefore, with no cancellation of the grid's control of the plate current. As a result, the amplification of a pentode is many times greater than that of a triode.

# THE TETRODE AND THE PENTODE

## A Typical Pentode Tube

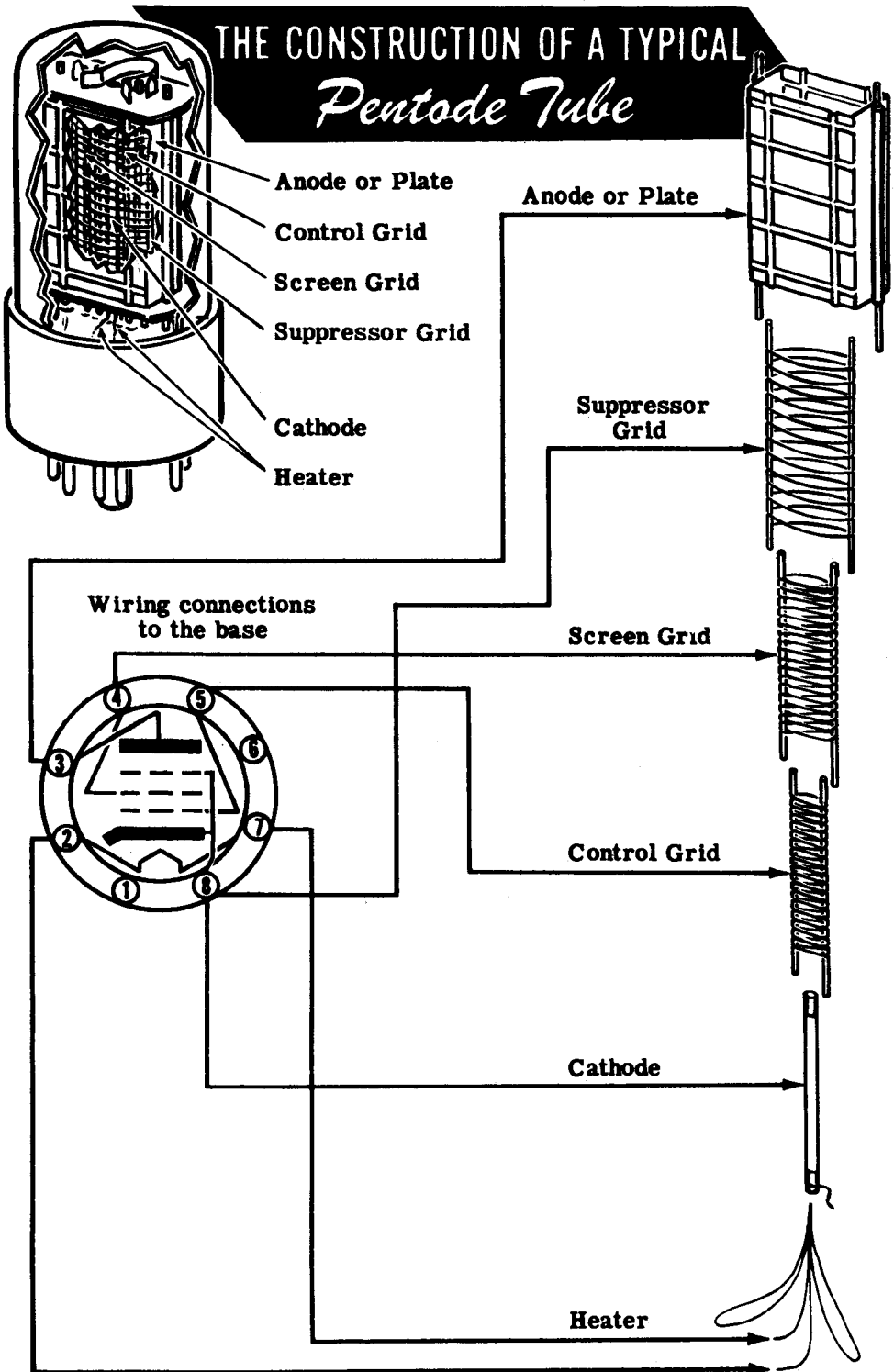

# THE TETRODE AND THE PENTODE

## The Beam Power Tube

You have learned from your study of the pentode that the suppressor grid reduces the effects of secondary emission. Instead of using the suppressor grid to control secondary emission from the plate, the same effect can be obtained by arranging the tube elements in such a way as to produce a negative charge near the plate. The action of this space charge is to repel any secondary emitted electrons back to the plate just as the suppressor does in the pentode.

The figure below shows the internal structure of a typical beam power tube such as the 6L6, 50L6, 6V6 and others. You see that this tube has a cathode, control grid, screen grid and two new parts—the beam-forming plates which are connected to the cathode. Each beam-forming plate extends about one-fourth the distance around the grids of the tube and prevents any electrons from reaching the plate except through the openings between the beam-forming plates. This tends to concentrate the electron stream into a small area and thereby form an electron beam.

The openings in the grids are arranged in such a way that the electrons pass between the grid wires in layers or sheets. After passing the screen grid, these electrons combine to form a concentration of electrons, or space charge, near the plate. It is this space charge that does the same job as the suppressor in the pentode.

The beam power tube has an advantage over the pentode in that a greater power output can be obtained for a given amount of cathode emission.

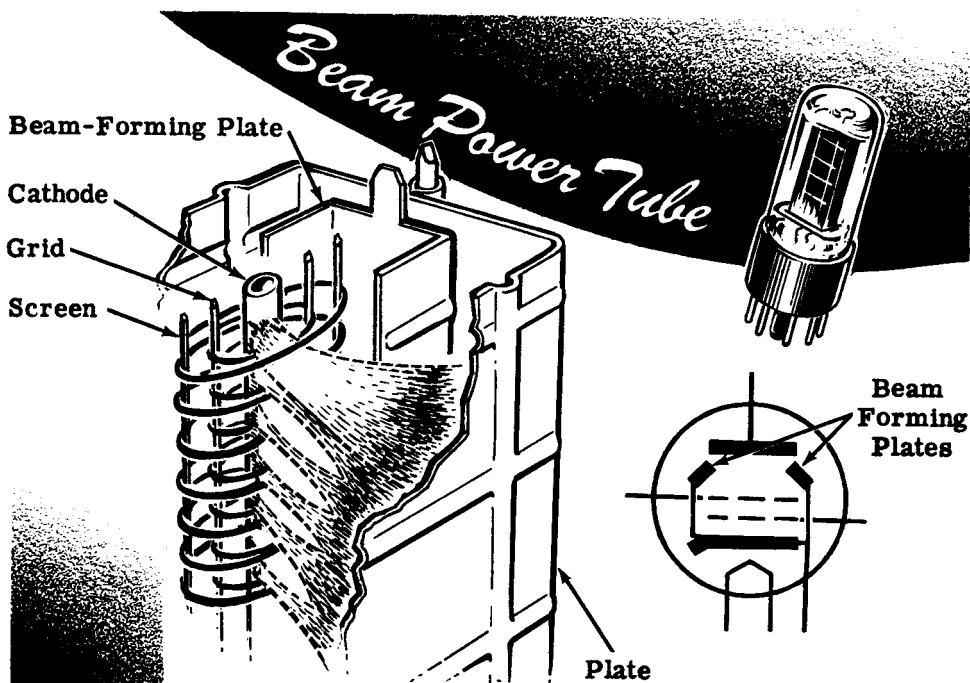



# THE TETRODE AND THE PENTODE

## The Beam Power Tube (continued)

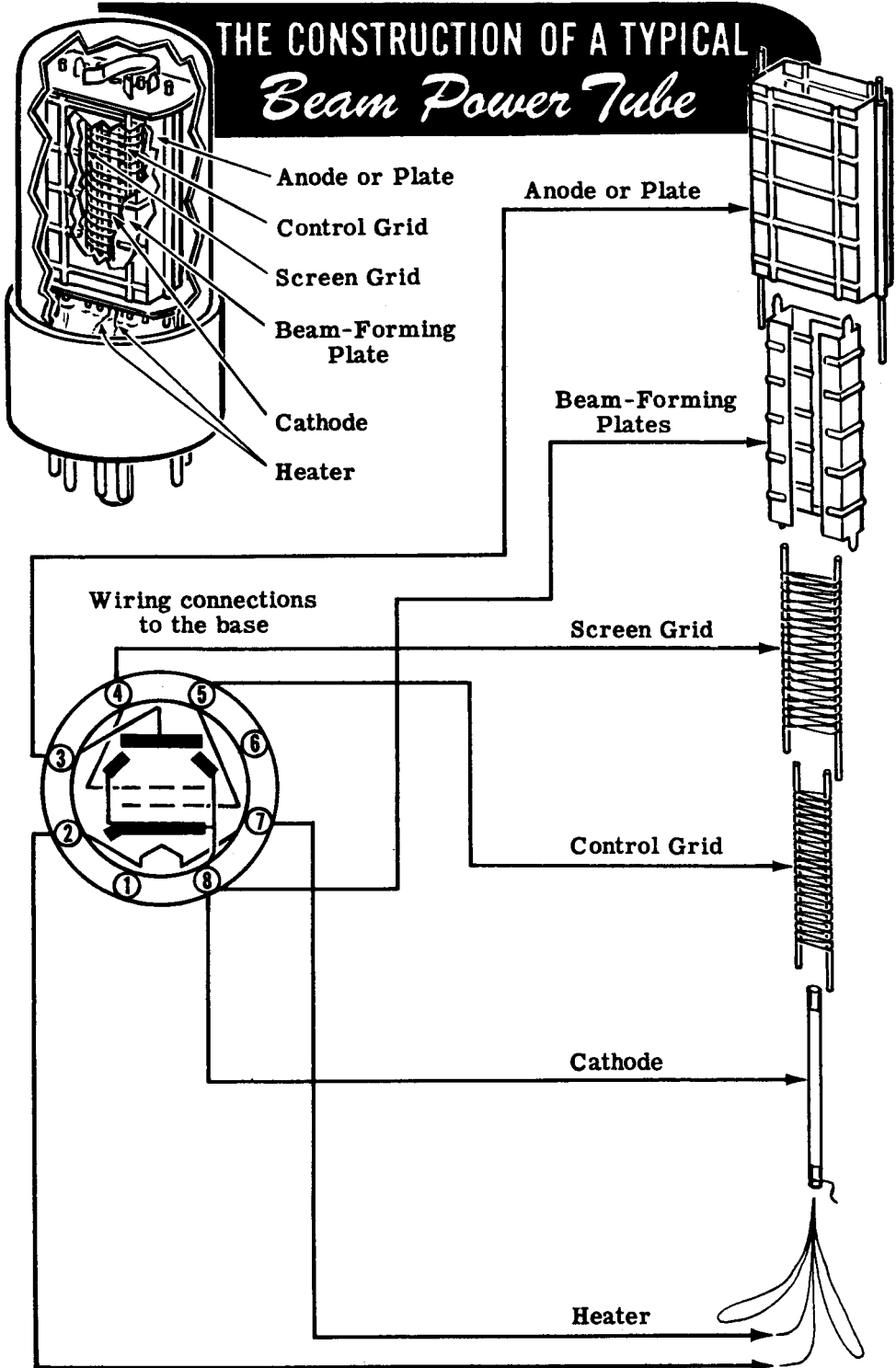

# THE TETRODE AND THE PENTODE

## Summary of Pentode Operation

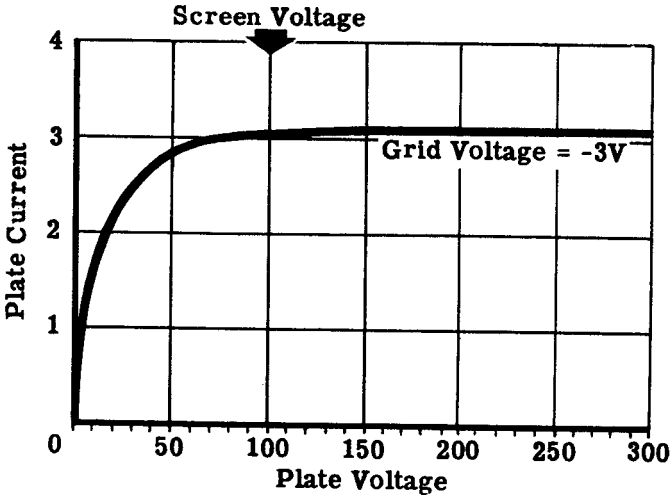

Curve No. 1: Over a wide range of plate voltages, the pentode plate current does not vary. But this is not saturation; in the next curve you will see that it is possible to draw more current than this. The reason the current doesn't vary over this range of values is that the screen shields the plate from the cathode's space charge.

At low plate voltages, however, the plate current does vary. Although the total tube current remains the same, many more electrons are attracted to the screen, which is now more positive than the plate is.

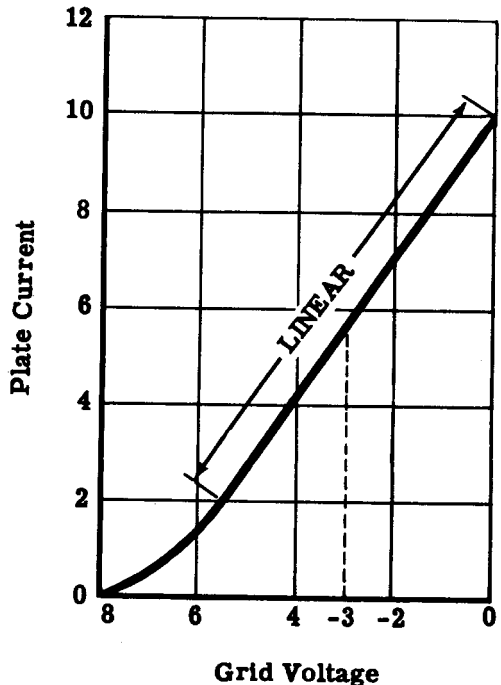

Curve No. 2: Here, you see that the control grid in a pentode controls current in the same way as it did in a triode. Normal grid bias for this particular pentode is about -3 volts.

The fact that the current rises considerably above 3 ma. in this test shows that 3 ma. is not the limit of cathode emission. Therefore, the flattened portion you saw in the first curve could not have been saturation.

## THE TETRODE AND THE PENTODE

### Summary of Pentode Operation (continued)

Curves No. 3 and 4: With the same value of load resistor in each, you can obtain larger amplifications with the pentode than with the triode.

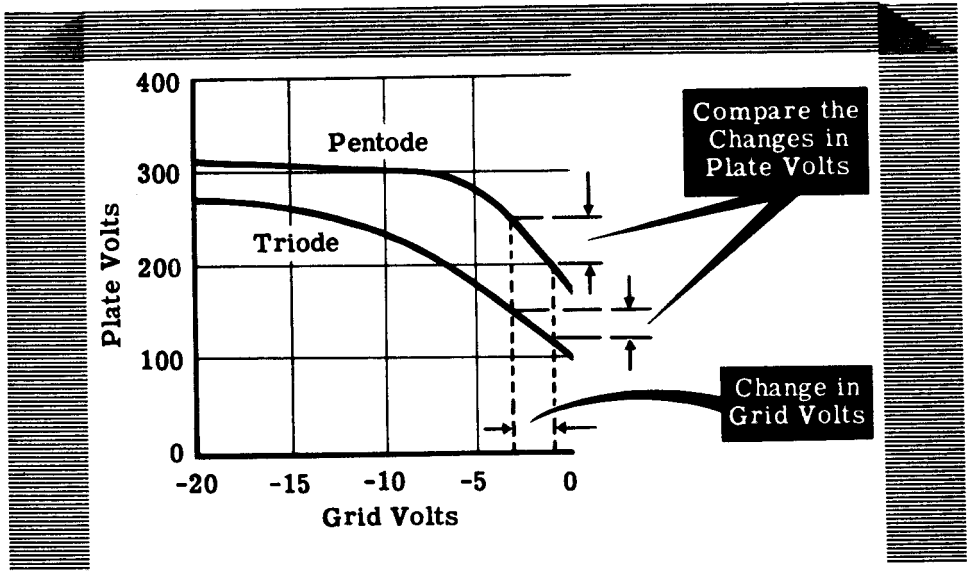

With a larger load resistor in the pentode circuit, larger amplification is obtained. This happens because the grid voltage, and only the grid voltage, can produce a change of current. This current will flow through the load resistor—the larger the resistor, the larger the voltage change.

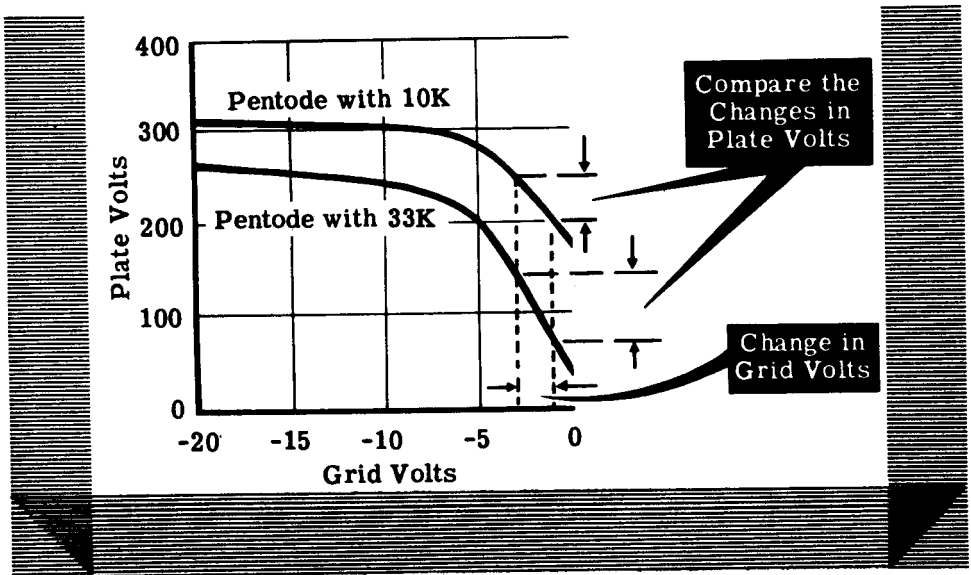

# THE TETRODE AND THE PENTODE

## Review of Tetrodes and Pentodes

**THE TETRODE** — A tube having a screen grid to reduce plate-to-control grid capacitance. It is rarely used today, but was a step in the development of the pentode.

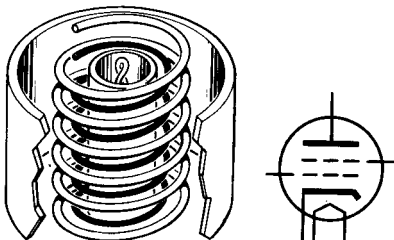

**THE PENTODE** — A tube which uses a suppressor grid between the screen grid and plate to reduce the effect of secondary emission. It has greater amplification than the triode.

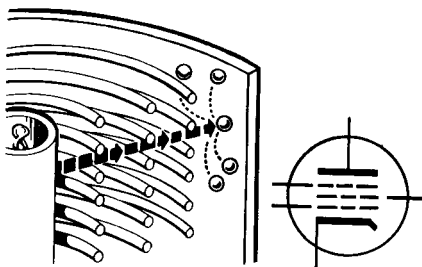

**THE BEAM POWER TUBE** — Tube using beam-forming plates instead of the suppressor to reduce the effects of secondary emission. Its power output is greater, for a given amount of cathode emission, than that of a pentode.

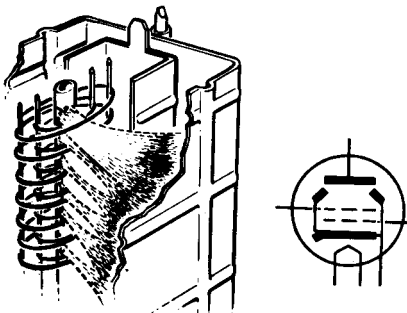

**PENTODE CIRCUIT** — A circuit providing proper operating voltages for control grid, screen grid and suppressor grid.

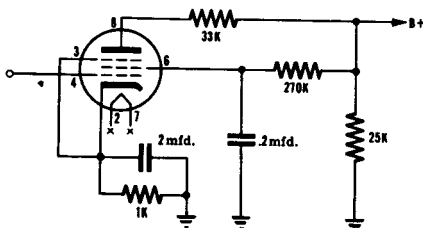

# THE SINGLE-STAGE AMPLIFIER

## A Typical Amplifier Stage

You are already familiar with the purposes of most of the components that will be used in this amplifier circuit. The 1-meg. resistor in the grid circuit is there to prevent any negative charge from accumulating on the grid. The 12K resistor and the 25-mfd. capacitor in the cathode circuit are the bias components. The 270K resistor in the plate circuit is the load resistor. The .01-mfd. capacitor and the 1-meg. resistor will be the RC coupling to the next stage of amplification.

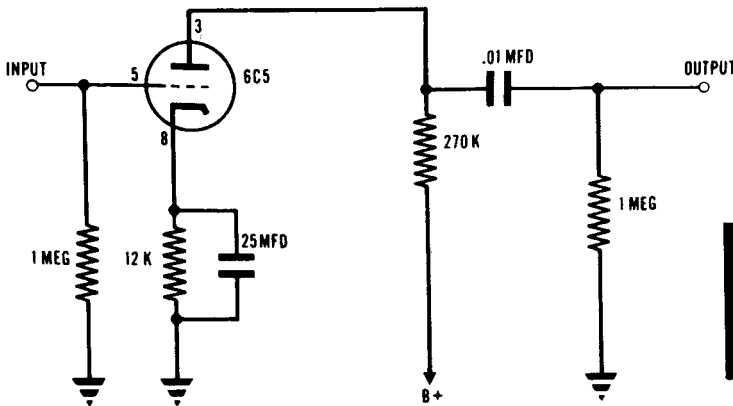

**TYPICAL  
AMPLIFIER  
STAGE**

The circuit shown below has two additional components. You will notice that the plate load resistor is connected to B+ through a 25K resistor. This resistor and the 8-mfd. capacitor make up a special filter circuit called a decoupling filter. If some form of undesired coupling exists between the various circuits of a multistage amplifier, we say that we have feedback. This feedback causes the amplifier to generate a low frequency audio signal which sounds like a motorboat when heard from the loudspeaker. It is the job of the decoupling filter to eliminate the feedback and the resultant motorboating.

## Typical Amplifier Stage with **DECOUPLING FILTER**

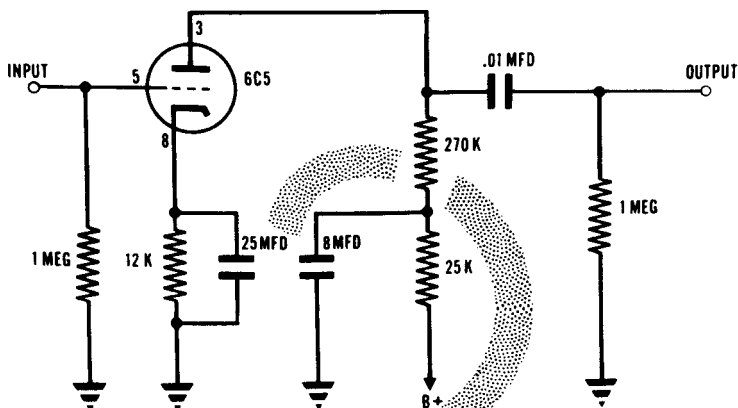

# THE SINGLE-STAGE AMPLIFIER

## The Decoupling Filter

Coupling may exist between circuits operating at the same frequency and having common impedance. If an amplifier contains several stages of amplification, all those stages will be supplied with plate voltage from a single source of DC power. The plate currents of all the amplifier tubes must flow through this power supply. Therefore, the internal resistance of the power supply (produced by the choke wire, internal tube resistance, etc.), will act as a common impedance for all the amplifier circuits.

When a signal is applied to the amplifier, the plate currents of all the tubes will vary in accordance with the signal. In addition to the DC flowing through the common power supply, we now have the AC components of all the plate currents flowing through the common impedance. Some of these currents will be in phase with each other and some will be 180 degrees out of phase. It is the currents which are in phase that cause the most trouble.

The in-phase currents add to one another and produce voltage variations across the common impedance which "feeds back" the variations from one stage to another. The overall effect of this is a sound in the loudspeaker which resembles the purring of an outboard motor. That is why this trouble in an amplifier is called "motorboating."

On the next sheet you will see how the decoupling filter eliminates feedback and motorboating.

## FEEDBACK IN A THREE STAGE AMPLIFIER

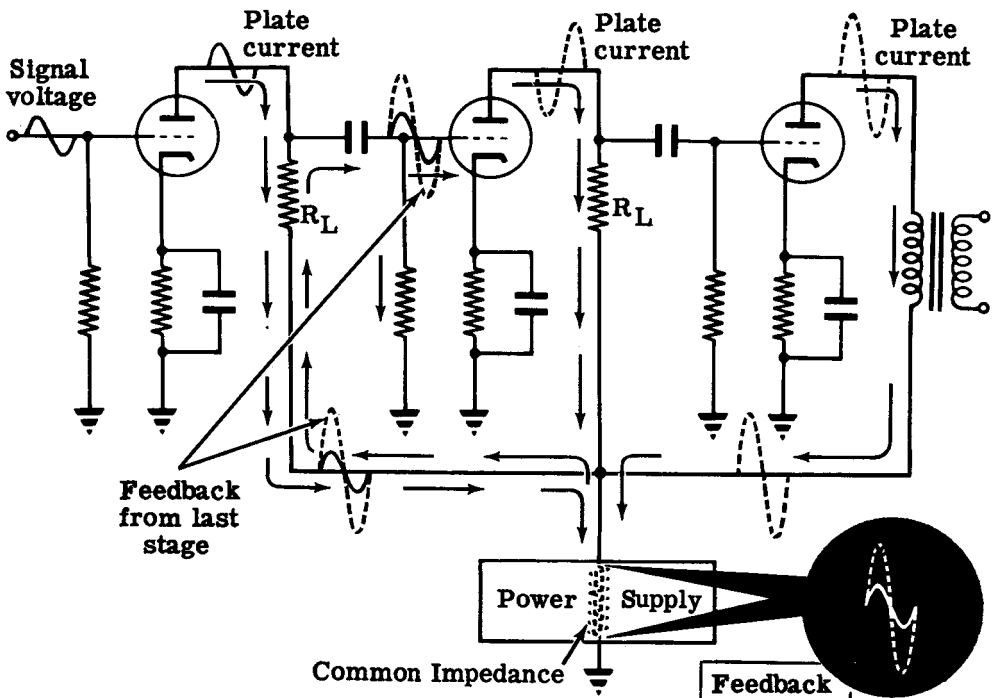

# THE SINGLE-STAGE AMPLIFIER

## The Decoupling Filter (continued)

If the AC components of plate current could be kept from flowing through the common impedance of the power supply, then the feedback that originates there would be eliminated. The decoupling filter's job is to provide a path of low reactance around the power supply and a path of high resistance to AC current flow through the power supply. Because of this very little AC current will flow through the power supply and its common impedance, thereby eliminating feedback.

The value of the decoupling capacitor must be high enough so that its reactance is much less than the total resistance of the decoupling resistor and the common impedance of the power supply. In an amplifier of the type shown, the value of the decoupling resistor is generally about one fifth the value of the plate load resistor  $R_L$ . The value of the decoupling capacitor varies from about 0.25 to 8 mfd.

The action of the decoupling filter is to isolate each stage from the power supply common impedance. The way the filter does this is shown below.

### *Decoupling Filters* ISOLATE AMPLIFIER STAGES AND ELIMINATE FEEDBACK

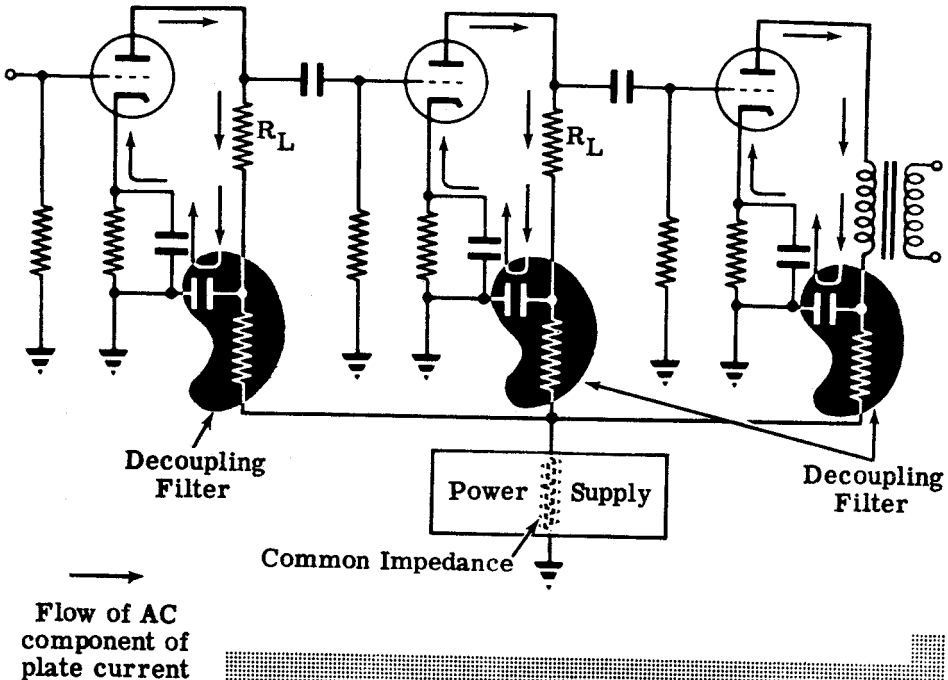

## THE TWO-STAGE RC COUPLED AMPLIFIER

### How to Increase Gain

If you need a voltage gain of 200 or less in an amplifier, one tube would be enough. However, very often a gain of 10,000 or 100,000 or even higher is required, and there is no way to make a single vacuum tube give you that much amplification. In order to increase the amplification, several tubes are needed.

These tubes are connected so that the voltage change from the plate of one amplifier tube is fed into the grid of a second tube; the voltage change from the plate of the second tube is fed into the grid of a third tube and so forth. If the amplification of each tube is 50, the signal input to the second tube will be 50 times greater than the signal fed into the first. The output of the second tube will be 50 times greater than its input or 2,500 times greater than the original signal. The third tube will amplify the output of the second tube 50 times so that its output is  $50 \times 2,500$  times larger than the input to the first tube. Thus, the amplifier using three tubes, each with a gain of 50, has an overall gain of 125,000!

$$50 \times 50 \times 50 = 125,000$$

If the voltage change applied to the input of this amplifier is one ten-thousandth of a volt, the voltage change on the plate of the third tube will be twelve and a half volts.

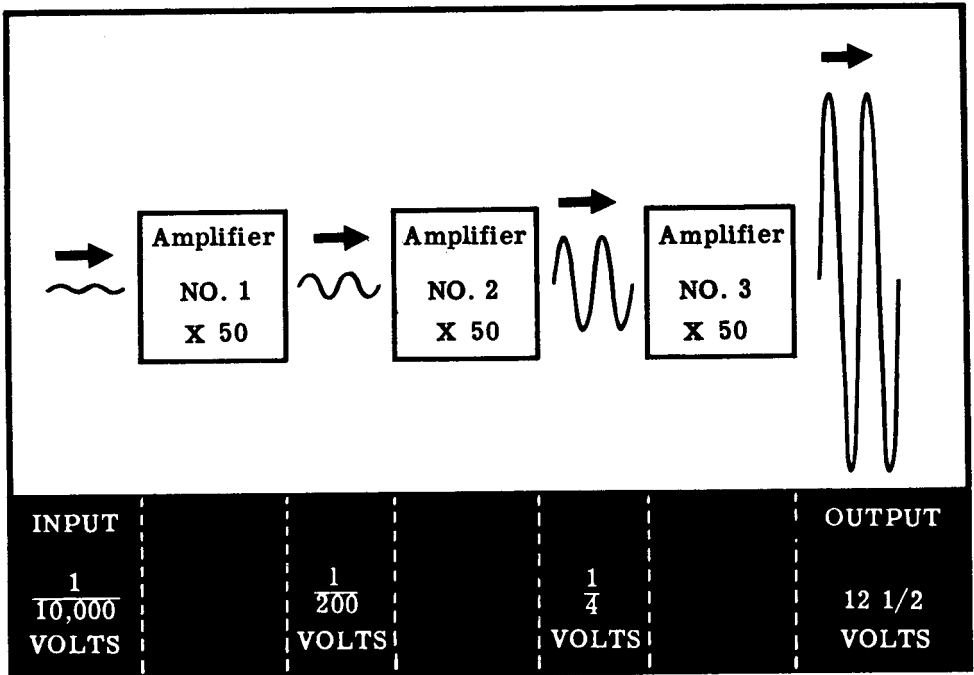

Since nearly all amplifiers require more amplification (gain) than can be achieved with only one tube, multi-stage amplifiers of this type are very common in all types of electronic equipment.



# THE TWO-STAGE RC COUPLED AMPLIFIER

## Coupling of Amplifier Stages

When several tubes are used in an amplifier, each tube together with its circuit is called a "stage" of amplification. There are several methods of connecting the output of one stage to the input of the next stage. You remember that the output of an amplifier tube is taken from the plate and the input is placed on the grid. Since the DC operating voltages of a plate and of a grid are so very different, a simple wire leading from one plate to the next grid cannot be used. The connection (or "coupling" as it is more commonly called) between two stages must, in some way, prevent the DC plate voltage from getting to the next grid. At the same time, the coupling must permit the plate voltage variations—AC—to become the input of the next stage.

There are two very common and very simple ways of doing this. One way is by using a transformer, the other by using a capacitor and a resistor.

Transformer coupling is accomplished by connecting the primary winding between the plate of the first tube and B+, and the secondary winding between the grid of the second tube and ground. By so doing, the B+ voltage is isolated in the plate circuit while only the AC is transferred to the grid.

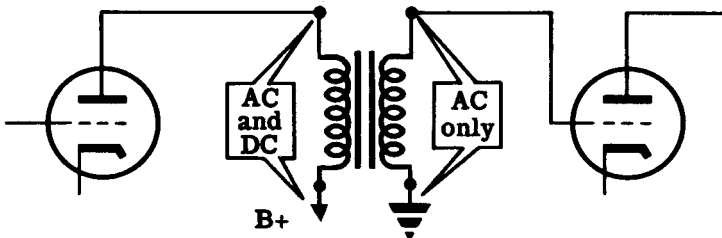

TRANSFORMER COUPLING

The use of the capacitor in coupling circuits is very widespread, the most common circuit being the RC (or resistance-capacitor) circuit. In your study of vacuum tubes, you learned that current variations in the load resistor cause the voltage at the plate to vary above and below a steady value. The coupling capacitor will charge to that steady voltage and, as the plate voltage rises above and falls below that value, the capacitor will charge and discharge slightly, causing an AC current to flow in the grid resistor. The voltage across the grid resistor therefore is AC and is the input to the next stage.

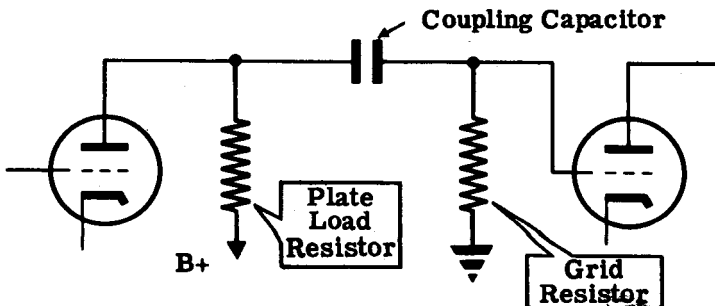

RC COUPLING

## THE TWO-STAGE RC COUPLED AMPLIFIER

### Characteristics of the Two-Stage Amplifier

The two-stage amplifier can be compared to two step-up transformers with the secondary of one connected to the primary of the other. For example, if two transformers which have a step-up ratio of 1 to 3 are connected in this manner, an AC voltage applied to the primary of the first transformer would be amplified 9 times by the combination. This example is illustrated below.

### OBTAINING VOLTAGE AMPLIFICATION WITH A TRANSFORMER AND VACUUM AMPLIFIER

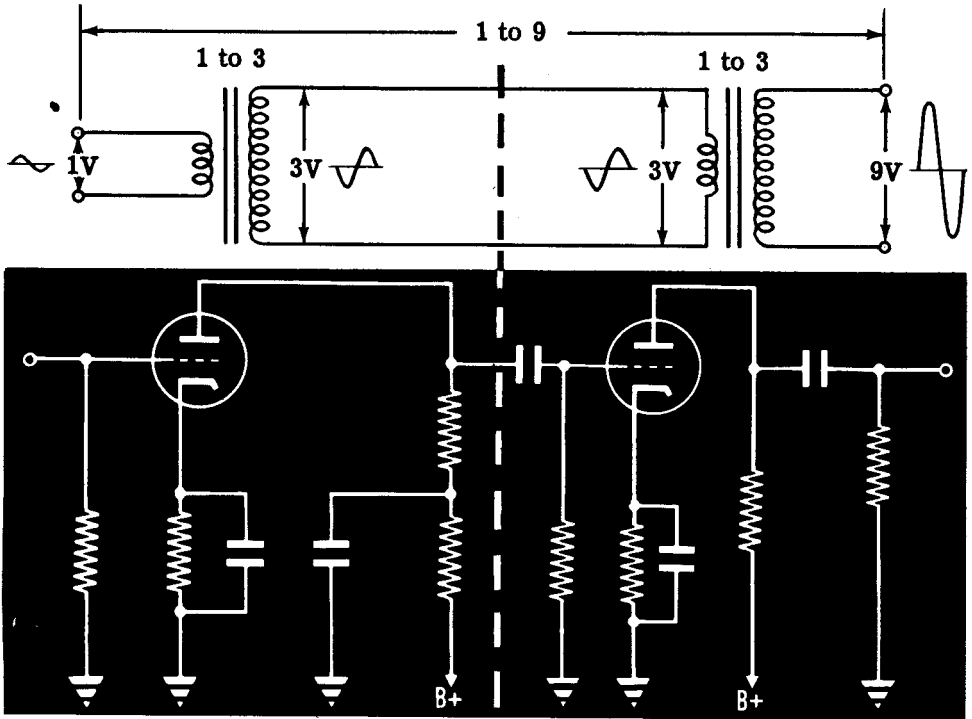

You may conclude from this that it would be a good idea to forget all about using vacuum tubes as amplifiers and use transformers instead. This is not possible because transformers with very high step up ratios would have to be used if they were to deliver a high amplification. Transformers of this type are impractical and even if they were used would not amplify all the audio frequencies the same amount. The higher audio frequencies (around 10,000 cycles) and the lower audio frequencies (around 100 cycles) would not be amplified as much as the middle frequencies. This would result in a signal output that is not a true representation of the original signal applied to the transformers.

Amplifiers using vacuum tubes can deliver much higher amounts of amplification, are lighter in weight, less costly and take up less space. On the next sheet you will see how a multistage vacuum tube amplifier compares to the transformer combination explained here.

## THE TWO-STAGE RC COUPLED AMPLIFIER

### Characteristics of the Two-Stage Amplifier (continued)

When the output of one amplifier is fed to the input of another, the two amplifiers are said to be connected in cascade. An amplifier arrangement of this type is shown below.

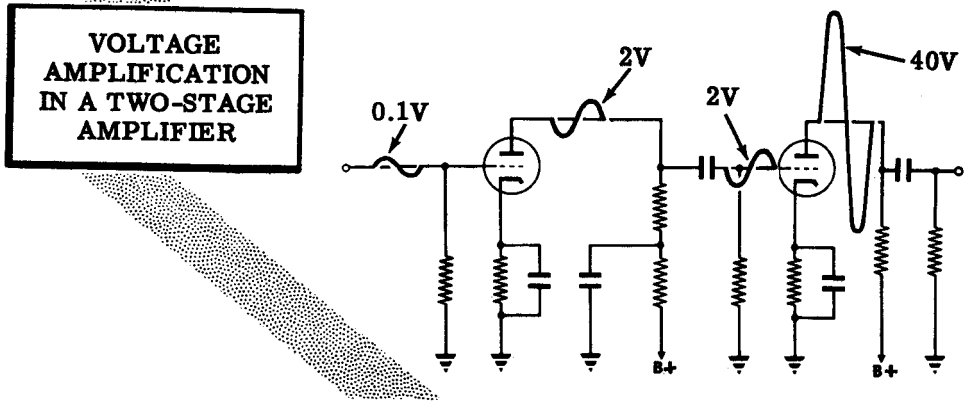

Suppose each amplifier stage can deliver an amplification of 20. If a 0.1 volt AC signal is applied to the grid of the first stage, the output of this stage will be  $20 \times 0.1 = 2\text{V}$ . Since the output of the first stage is connected to the input of the next stage there will be 2 volts AC on the grid of the second stage. The second stage amplifies the signal 20 times and produces an output voltage of  $20 \times 2 = 40\text{V}$ .

The overall amplification of the two stages is the product of the individual amplifications, that is, the gain of the first stage  $\times$  the gain of the second stage. In this case the overall amplification is  $20 \times 20 = 400$ . You can check this by multiplying the input voltage of 0.1 volts by the overall amplification. The result will be the output voltage ( $400 \times 0.1 = 40\text{V}$ ).

If another stage is added to the output of the two-stage amplifier, 40 volts would be applied to its grid. In most cases, this signal would be too large for the tube to handle. The result is that the grid would be driven into the positive region and the cut-off region, and distortion produced. A potentiometer in the grid circuit of one of the amplifier tubes could be used to reduce the output signal so that the following stages would not be overdriven. This potentiometer is commonly referred to as the volume control.

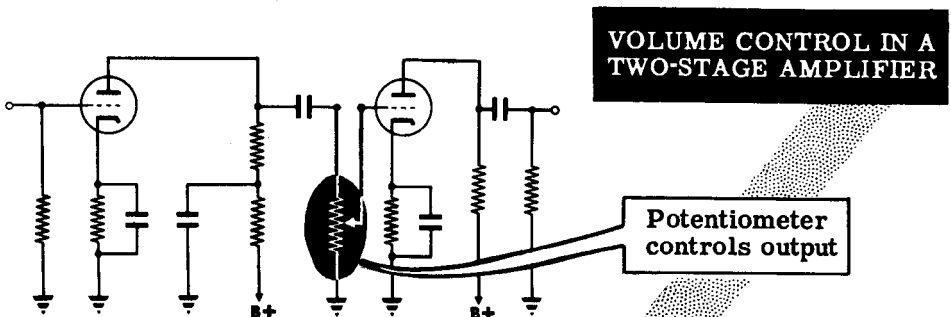

# THE TWO-STAGE RC COUPLED AMPLIFIER

## Frequency Response

Frequency response is a term applied to describe the effect in which some frequencies are amplified more than others. In actual practice, all amplifiers have a range over which they are designed to operate; above and below this range the signal output drops off rapidly. If an audio amplifier cannot amplify all the frequencies of the human voice by an equal amount, there is a loss of voice quality.

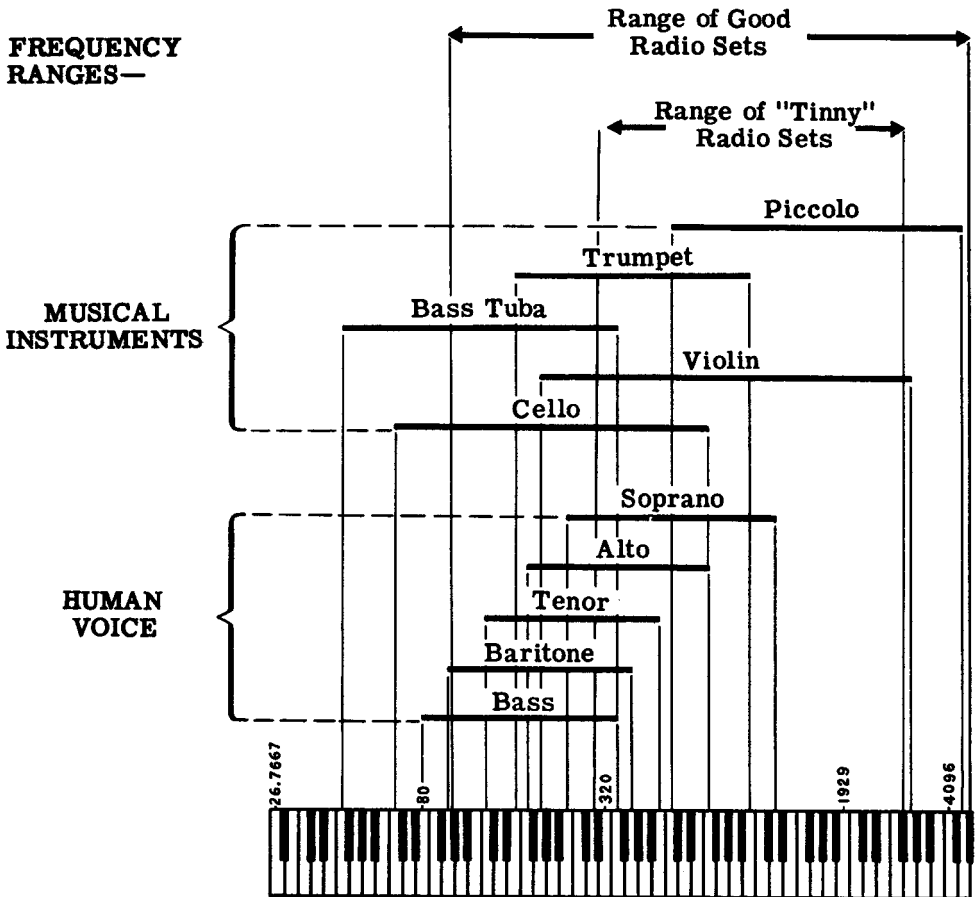

It is possible for this frequency distortion to be so great that the voice message cannot be understood. For this reason you should learn to measure the frequency response of your amplifier and see how good it actually is. A modern commercial amplifier designed for music amplification will have an equal gain from 30 - 15,000 cycles. A range as wide as this is hardly necessary for good amplification of voice signals.

## THE TWO-STAGE RC COUPLED AMPLIFIER

### Frequency Response (continued)

Even though the RC-coupled amplifier is well suited for the job of amplifying a wide range of frequencies, there are still causes for a drop in gain at high and low frequencies. Let's take a quick look at these causes:

At low frequencies the coupling capacitor and the grid resistor make up a voltage divider across the signal voltage input. As a result, only part of the signal gets to the grid of the amplifier tube. Just how much of the signal gets to the grid depends upon the reactance of the coupling capacitor as compared to the resistance of the grid resistor.

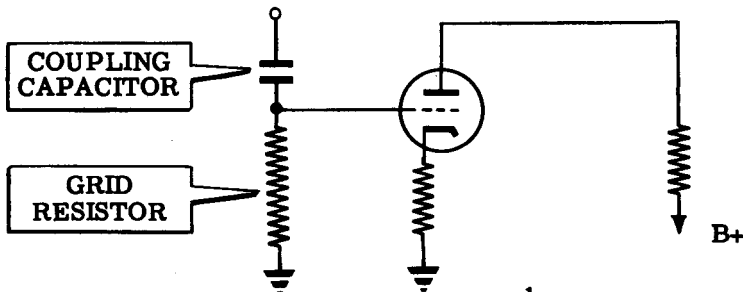

Due to the fact that capacitive reactance ( $X_C = \frac{1}{2\pi fC}$ ) grows larger as frequency decreases, the amount of signal voltage lost across the capacitor increases at low frequencies. You can see that the signal voltage across the grid resistor becomes less and less as the frequency decreases. To reduce this loss of signal, the reactance of the coupling capacitor should be small with respect to the grid resistor at the lowest frequency to be amplified. This means that either the grid resistor or the coupling capacitor should be as large as possible. (If  $C$  increases,  $X_C$  decreases.)

However, if the coupling capacitor is made too large, there will be increased leakage through it from B+. This leakage will place a positive voltage on the grid and thereby disturb the amplifier operation. Luckily, we never need coupling capacitors that are so large that leakage becomes a problem. In fact, because of size and weight considerations, it is common to use a smaller coupling capacitor than is needed. Thus, low frequency response is sacrificed slightly so as not to bring about more serious problems. At high frequencies the coupling capacitor is no longer a cause of trouble, since its reactance is low compared to the grid leak resistor.

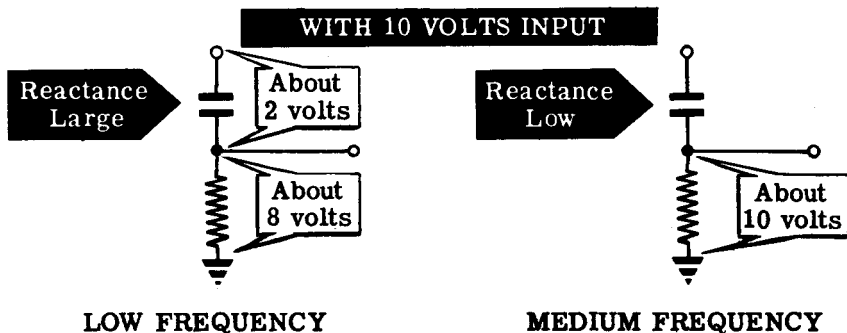

## THE TWO-STAGE RC COUPLED AMPLIFIER

### Frequency Response (continued)

At high frequencies, too, there is an effect that causes a loss of amplification. This loss is due to total stray capacitance that exists between the grid and ground. This total capacitance consists of the plate-to-cathode interelectrode capacitance of the tube from which the signal is taken, the grid-to-cathode capacitance of the tube to which the signal is brought, and the stray capacitances between the signal-carrying wires and the chassis.

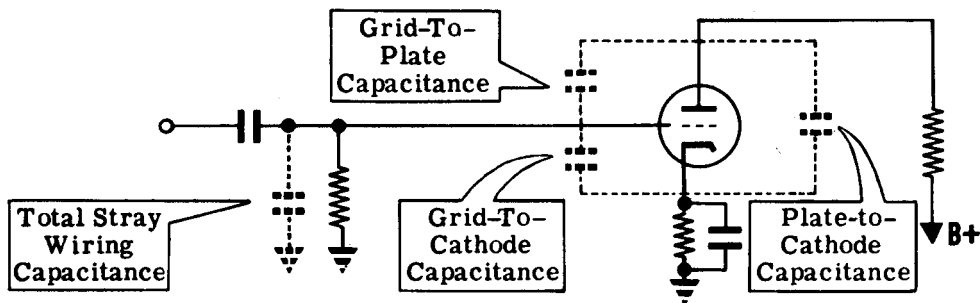

The effect of this total capacitance is to shunt the grid leak resistor. At low and medium frequencies the reactance of this small capacitance is high and therefore it does not disturb the operation of the circuit. At high frequencies, the reactance drops and effectively decreases the impedance between grid and ground. The signal appearing between grid and ground decreases as the impedance between grid and ground decreases.

Thus, the gain at high frequencies is less than at medium frequencies because of the shunting effects of the total stray and interelectrode capacitances. It is important to note that a low gain in itself is not bad; if the same gain existed for all frequencies, there would be no problem. Difficulties with frequency response are encountered only when there are unequal gains at different frequencies.

### WITH 10 VOLTS INPUT

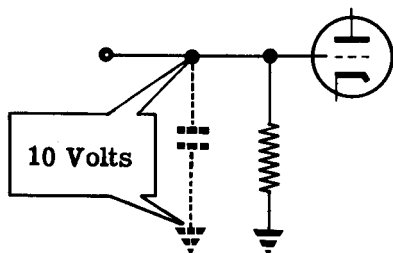

AT MEDIUM FREQUENCIES

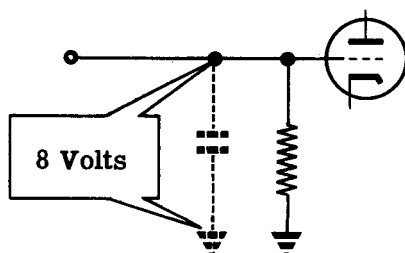

AT HIGH FREQUENCIES

The solution to the problem of loss of gain at high frequencies is to use special amplifier tubes with very low values of input and output capacitances, to use special wiring techniques to reduce the stray capacitance between the wire and ground, and to use lower values of resistors in the RC coupling. These methods increase the frequency at which the shunting effect becomes noticeable.

## THE TWO-STAGE RC COUPLED AMPLIFIER

### The Frequency Response Curve

The usual way that the frequency response of an amplifier is shown is with a frequency response curve. In this curve, a plot is made of the gain at each frequency; the highest gain is 100 percent (or sometimes 1.00) and any gain below that is figured as a certain percent of maximum—such as 75 percent, 25 percent, and so forth.

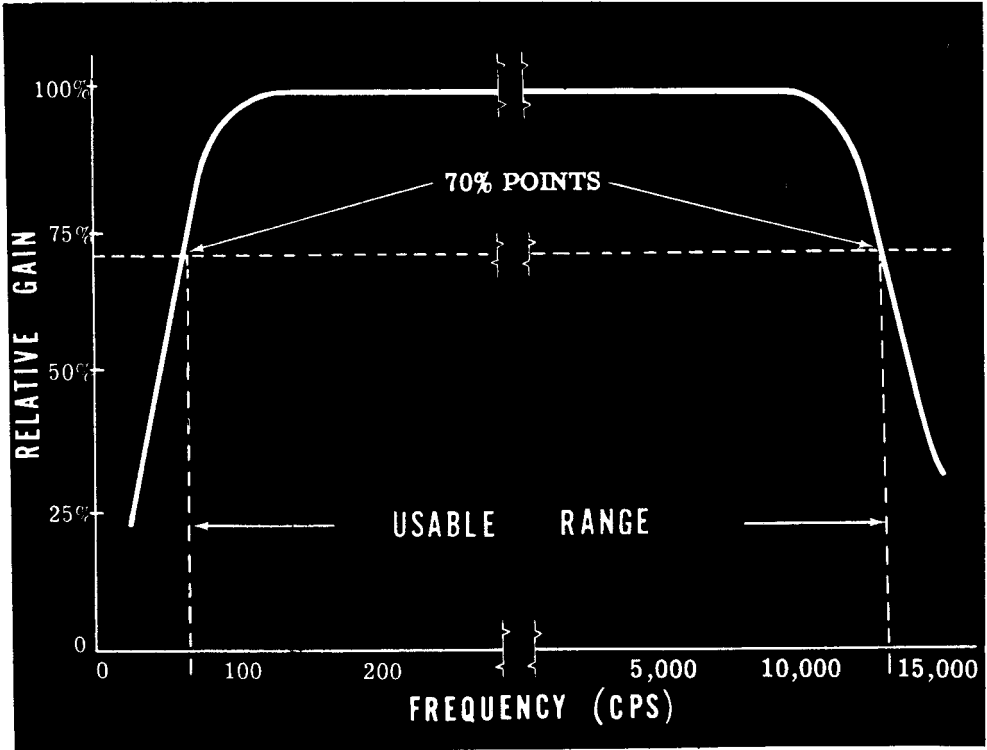

The general shape of the curve shows a flat region (plateau) between the ends of the curve. This means that the gain does not vary by very much as the frequency changes from the low end to the high end of this portion. This represents the usable frequency range of the amplifier.

On either side of this flat portion, there is a rapid falling-off of the curve. This means that the gains at these frequencies (both low and high) are not as high as the gain at the middle frequencies. In a speaker, the ear can detect these lowered gains if they are about 70 percent of maximum or below. Therefore, it is the 70-percent points on each end of the curve that determine the usable range.

As you remember from the previous discussions on frequency response, the reason for the decreased gain at the low end of the band was the fact that the coupling capacitor and the grid leak resistor form a voltage divider. The reactance of the coupling capacitor increases at the low frequencies, and the voltage across the resistor decreases. At the high end, the loss of gain is due to the shunting effect of the stray capacitances between grid and ground. At the middle frequencies, neither effect is noticeable and the gain does not vary by any appreciable amount.

# THE TWO-STAGE RC COUPLED AMPLIFIER

## Review of the Two-Stage Amplifier

**RC COUPLING** — When two or more stages are used in an amplifier, the AC plate voltage of each stage is fed to the grid of the next stage through the coupling capacitor and resistors.

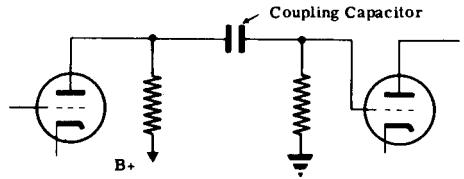

**VOLTAGE GAIN** — The total amplification of a two-stage (or multistage) amplifier is the product of the amplifications of each stage. The ratio of the output voltage of final stage to the input voltage of first stage is called the gain of the amplifier.

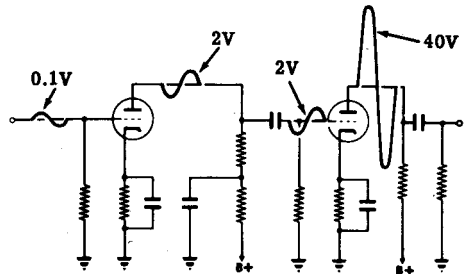

**AMPLIFICATION LOSSES** — At low frequencies the high reactance of the coupling capacitor reduces voltage gain; at high frequencies stray capacitance causes loss of voltage gain.

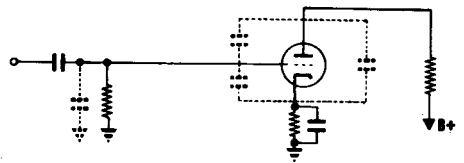

**FREQUENCY RESPONSE** — A measure of the ability of an amplifier to amplify AC signals of various frequencies by the same amount.

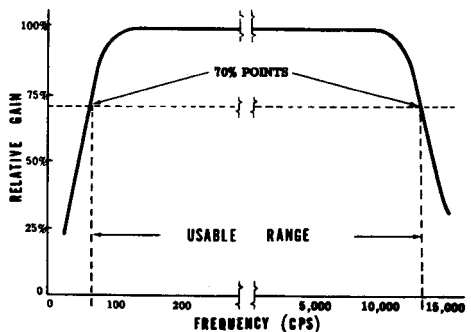



# THE TRANSFORMER-COUPLED AMPLIFIER

## Transformer Coupling

A transformer-coupled amplifier is an amplifier that makes use of transformer coupling instead of RC coupling between the stages. This method is most often used to couple an amplifier to its load, but it also may be used for interstage coupling. One advantage of using a transformer is that the secondary winding may have more turns than the primary winding, resulting in a voltage step-up. In addition, there is no sizable voltage drop in voltage at the plate of the amplifier tube as in the case of using a plate load resistor, and no coupling condenser is required. In transformer coupling the maximum gain is  $\mu \times N$  where "N" is the ratio between the number of turns in the primary and secondary windings and  $\mu$  is the amplification factor of the tube. In resistance coupling the maximum possible gain is only the  $\mu$  of the tube.

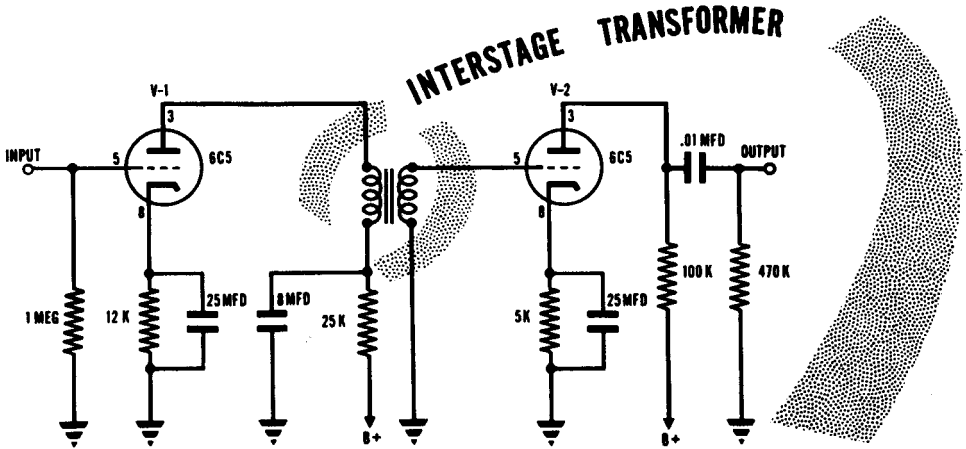

The reasons why transformer coupling is not widely used are, first, that a transformer usually has a poorer frequency response than an RC network. Modern high gain tubes cancel any advantages that the transformer has in voltage amplification. In spite of improvements in the design of interstage transformers, the trend is toward using high gain vacuum tubes with RC rather than transformer coupling between the stages of the amplifier.

There are many applications in which transformer stages have a particular advantage. Some of these applications include: High output for limited power supply voltage, impedance matching between low and high impedance lines and push-pull applications. In push-pull amplifiers a transformer is more readily adaptable than resistance coupling, and unlike an RC coupling, it places a low DC resistance in the grid circuit of the following amplifier under conditions where a low DC resistance is essential.

INTERSTAGE TRANSFORMERS

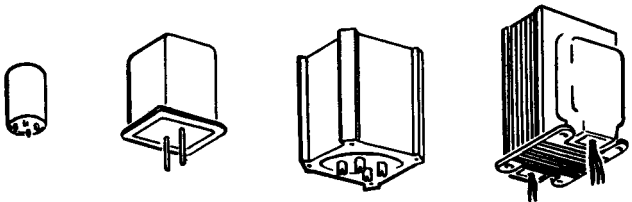

## THE TRANSFORMER-COUPLED AMPLIFIER

### Transformer Coupling (continued)

The main disadvantage of transformer coupling is that the impedance of the primary and secondary windings is not constant, but changes if the frequency of the signal is changed. If the frequency increases, the impedance increases and when the frequency decreases, the impedance decreases.

Look at the transformer in the schematic on the previous sheet. Suppose the primary winding has an inductance of 10 henries. At the low frequency of 100 cycles it will have an inductive reactance of—

$$X_L = 2\pi fL = 6.28 \times 100 \times 10 = 6,280 \text{ ohms}$$

At the mid-frequency of 1000 cycles, the inductive reactance will be—

$$X_L = 2\pi fL = 6.28 \times 1000 \times 10 = 62,800 \text{ ohms}$$

and at 10,000 cycles, it would be—

$$X_L = 2\pi fL = 6.28 \times 10,000 \times 10 = 628,000 \text{ ohms}$$

Since the inductive reactance of the primary is used as the plate load impedance of the triode amplifier, the inequality of reactance to AC signals of different frequencies will produce non-uniform amplification over the audio frequency range. A graph of the amplification of a transformer-coupled amplifier is shown below. Compare the graph of the transformer-coupled amplifier with that of the RC-coupled amplifier. Notice how much more uniform the amplification of the RC-coupled amplifier is.

THE AMPLIFICATION OF AN RC-COUPLED AMPLIFIER AND A TRANSFORMER-COUPLED AMPLIFIER AT AUDIO FREQUENCIES

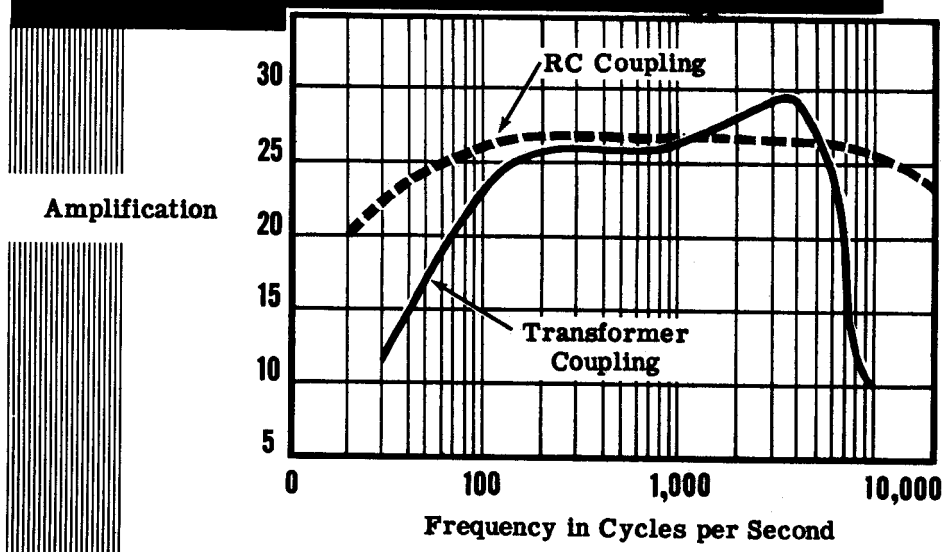

## THE TRANSFORMER-COUPLED AMPLIFIER

### Characteristics of the Transformer-Coupled Amplifier

The transformer-coupled amplifier shown below is typical of most amplifiers of this type. The amplifier has two stages coupled by an inter-stage audio transformer that has a 3 to 1 step-up ratio. The input stage uses a 6C5 triode V-1. The amplified output voltage of this tube is stepped up 3 times by the transformer and then fed to the grid of another 6C5 triode V-2. The second triode amplifies the signal still further and its amplified output appears across the 100K plate load resistor. The 0.01 mfd coupling capacitor blocks the DC but presents a low reactance to the AC component at the plate of V-2. Therefore, only the AC component of the plate voltage at V-2 appears across the 470K resistor. Normally, the 470K resistor would be the grid resistor of the next stage so that the signal across the resistor could be amplified further.

## TRANSFORMER-COUPLED AMPLIFIER

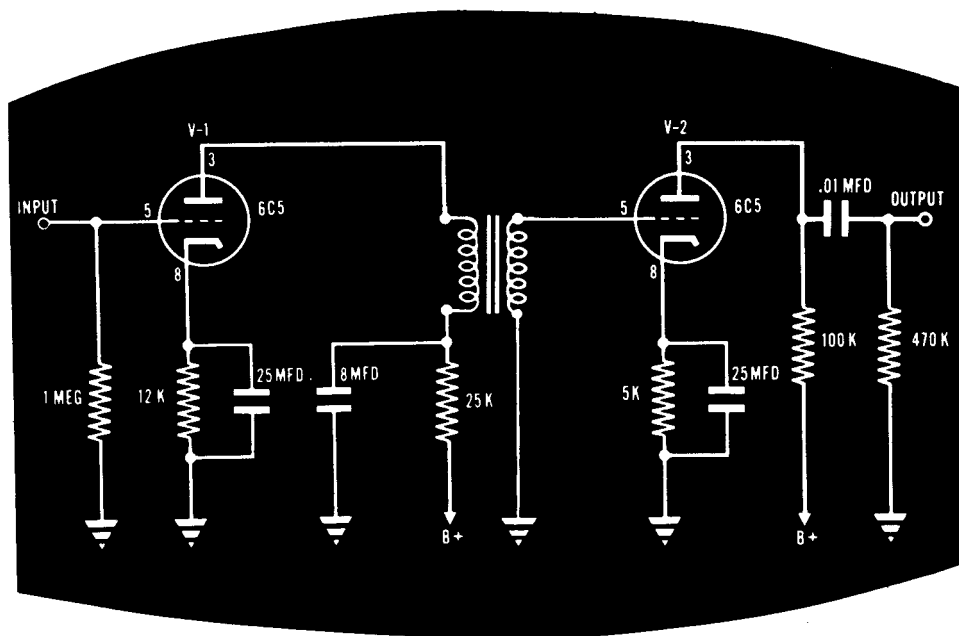

On the next sheet, a signal will be traced through the transformer-coupled amplifier and you will see how amplification occurs in this circuit.

## THE TRANSFORMER-COUPLED AMPLIFIER

### Characteristics of the Transformer-Coupled Amplifier (continued)

The amplification that can be expected from a transformer-coupled amplifier stage is approximately equal to the amplification factor ( $\mu$ ) of the tube times the turns ratio of the transformer ( $N$ ). Amplification =  $\mu \times N$ . In this case, a 6C5 tube is used which has a  $\mu$  of 20. The transformer has a step-up turns ratio of 3 to 1. Therefore, we can expect an amplification or gain of  $-\mu \times N = 20 \times 3 = 60$ .

Suppose a 0.01 volt AC signal is applied to the grid of V-1. From the illustration you can see that the output voltage of the 6C5 appears across the primary winding of the transformer and is amplified  $\mu$  times ( $20 \times .01 = 0.2V$ ). The transformer steps up the primary voltage 3 more times so that the secondary voltage is  $3 \times 0.2 = 0.6V$ .

It was stated that the gain of this stage is equal to  $\mu N$  or 60. Let us see if this checks. The grid signal is 0.01V. If we multiply this grid voltage by the gain we should get the voltage at the secondary of the transformer, or 0.6V. Multiply  $60 \times 0.01 = 0.6V$  and you can see that this relationship holds.

#### VOLTAGE AMPLIFICATION IN A TRANSFORMER-COUPLED AMPLIFIER

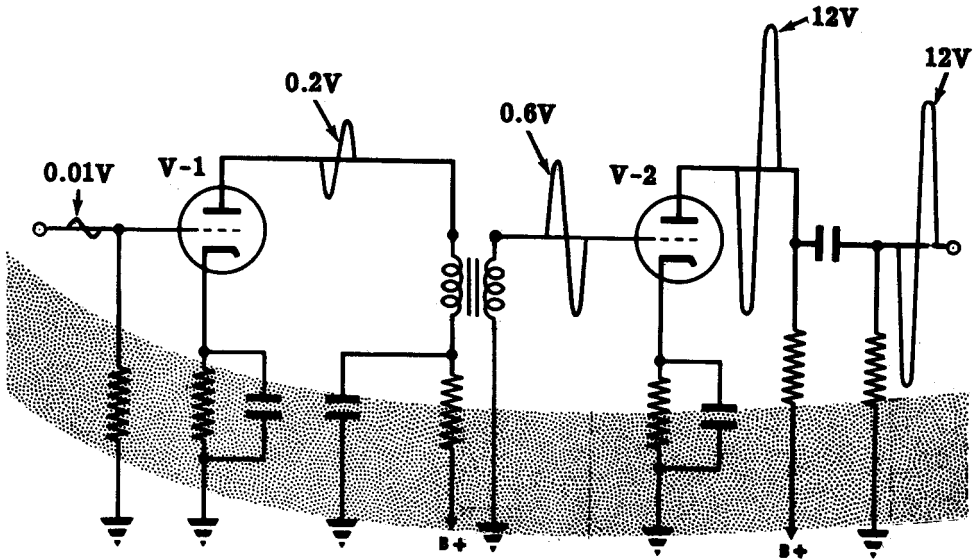

The voltage across the secondary of the transformer (0.6V) is now applied to the grid of V-2. If we assume that the gain of V-2 is equal to  $\mu$ , then V-2 will amplify this signal 20 times. Therefore, the output voltage at the plate of V-2 will be  $-20 \times 0.6 = 12V$ .

The total gain is determined by multiplying the individual stage gains together. The gain of V-1 and the transformer is 60 and the gain of V-2 is 20. The overall gain is  $-60 \times 20 = 1200$ .

Checking this result, the input to V-1 times the overall gain should give us the output voltage of V-2— $1200 \times 0.01 = 12V$  which is correct.

# THE AUDIO POWER AMPLIFIER

## Characteristics of Audio Power Amplifiers

Up to this time you have been learning about audio amplifiers that are primarily designed to amplify the signal voltage up to many times the original input voltage. Now you will learn about power amplifiers. In a voltage amplifier the varying signal current in the plate circuit is used only in the production of a voltage to be applied to the grid of a following stage. The plate current is usually relatively small.

On the other hand, a power amplifier must supply a heavy signal current into a load impedance which usually lies in the range of 2000 to 20,000 ohms. Power amplifiers are used to drive power-consuming circuits or devices, such as loudspeakers, certain portions of transmitters and large amplifier stages whose grids require power from the preceding stage.

One use of audio power amplifiers is, of course, to produce a powerful audio signal. The radioman will find it used as the output stage of his receivers, and also in equipment which injects voice signals into transmitters. The sound man will find this circuit in almost every piece of his sound equipment. The sonarman will find audio power amplifiers used to produce the signal to drive not only a loudspeaker but also the underwater sound element called a transducer. Audio power amplifiers are also used in equipments which rotate radar antennas, sonar transducers and ship's guns.

### POWER AMPLIFIERS

Are Used in Many Types of  
Equipment

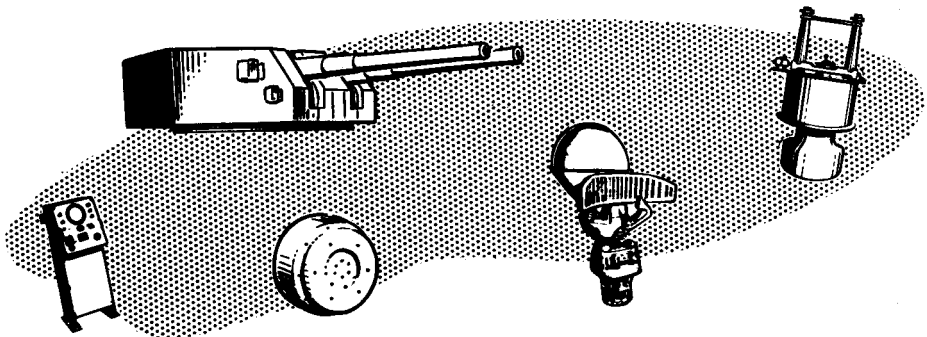

# THE AUDIO POWER AMPLIFIER

## Characteristics of Audio Power Amplifiers (continued)

You have learned in the preceding topics that the main purpose of voltage amplifier circuits is to produce a large increase in signal voltage. The amplified output of the voltage amplifier will now be applied to the grid of a power amplifier stage.

In the voltage amplifier circuits the output of one voltage amplifier is connected to the grid of the next stage. No current flows in this grid circuit, therefore no power will be consumed. If current did flow in the grid circuit, the power loss in this circuit would have to be supplied by the preceding stage. In the case of an amplifier that feeds a loudspeaker, the speaker requires large amounts of AC signal current for proper operation. When current flows in a circuit, power is always consumed. The power amplifier stage must supply the power that is consumed in the loudspeaker circuit.

The tubes used in voltage amplifier circuits are generally operated as Class A while the tubes used in power amplifier circuits may be operated either as Class A, Class B or Class AB.

Triodes, pentodes and beam power tubes can be used as power amplifiers. These tubes may be operated singly, in parallel, or in push-pull. The type of operation depends upon the amount of power required of the amplifier.

Voltage amplifiers are usually operated with a high value of plate load resistance or impedance to obtain the maximum voltage output. Power amplifier tubes are operated with lower values of load impedance to obtain a large current variation and a large power output. In a power amplifier, the amount of voltage output is not important for it is the power output which is the main factor.

If large amounts of power are to be supplied by the power amplifier, it must be capable of carrying high current—much more current than a voltage amplifier.

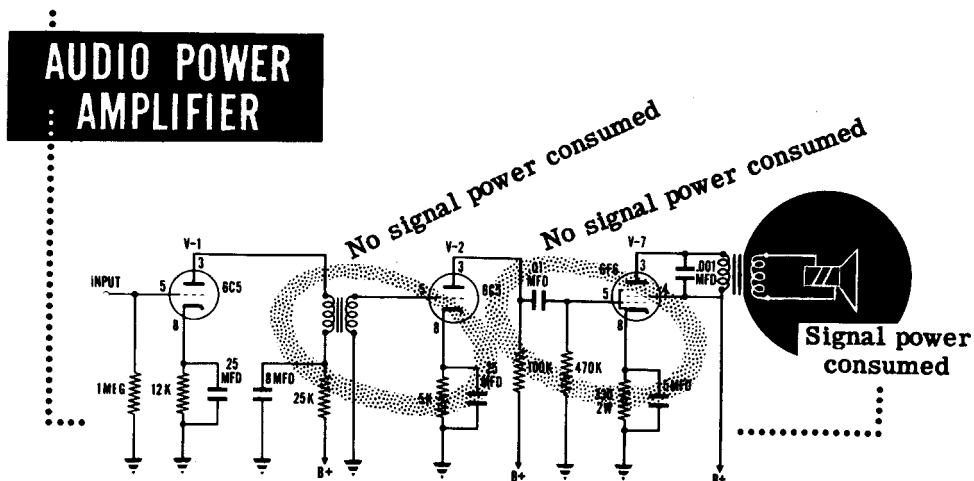

## THE AUDIO POWER AMPLIFIER

### Characteristics of Audio Power Amplifiers (continued)

The current that flows through the plate circuit of the power amplifier tube is made up of two parts:

1. A steady or DC component
2. A varying or AC component

The useful part of the plate current is the varying component as only variations in plate current produce sounds in the loudspeaker. The AC component of plate current flows through the primary of the output transformer along with the DC component. The DC component just produces a steady magnetic field about the primary winding and does not induce any voltage into the secondary. The AC component makes use of transformer action and induces a voltage into the secondary which is applied to the voice coil of the loudspeaker. This voltage is converted into sound by the loudspeaker.

You can see that the steady plate current does not contribute directly towards the sound output of the power amplifier circuit. This portion of the plate current does produce a power loss in the plate circuit which produces heating of the power amplifier tube and the output transformer.

## AC AND DC CURRENTS

## IN A POWER AMPLIFIER

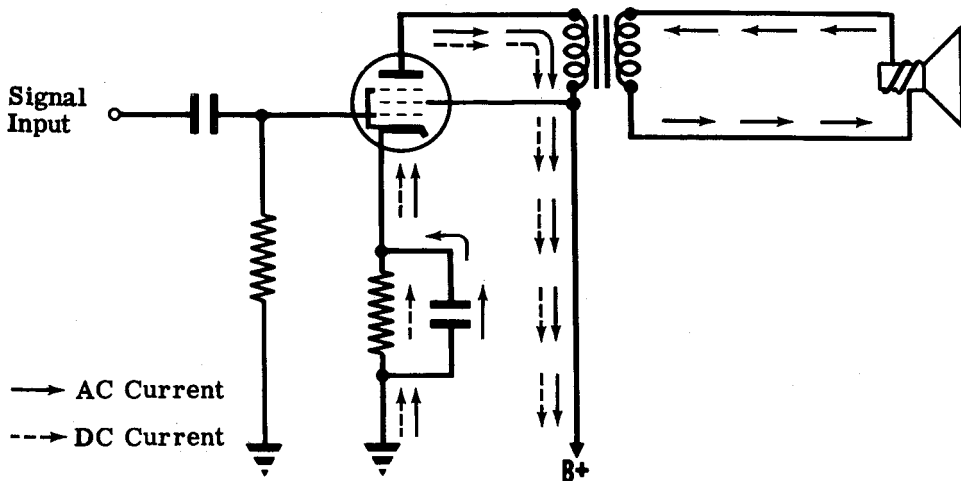

## THE OUTPUT TRANSFORMER

### The Job of the Output Transformer

The output transformer's job is to couple the amplified audio power from the plate of the power amplifier tube to the voice coil of the loudspeaker. In these next few sheets you will learn about the characteristics of output transformers so that you will be able to understand the importance of impedance matching. Impedance matching is necessary because the power amplifier must have a relatively high impedance plate load while the voice coil impedance is low. The output transformer matches the low impedance voice coil to the high impedance plate circuit.

Power amplifier tubes must operate into a specified value of plate load impedance for maximum power output and minimum distortion. The correct value of load impedance for a particular tube can be obtained from the tube manufacturer's references.

In a power amplifier circuit, the primary winding of the output transformer is used as the plate load impedance and it is this impedance with which we are concerned. The primary impedance is determined by the size of the load on the secondary and the turns ratio between primary and secondary. The turns ratio and the size of the secondary load impedance must be so chosen that the resultant primary impedance is the correct value for the required load impedance of the power amplifier tube.

### THE *Output Transformer* IN THE AMPLIFIER CIRCUIT

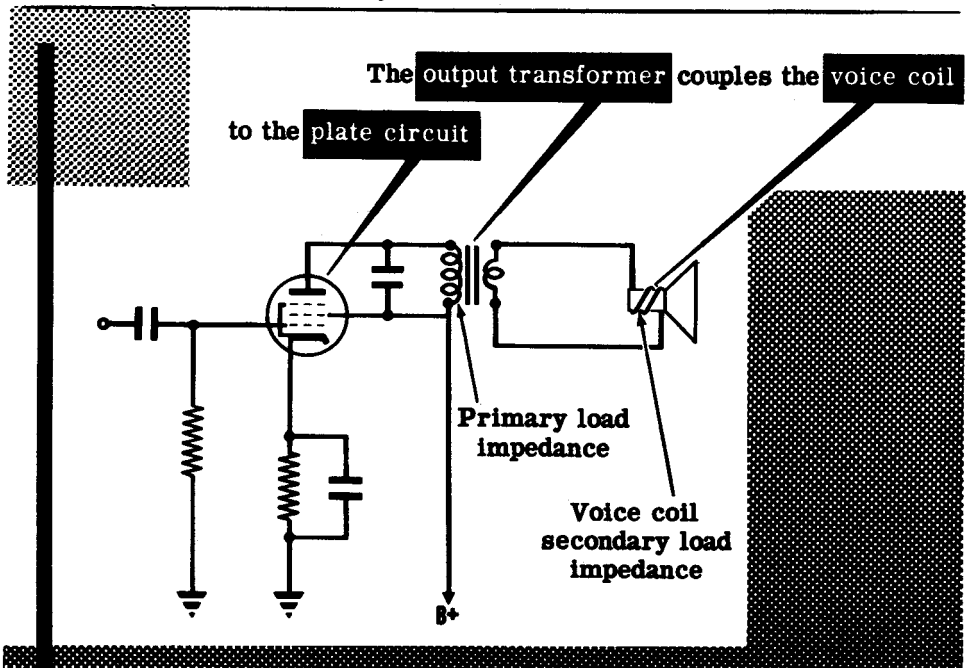



## THE OUTPUT TRANSFORMER

### The Job of the Output Transformer (continued)

In a transformer there are two currents—the primary and secondary currents. The current flow in the primary depends on the amount of current flow in the secondary. If the secondary current increases, then the primary current will also increase. This can be explained by referring to Lenz's law, which states that the magnetic field produced by an induced current is always in opposition to the magnetic field that produced the induced current. In other words, the magnetic field produced by current flow in the secondary of a transformer is in opposition to, and cancels some of, the magnetic field produced by the primary winding. You now can see that if the secondary load impedance is decreased, the secondary current and magnetic field will increase and cancel a greater portion of the primary field. If some of the primary field is cancelled, then the inductive reactance and therefore the impedance of the primary will decrease. By choosing the proper value of secondary impedance, we can obtain the desired primary load impedance for the power amplifier tube.

If the secondary load impedance cannot be changed—for example, the voice coil in a loudspeaker—the turns ratio  $\frac{\text{Primary turns}}{\text{Secondary turns}}$  can be varied to obtain the proper primary impedance. This is done by using an output transformer with a tapped secondary.

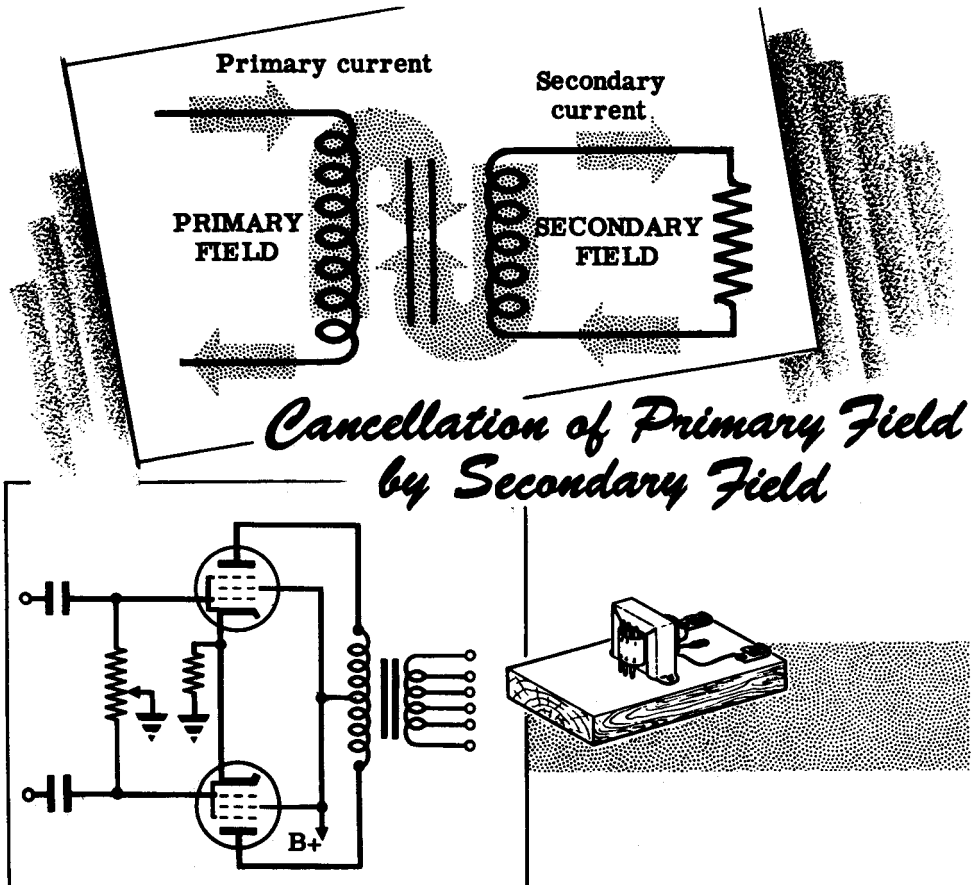

# THE OUTPUT TRANSFORMER

## Impedance Matching

Let us look back at some of the things you have learned up to this point. You know that a power amplifier tube must operate into a specified value of load impedance to obtain maximum power output and minimum distortion. You also know that this load impedance is actually the output transformer primary impedance, which is determined by the load on the secondary.

The secondary load is usually a loudspeaker and it is to the speaker that we wish to supply the amplified audio power. You may be thinking that it would be simpler to connect the speaker directly to the plate of the power amplifier tube but this is not possible. You recall that the plate load for the power amplifier cannot be anything but the specified value. This load is usually in the order of several thousand ohms while loudspeaker voice coil impedances are in the order of 1 to 15 ohms. If the voice coil impedance was used as the plate load, the amount of power obtainable from the amplifier would be very small to say nothing of the distortion that would result.

Therefore, we must use an impedance matching device, the output transformer, which will allow us to operate the tube into the high impedance primary and still, supply audio power to the low impedance loudspeaker voice coil.

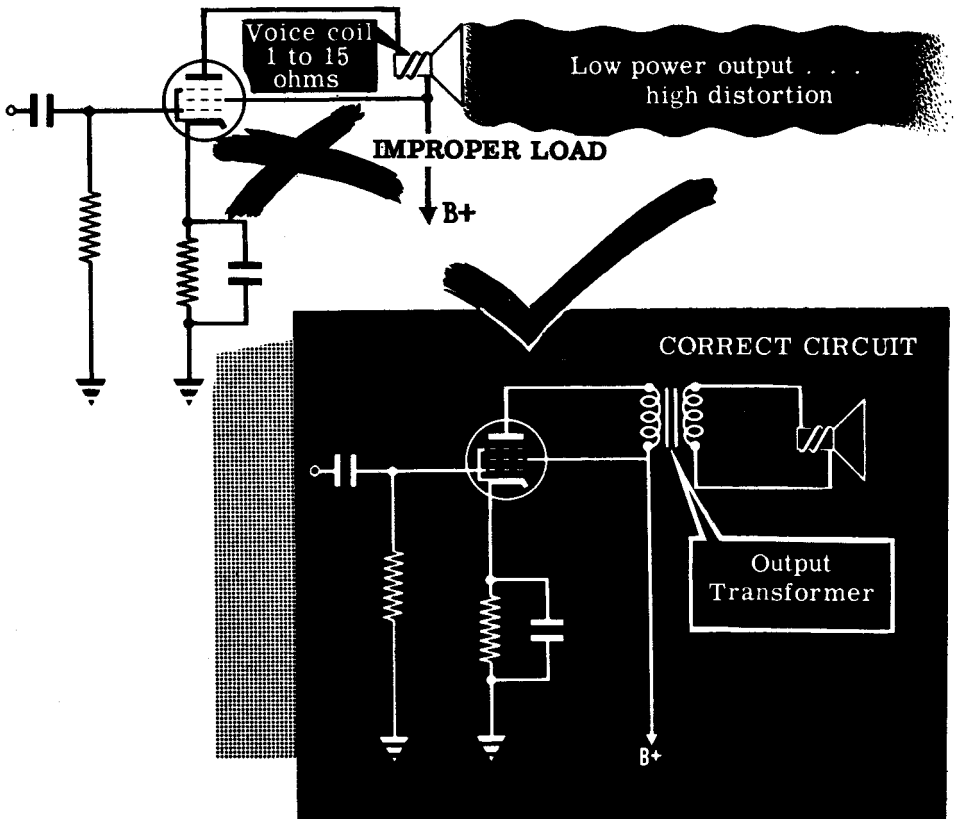

## THE OUTPUT TRANSFORMER

### Impedance Matching (continued)

Loudspeaker impedances and plate load impedances for different tubes vary widely. Since the primary impedance is set by the type of tube being used and the secondary load is set by the voice coil impedance, there must be some means of adjusting the relationship between primary and secondary impedance to obtain proper matching. The means of matching the two impedances is by varying the turns ratio of the transformer.

The output transformer that is shown below has a multi-tapped secondary so that you can select different numbers of secondary turns. Since the primary turns are fixed, if the secondary turns are varied then the turns ratio of the transformer is also varied. The primary impedance ( $Z_p$ ) is related to the secondary load impedance ( $Z_s$ ) by the following formula

$$Z_p = N^2 Z_s$$

where  $N$  is the turns ratio of the transformer  $\frac{N_1}{N_2}$ ,  $N_1$  is the primary turns

and  $N_2$  is the number of secondary turns used. You can see that if the value of  $Z_s$  is fixed by the voice coil impedance, any value of  $Z_p$  can be obtained by varying the turns ratio.

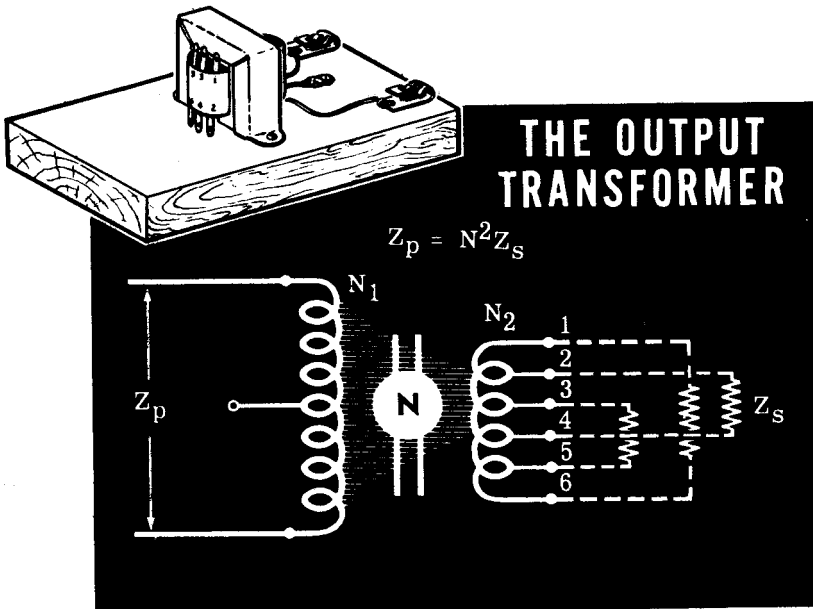

## THE PUSH-PULL AMPLIFIER

### How the Push-Pull Amplifier Works

In this topic, you will see that a very good type of power amplifier can be made by using a push-pull system. A power amplifier can be made using only one tube, but when you want to double the power, it is often more convenient to use two power tubes, rather than use one very large power tube. The obvious way to use two tubes would be to connect the two grids together and the two plates together (parallel connection) and thereby double the power output. However, there is a way that is better—that is to connect the tubes in push-pull. In a push-pull amplifier the input voltages to the grids of the two tubes are 180 degrees out of phase. This phase difference is often achieved by putting the signal into the primary of a transformer with a center-tapped secondary—the two grids are connected to the opposite ends of the secondary and the center tap is grounded or connected to a source of grid bias voltage.

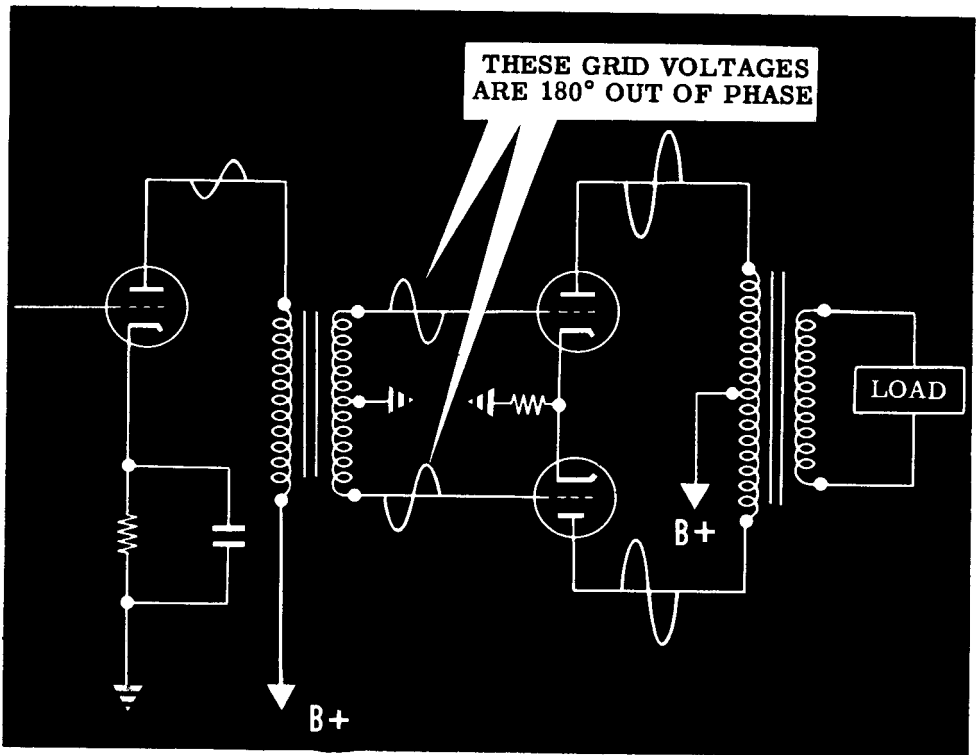

### A TYPICAL PUSH-PULL CIRCUIT

The plates are connected to opposite ends of the primary winding of an output transformer and the center tap is connected to B+. The final output voltage appears across the output transformer secondary which is connected to the load.

# THE PUSH-PULL AMPLIFIER

## How the Push-Pull Amplifier Works (continued)

In a typical push-pull amplifier, the grids receive AC voltages from opposite terminals of a transformer secondary winding. The transformer secondary is center-tapped and the center tap is connected to ground. The AC grid voltages are 180 degrees out of phase. When one grid becomes less negative, the other grid becomes more negative by the same amount. The sum of the tube currents does not vary but remains pure DC since, when one current is increasing, the other is decreasing by the same amount. Because the sum of the two currents is pure DC, no bypass capacitor is needed across the cathode bias resistor.

In the output transformer, it is the difference between the two currents that is the output signal. The greater the signal input, the greater this difference and the greater the output.

Below you see a set of typical wave forms taken from a push-pull amplifier which is working normally.

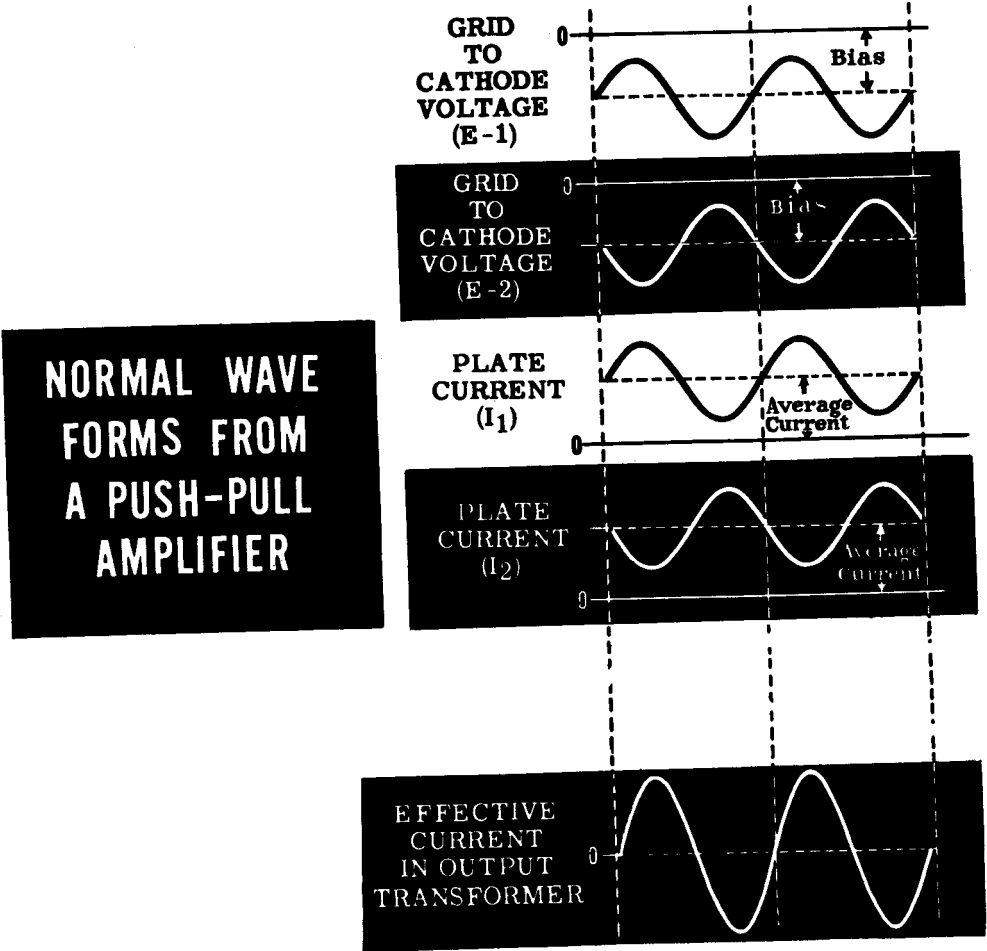

## THE PUSH-PULL AMPLIFIER

How the Push-Pull Amplifier Works (continued)

Up to now, the only advantage of the push-pull circuit that has been mentioned has been the fact that no bypass capacitor is needed since the voltage variations produced across the cathode resistor by the out-of-phase plate current will cancel each other. If this were the only advantage of the push-pull circuit over the use of two tubes connected in parallel, the parallel combination would be more common than it is. Actually, there are some very important advantages which make the use of the push-pull circuit preferable.

Consider what happens if the two tubes in parallel are driven into cut-off by a large signal input. Both tubes go into cut-off together and distortion appears in the output. If the tubes are connected in a push-pull arrangement, one tube will be driven into cut-off on one half-cycle and the other tube on the next half-cycle. In the output, the distortion is minimized as you can see from the wave forms below.

### DISTORTED WAVE FORMS DUE TO CUT-OFF

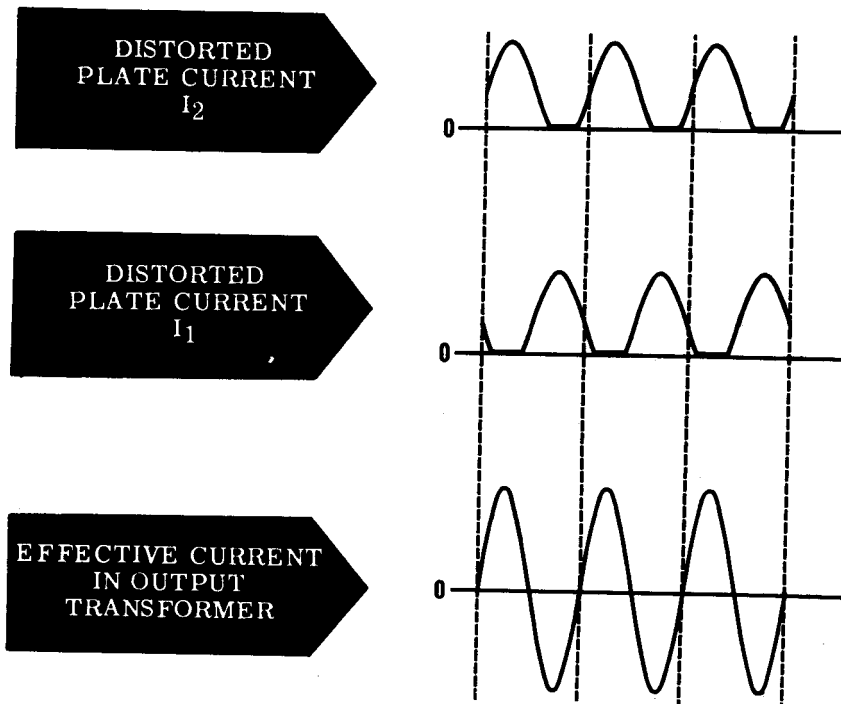

The reason that it is such a big advantage that the push-pull circuit reduces distortion is this—the tubes can be intentionally overdriven to produce a larger output and the output still will be practically undistorted.

# THE PUSH-PULL AMPLIFIER

## Phase Inverters

Transformers are objectionable in some push-pull circuits because of their size, weight and cost. It is sometimes desirable to obtain two signal voltages 180 degrees out of phase with each other without the use of a transformer. A circuit that accomplishes this is called a phase inverter.

You will recall that the two tubes of a push-pull system should be supplied with two signal voltages of equal amplitude but 180 degrees out of phase. In the circuit diagram shown below, the signal for the grid of the upper tube ( $V_2$ ) of the push-pull system comes from the triode ( $V_1$ ), while the other triode ( $V_3$ ) is the phase inverter which drives the other push-pull tube ( $V_4$ ).

The incoming signal is impressed on the control grid of  $V_1$  through capacitor  $C_1$ . The output from  $V_1$  appears across the plate load resistor  $R_3$  and is coupled through capacitor  $C_2$  to the grid of the upper push-pull power amplifier  $V_2$ . The full output of  $V_1$  appears between grid and ground of  $V_2$ —across  $R_4$  and  $R_5$  in series. Resistors  $R_4$  and  $R_5$  form a voltage divider that supplies the signal to the grid of the phase inverter tube  $V_3$ . The values of  $R_4$  and  $R_5$  are so chosen that the amount of signal fed to  $V_3$  is exactly the same as the input signal to  $V_1$ .

The important thing to remember at this time is that there is always a 180 degree phase shift between the signal at the plate of an amplifier tube and the signal at the grid. Therefore, the signal taken from the grid of  $V_2$  at the junction of  $R_4$  and  $R_5$ , will be shifted 180 degrees when it is amplified by  $V_3$ . The output of  $V_3$  is fed through capacitor  $C_4$  to the grid of the lower push-pull power amplifier tube  $V_4$ . Since the signals on the grids of the triodes  $V_1$  and  $V_3$  are equal in amplitude and 180 degrees out of phase, their outputs will also be equal in amplitude and 180 degrees out of phase. You see that these output signals are fed to the grids of the push-pull amplifier so that the requirements for push-pull operation have been met.

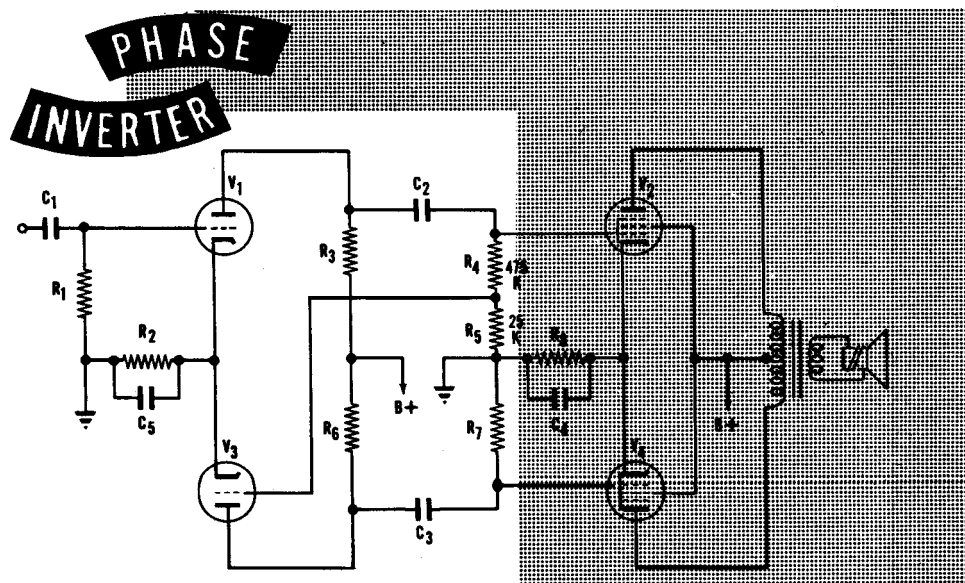

## THE PUSH-PULL AMPLIFIER

### How the Phase Inverter Works

Suppose we apply a signal to the phase inverter and trace it through the complete push-pull amplifier. If a 1 volt signal is applied to the grid of  $V_1$  and we assume the gain of  $V_1$  to be 20, there will be a 20 volt signal at the plate. This signal will appear between grid and ground of  $V_2$ —across  $R_4$  and  $R_5$  in series. Since  $R_4$  is 19 times as large as  $R_5$ , 19 volts will appear across  $R_4$  and there will be 1 volt across  $R_5$ . The 1 volt signal across  $R_5$  is applied to the grid of  $V_3$  at the junction of  $R_4$  and  $R_5$ . Since the gain of  $V_3$  is the same as that of  $V_1$  (20), the output voltage of  $V_3$  will be 20 volts in amplitude and shifted in phase 180 degrees. This output voltage is applied between grid and ground of  $V_4$ .

You can see that we have provided the push-pull amplifier tubes with two signals equal in amplitude (20V) and 180 degrees out of phase so that proper push-pull operation will take place.

## VOLTAGE WAVE FORMS IN A PHASE INVERTER

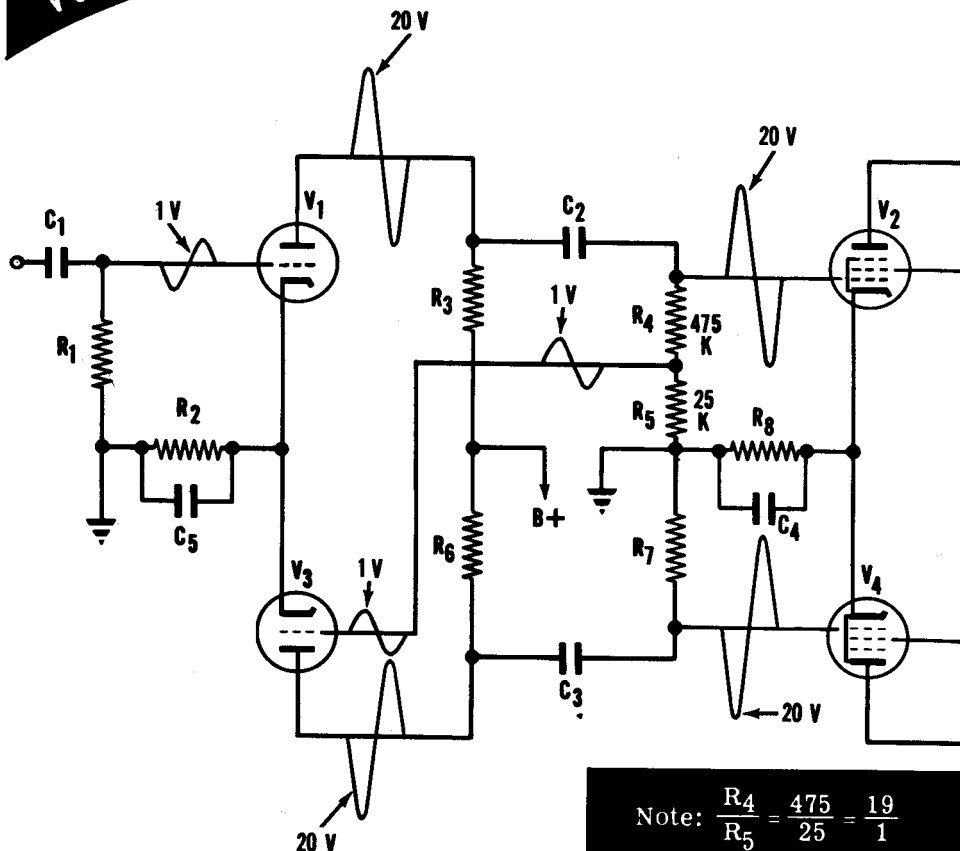



## THE PUSH-PULL AMPLIFIER

### Another Type of Phase Inverter

The phase inverter you will use has half of the load resistance in the cathode circuit (R-1), and half in the plate circuit (R-2). The same current flows in each of these resistors and since they have the same value, the same voltage appears across each of them. These voltages are 180 degrees out of phase. No signal appears across R-3 since it is bypassed with a large condenser.

The input voltage is applied between grid and ground and only part of this signal appears between grid and cathode. The tube current responds to the grid-to-cathode voltage and this current flows through R-1 and R-2, causing signal voltages to appear across these resistors.

The voltage across R-1 (and also the voltage across R-2) is always less than the input voltage. This is so since the grid-to-cathode voltage is equal to the difference between the input voltage and the voltage across R-1. Therefore, the gain of this type of phase inverter (or phase splitter) is less than one.

The two outputs are connected to the control grids of the following push-pull stage. These outputs are 180 degrees out of phase with each other since one is taken from the plate and the other from the cathode. Thus, when the plate current is increasing, the "top" of R-2 is becoming less positive and the "top" of R-1 is becoming more positive. The phase inverter has taken an AC signal input and produced two output signals of equal magnitudes and of opposite phase.

Compare this circuit to the transformer circuit shown below.

### THE SINGLE-TUBE PHASE INVERTER CIRCUIT

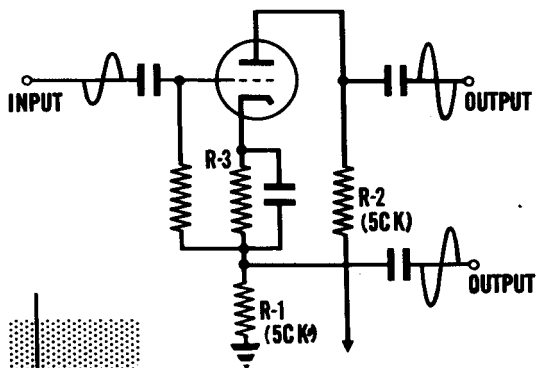

... ACTS LIKE THIS

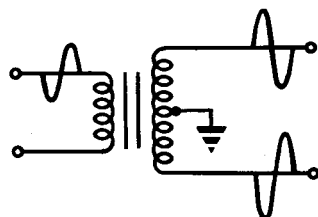

# THE PUSH-PULL AMPLIFIER

Complete Diagram of Push-Pull Power Amplifier

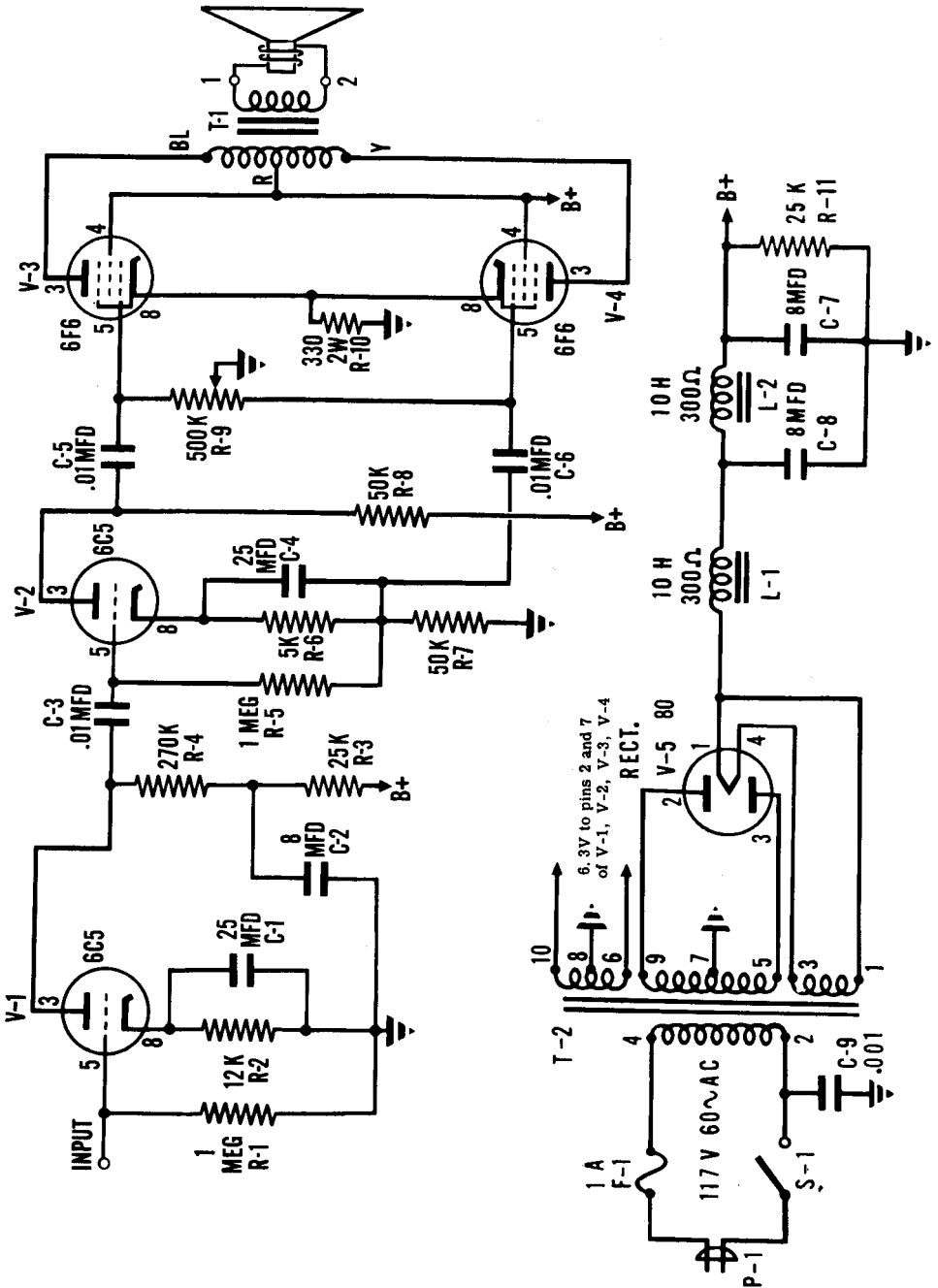

## THE PUSH-PULL AMPLIFIER

### The Advantages of a Push-Pull Amplifier

1. The core of the output transformer is not saturated by DC current flow in the transformer primary winding since the two halves of the primary winding are magnetized in opposite directions. This causes a cancellation of the magnetic lines of flux.
2. More than twice the amount of undistorted power output is produced by using a push-pull system than could be furnished by one tube.
3. Any hum voltages from the plate power supply will be canceled out.
4. No signal is fed from the plates of the power tubes to the rest of the amplifier through the B+ lead because the plate signals cancel out at B+. This also means that no bypass condenser is required across the common cathode resistor since the two signal voltages developed cancel each other out.

The output of a push-pull amplifier must be matched to the load with which it is going to be used, so that there will be a maximum transfer of power. Output transformers are rated for both the primary and secondary impedances, and the impedance of the primary will be its rated value only when the secondary is terminated with its own rated impedance. Only under a matched condition is there maximum power output.

Some output transformers have specific impedances to which both the primary and secondary must be matched. If the secondary has a load connected to it which is lower in impedance than the rated value, the reflected impedance on the primary would be lower than its rated value, resulting in loss of power output. If the secondary has a load connected to it which is higher in impedance than the rated value, the reflected impedance on the primary would be higher than its rated value, also resulting in loss of power output.

Other output transformers are of the "universal" type. This type has a secondary winding with a number of taps. By selecting the proper taps on the secondary, you may properly match a variety of load impedances to the transformer and consequently get a maximum transfer of power from the amplifier to the load.



# MICROPHONES, EARPHONES AND LOUDSPEAKERS

## Principles of Sound

When it is desired to send an electric current from one point to another, wires are used to carry this current. When sound is sent directly from one point to another, it is the particles of air that carry the sound. In other words, in the transmission of electricity or sound, a medium must exist between the points of transmission; with electricity, wires are used, with sound, air is used.

Sound is actually the motion of pressure waves of air. Therefore, any device that produces sound, such as the human vocal cords, is a device for varying the pressure of the surrounding air. All musical instruments make use of this principle by having some part, such as a taut string, a reed or stretched membrane, which when set into vibration, produces varying pressure waves of air. In the piano, when a key is struck, a taut string is set into vibration. The string vibrates on both sides of its resting point and compresses and expands the surrounding air. When the string (see figure below) moves from its resting point to the right, the air to the right of the string is compressed (increased in pressure). When the string moves to the left of its resting point, the air to the right of the string will be expanded (reduced in pressure). If a sound detecting device, such as the human ear, is located in the vicinity of the vibrating string, the varying pressure waves will strike the eardrum and produce the sensation of sound.

The number of complete vibrations of the string occurring per second determines the frequency or pitch of the resulting sound wave. The intensity or amplitude of the sound wave is determined by the amount of displacement of the string from its resting point.

The sound produced by the human voice may vary in intensity in the ratio of 10,000 to 1 and cover a range of about 60 to 10,000 cycles. In music, the intensity variation may be as great as 100,000 to 1 and the frequency range is from about 40 to 15,000 cycles.

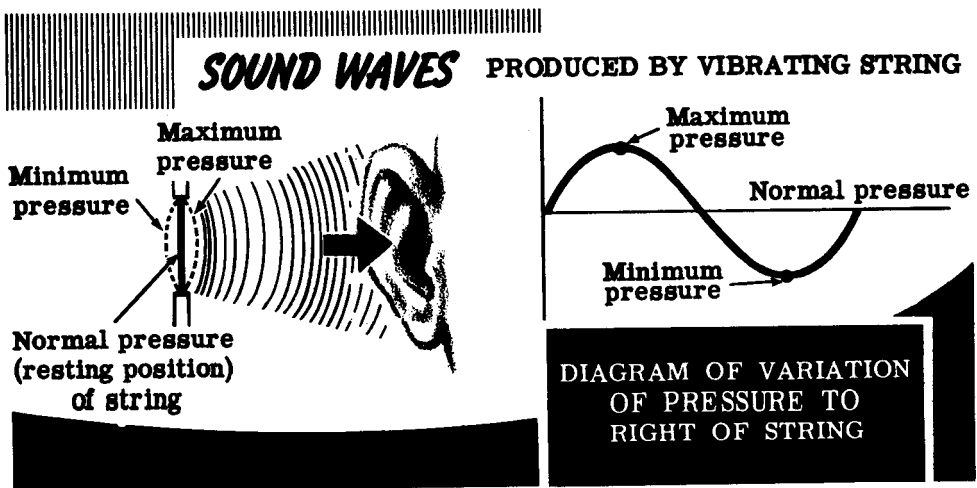

# MICROPHONES, EARPHONES AND LOUDSPEAKERS

## Characteristics of Microphones

The sound waves that you produce when you talk or sing can be converted into corresponding electrical impulses by the mechanism of a microphone. A diaphragm inside the microphone is actuated by the air pressure variations of the sound waves, and in turn causes the microphone to produce an AC voltage of the same frequency as the original sound. The amplitude of this AC voltage will be proportional to the intensity of the sound.

The ratio of electrical output (voltage) to the intensity of sound input is the sensitivity of a microphone. Sensitivity varies widely among different types of microphones. The electrical output of a microphone depends on the type of microphone and the distance between the microphone and the sound source. The output decreases as this distance is increased.

The frequency response of a microphone is a measure of its ability to convert different sound frequencies into alternating current. With a fixed sound intensity at the microphone, the electrical output may vary widely as the frequency of the sound source is varied. For clear understanding of speech, however, only a limited frequency range is necessary; from 200 to 4,000 cycles.

If the output of a microphone shows only small variations in amplitude between its upper and lower frequency limits, it is said to have a flat frequency response.

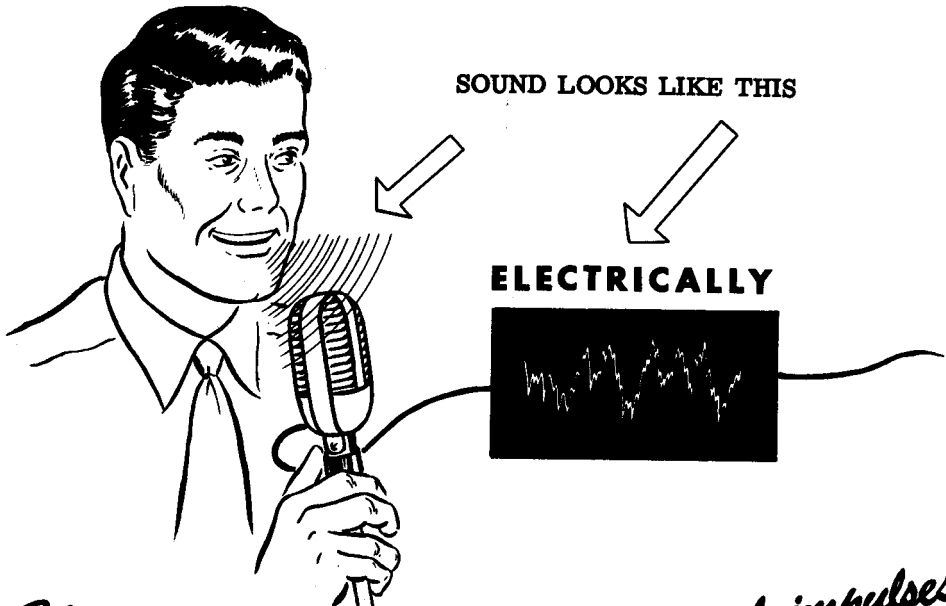

*Changing sound waves into electrical impulses*

You will study various types of microphones on the next few sheets.

# MICROPHONES, EARPHONES AND LOUDSPEAKERS

## The Carbon Microphone

The most common type of microphone, the carbon microphone, is restricted to a large extent to communications systems for the transmission of speech. This microphone is the most rugged of all the different types and supplies the largest output from a given sound input.

The figure below shows the principal parts of a single-button carbon microphone. This microphone operates by using the varying pressure waves of sound to vary the resistance between carbon granules. These carbon granules are sealed in a brass or carbon cup with an electrode that is mechanically connected to a thin diaphragm. The electrode acts as a plunger in compressing the carbon granules in the cup, which is often called a "carbon button." The carbon button is connected in series with a source of DC voltage and the primary of a microphone transformer.

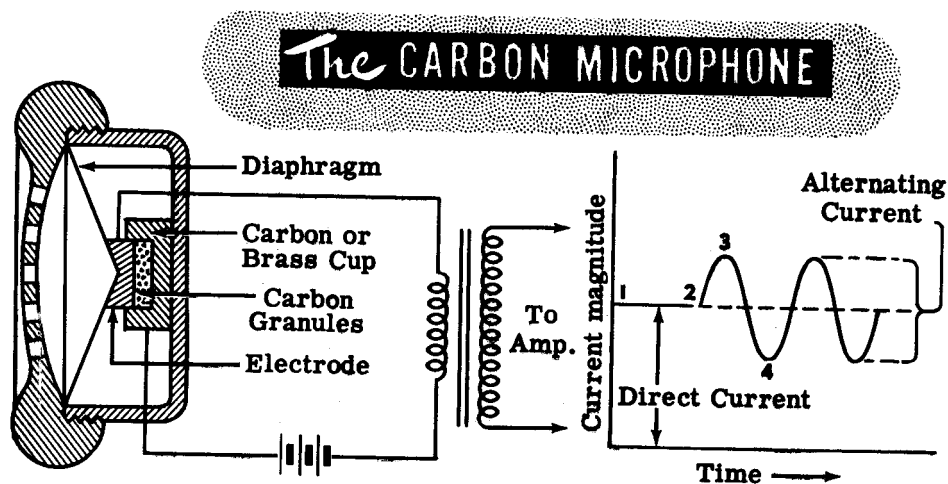

When no sound waves strike the diaphragm, the carbon granules are at rest. In this condition, the resistance of the carbon button, between the cup and the electrode, is constant and so is the circuit current. This is illustrated in the region from 1 to 2 in the illustration. When the pressure waves of sound strike the diaphragm, the diaphragm and the attached electrode move in and out, varying the pressure on the carbon granules. An increase in air pressure moves the diaphragm in, compressing the carbon granules and lowering their resistance. This causes the current to increase, which is shown in the region from 2 to 3 of the graph. A decrease in air pressure causes the diaphragm to move out which reduces the pressure on the granules raising their resistance and decreasing the circuit current. This is shown in the region from 3 to 4 of the graph.

In this manner, sound waves vary the circuit current in accordance with the sound pressure variations. These current variations through the primary of the transformer induce a stepped-up voltage in the secondary which is fed to the grid of an amplifier. The output of the amplifier can be connected to a loudspeaker or used to control the output of a radio transmitter.

The Crystal Microphone

One of the disadvantages of the carbon microphone is that it requires an external source of DC voltage for operation. In certain applications, a DC source for the microphone is not easy to obtain. In addition, the carbon granules may pack together due to the DC current arcing between them. This will eventually reduce the sensitivity of the microphone. Because the granules move around and cause tiny arcs when the microphone is handled, objectionable noise may appear in the output.

The crystal microphone eliminates all the difficulties encountered with the carbon microphone because it operates on a different principle and requires no external source of voltage.

Certain crystalline substances such as quartz and Rochelle salts, generate a voltage when pressure is applied. Remember, "How Pressure Produces Electricity" in Basic Electricity? This is known as the piezo-electric effect and this principle is used in crystal microphones.

The construction of a crystal microphone is shown below. The flat crystal of Rochelle salts (used instead of quartz because it is more sensitive) is mounted between two metal plates which have external connections. A thin diaphragm is mechanically connected to the crystal through a hole in the front plate. When the sound waves strike the diaphragm, varying pressure is applied to the crystal through the connecting pin and a varying voltage is produced between the plates. Since the sound waves apply the pressure to the crystal, the output voltage wave form will be an exact duplicate of the original sound.

The crystal microphone is a high impedance microphone and is connected directly to the grid of the amplifier without using a transformer.

*The* **CRYSTAL** *microphone*

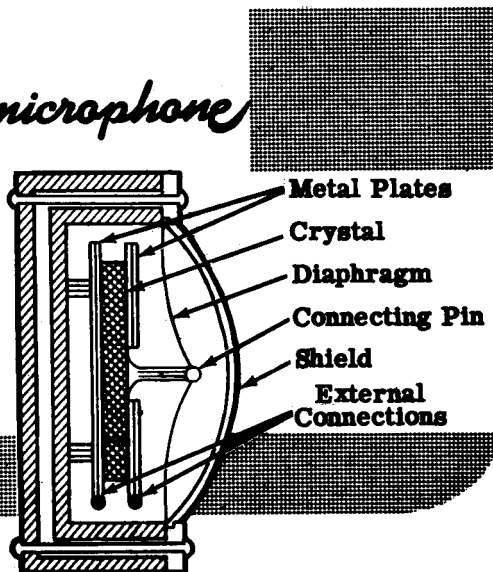
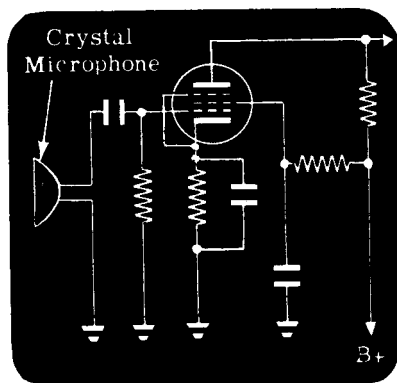



# MICROPHONES, EARPHONES AND LOUDSPEAKERS

## The Dynamic Microphone

In the dynamic or moving coil type of microphone, a coil of wire, which is rigidly attached to a diaphragm, is suspended in an air gap in which there is a very strong magnetic field. The magnetic field is produced by a permanent magnet. When the sound waves strike the diaphragm it moves back and forth with the coil. Since the coil is in the magnetic field, an AC voltage will be induced in it. This voltage will have the same wave form as the sound waves that strike the diaphragm.

The frequency of this AC voltage is the same as the frequency of the sound wave and the amplitude of the voltage is proportional to the sound wave's air pressure or intensity.

The dynamic microphone output feeds into a transformer which steps up the voltage and delivers a high impedance output so that it will work directly into the grid of an amplifier tube.

The dynamic microphone can be handled and moved during operation without producing undesirable noise in its output. It is dependable, requires no DC supply and has excellent frequency response between 20 and 9,000 cycles.

## The DYNAMIC MICROPHONE

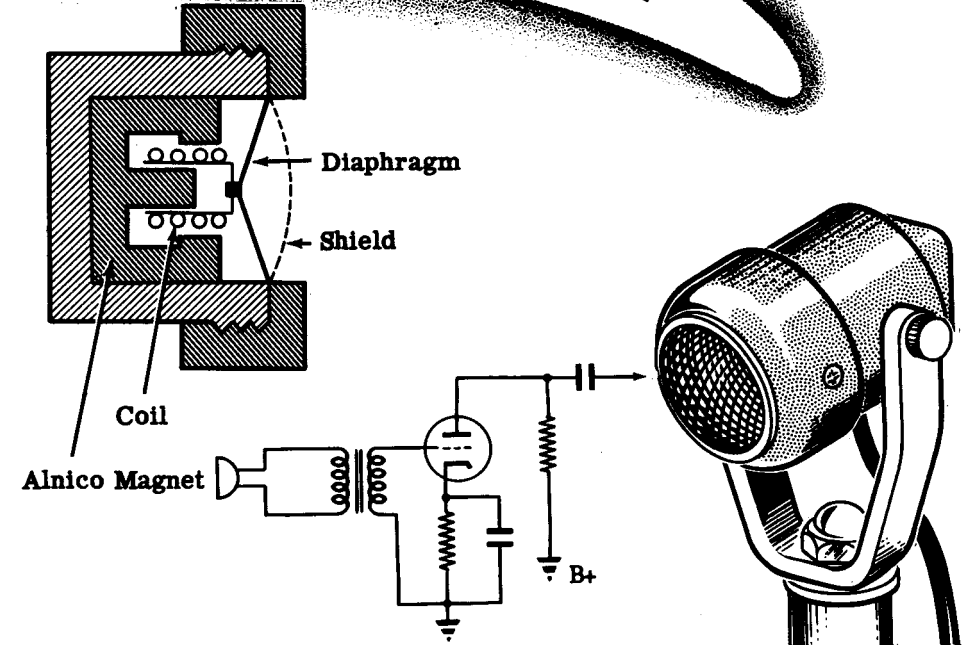

The Ribbon or Velocity Microphone

The ribbon microphone consists of a corrugated ribbon of aluminum alloy, which is suspended in a strong magnetic field so that the ribbon can be moved by the sound waves. As the sound waves move the ribbon back and forth, it cuts the lines of force between the poles of the magnets and a voltage is induced in the ribbon. This voltage is very small but it can be stepped up by a transformer, which is usually enclosed in the microphone casing. In addition to stepping up the voltage, the transformer raises the output impedance of the microphone so that it can be connected through a shielded cable to the grid of an amplifier.

The microphones described previously were pressure operated and had diaphragms which moved because the sound waves raised the air pressure on the front side of the diaphragm above the air pressure on the enclosed back side of the diaphragm. The ribbon microphone has no diaphragm and both front and back sides of the ribbon are exposed to the sound waves. The ribbon moves because of the small spaces between the ribbon and the pole pieces. The air passing through these spaces produces a difference in phase and pressure on the two sides of the ribbon. The voltage induced in the ribbon is determined not by the pressure of the air but by the velocity of the air particles traveling between the ribbon and pole pieces.

*The Ribbon Microphone*

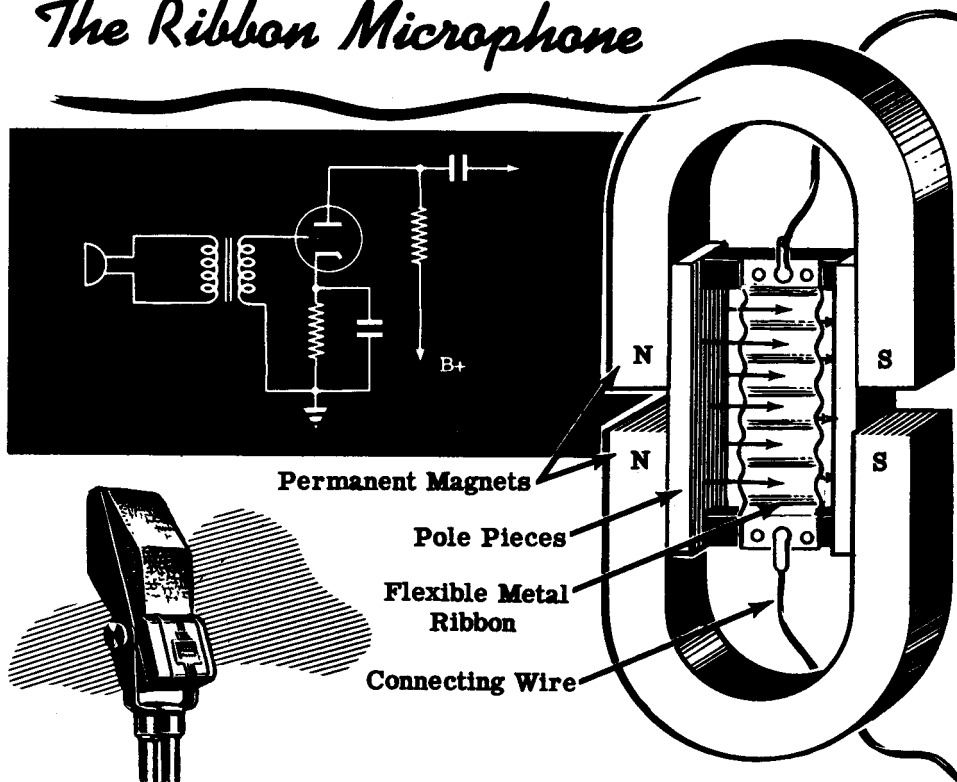

# MICROPHONES, EARPHONES AND LOUDSPEAKERS

## The Earphone

The purpose of a microphone is to convert sound pressure waves into corresponding AC voltages. The purpose of any sound reproducing device, such as an earphone or loudspeaker, is to change these AC voltages back into sound waves. To do this, the sound reproducer must be designed to vary the surrounding air pressure in accordance with the applied AC signal.

Earphones are used most often in communication systems where information is to be received but where high quality sound is not necessary. In some earphones, crystal elements are used. These earphones make use of the piezo-electric effect and act like a microphone in reverse. The amplified AC signal voltages are applied to the metal plates of a Rochelle salt crystal element, and these voltage variations cause the crystal to change its shape and produce pressure variations in the surrounding air, resulting in sound reproduction. The crystal earphones are light in weight and have excellent frequency response.

Most earphones operate on magnetic principles; a typical magnetic earphone is shown in the illustration below. A coil of fine wire is wound on each pole of a "U" shaped permanent magnet. These coils are usually connected in series and have external leads connected to the series combination. A soft iron diaphragm is held rigidly in place about one sixteenth of an inch away from the pole ends.

With no signal applied to the coils, the permanent magnet exerts a constant pull on the diaphragm. When the audio frequency (AC) currents flow through the coils, they become electromagnets. The magnetic fields that are produced by these coils are continuously reversing direction in accordance with the audio signal. At some instant the electromagnetic field will add to the permanent magnet's field and the diaphragm will be pulled in further, reducing the air pressure on the outer side. An instant later, the electromagnetic field will cancel some of the permanent magnet field and the diaphragm will move out beyond its normal position and compress the air in front of it. In this way the audio signal has been converted back into sound air pressure variations which, when striking the eardrum, produce sound.

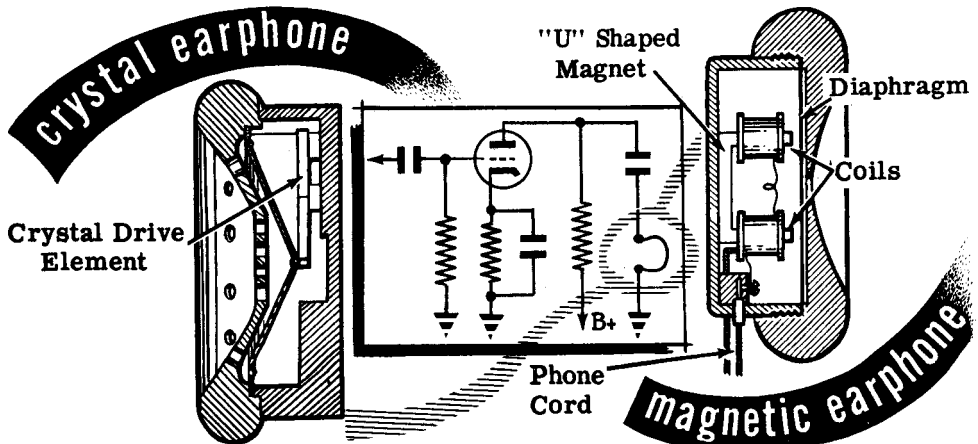

# MICROPHONES, EARPHONES AND LOUDSPEAKERS

## The Dynamic Loudspeaker

The dynamic loudspeaker is very similar in construction to the dynamic microphone. In fact, the permanent magnet type of speaker is sometimes used in intercommunication systems as both speaker and microphone.

Cross-sections of the permanent magnet dynamic speaker and the electro-magnet dynamic speaker are shown below. The construction of both types is exactly the same except for the method of obtaining the magnetic field. The electromagnetic type uses a field coil wound on a soft iron coil. A DC current is passed through the field coil and a strong magnetic field is produced in the air gap. In the permanent magnet type, a strong permanent magnet made of alnico alloy takes the place of the field coil. A coil of wire, which has relatively few turns, is suspended in the air gap and is attached to a paper cone. The outer edge of the cone and the voice coil suspension are corrugated and attached to the speaker frame. The corrugations allow the cone to move in and out freely.

The amplifier is connected to the voice coil through an output transformer which serves as an impedance-matching device. The AC audio signal current flowing through the voice coil causes it to generate a magnetic field whose polarity is continuously varying. When the voice coil field has a polarity that aids the field in the air gap, the voice coil and cone move in, reducing the air pressure in front of the cone. When the voice coil field is in opposition to the field in the air gap, the voice coil and cone are pushed out, compressing the air in front of the cone. In this way, audio signal currents are changed into sound pressure waves.

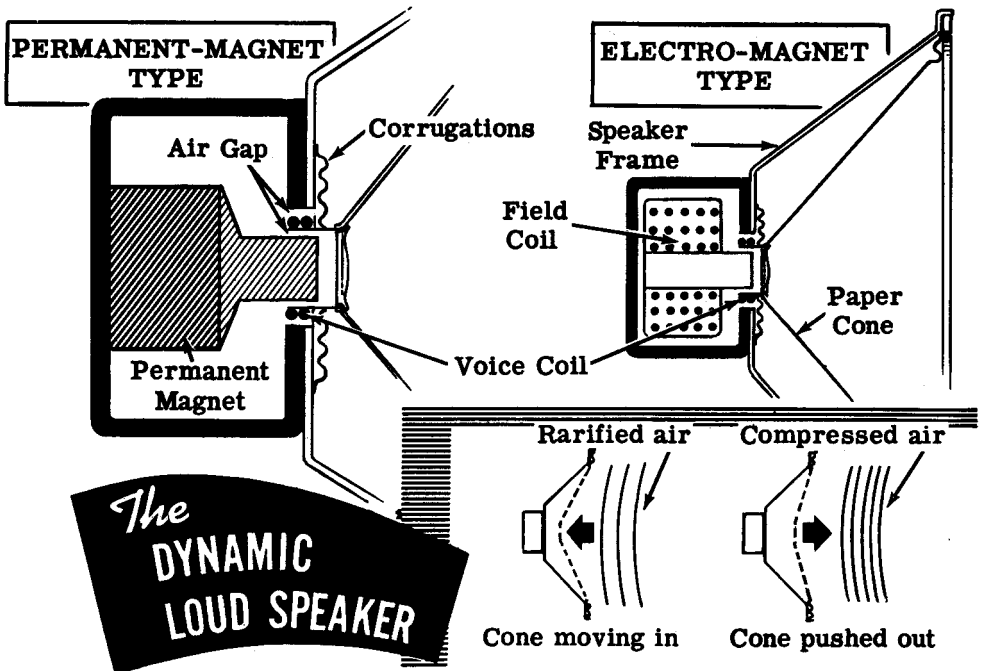

# MICROPHONES, EARPHONES AND LOUDSPEAKERS

## Review of Microphones, Earphones and Loudspeakers

**SOUND WAVES** are variations in air pressure produced by a vibrating solid body. The speed of vibration determines the pitch of the sound; the amplitude of vibration determines the loudness of the sound.

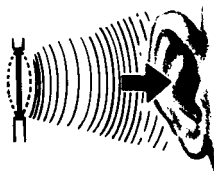

**MICROPHONES** change sound waves into electrical impulses. "Mikes" may be carbon, crystal, dynamic or ribbon type. The electrical impulses are fed into the grid of an amplifier either directly or through a step-up transformer.

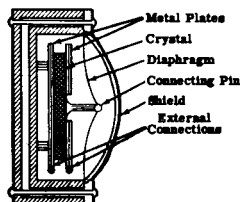
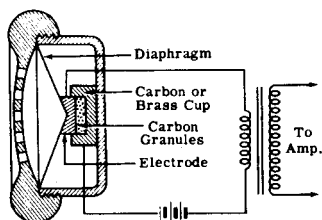

**EARPHONES** operate like microphones in reverse, and produce sound waves in response to electrical impulses. Both the crystal and magnetic earphones are widely used, the magnetic type being most common.

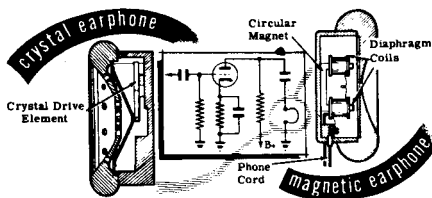

**LOUDSPEAKERS** are used where high quality sound reproduction is required. The dynamic loudspeaker operates like a dynamic microphone in reverse and may be of the permanent or electro-magnet type.

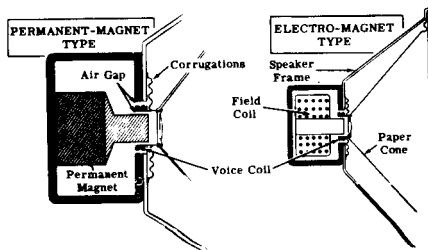

# AUDIO AMPLIFIERS

## Review of Audio Amplifiers

**AMPLIFICATION** — The process of changing a low AC input to a high AC output. A device which performs amplification is called an amplifier.

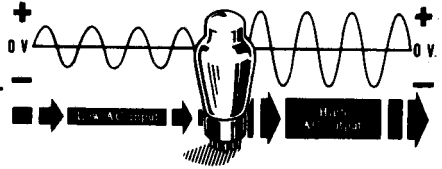

**THE TRIODE** — A vacuum tube similar to a diode but containing a grid which controls plate current between cathode and plate.

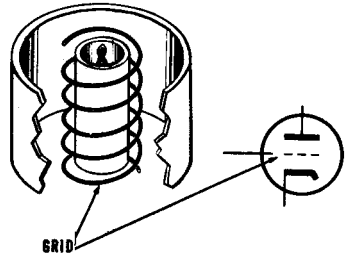

**TRIODE CHARACTERISTICS** — A plot of the variations in plate current as grid voltage changes; a measure of a triode's ability to amplify.

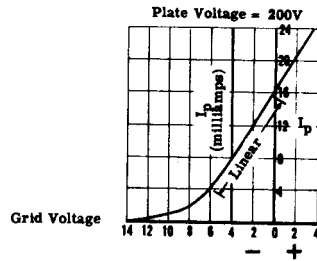

**GRID BIAS** — The amount of grid voltage determines the class of amplifier operation. In Class A the bias is less than cut off; in Class B bias is at or near cut-off; in Class C bias is much less than cut-off.

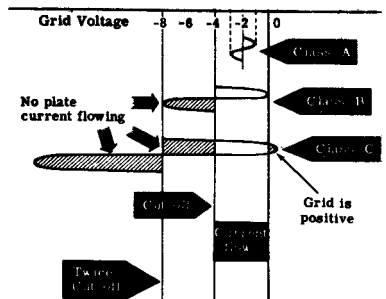

**TRIODE AMPLIFIER** — A simple circuit using a single triode with biasing components. This circuit is not used alone in actual equipment.

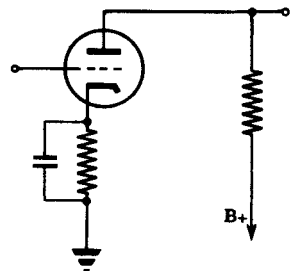

# AUDIO AMPLIFIERS

## Review of Audio Amplifiers (continued)

**THE PENTODE** — A tube which uses a suppressor grid and a screen grid between control grid and plate. It has greater amplification than the triode.

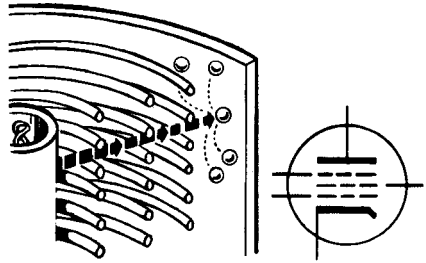

**SINGLE-STAGE AMPLIFIER** — A circuit consisting of a vacuum tube amplifier, biasing components, a load resistor, a decoupling network and a resistor and capacitor to provide coupling to another stage.

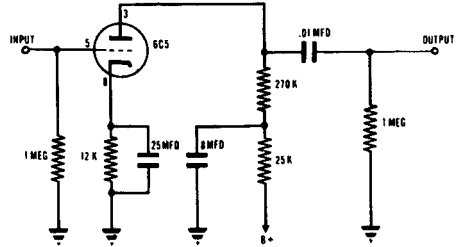

**TWO-STAGE RC-COUPLED AMPLIFIER** — A circuit consisting of two amplifier stages. The input to the grid of the second amplifier tube is the output from the first stage of amplification.

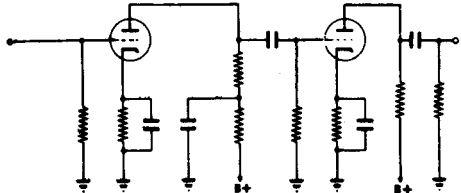

**TRANSFORMER-COUPLED AMPLIFIER** — A two-stage amplifier identical to the two-stage RC-coupled amplifier except that a transformer is used to couple the first and second stages.

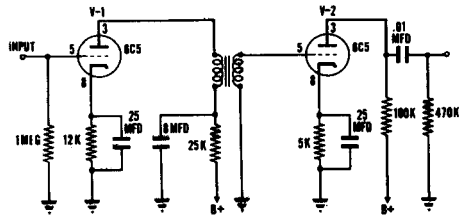

**VOLTAGE GAIN** — The total amplification of a two-stage (or multistage) amplifier is the product of the amplifications of each stage. The ratio of the output voltage of the final stage to the input voltage to the first stage is called the gain of the amplifier.

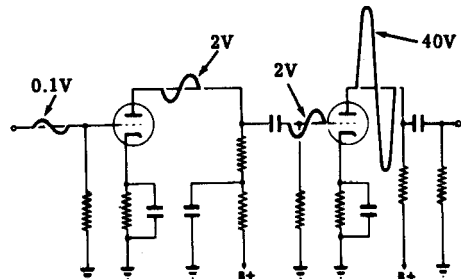

# AUDIO AMPLIFIERS

## Review of Audio Amplifiers (continued)

**AUDIO POWER AMPLIFIER** — An amplifier designed to supply power to a load. Its input is the output of a voltage amplifier stage. Its output feeds a load through an output transformer.

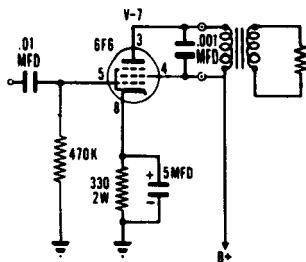

**PHASE INVERTER** — A circuit which uses one or two vacuum tubes to produce two signal voltages 180 degrees out of phase. It is also called a phase splitter and replaces the transformer in a push-pull circuit.

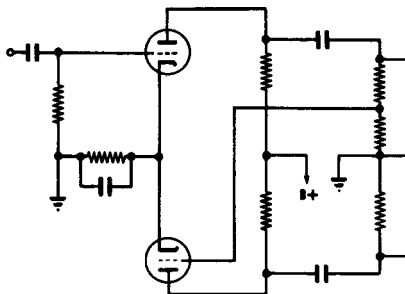

**PUSH-PULL POWER AMPLIFIER** — A circuit consisting of a voltage amplifier, a phase splitter (inverter), two power amplifier tubes and an output transformer.

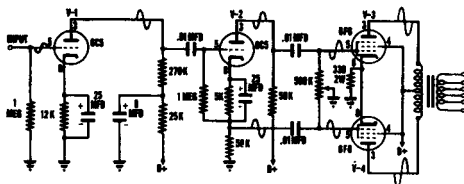

**THE OUTPUT TRANSFORMER** — A transformer used to couple the power amplifier output to the load. It matches the low load impedance to the high impedance required by the amplifier.

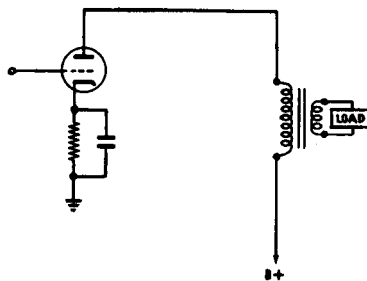

**MICROPHONES, EARPHONES AND LOUDSPEAKERS** — Carbon, crystal, dynamic and ribbon microphones are used to change sound waves into electrical impulses. Earphones and loudspeakers change electrical impulses to sound waves.

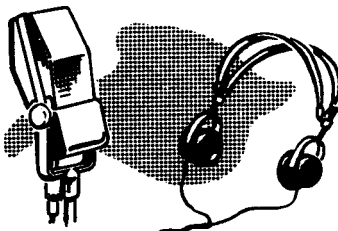



## INDEX



## INDEX TO VOL. 2

(Note: A cumulative index covering all five volumes in this series will be found at the end of Volume 5.)

- Amplification, examples of, 2-1 to 2-3
- Amplifiers, 2-1 to 2-10
  - advantages of push-pull type, 2-85
  - characteristics of audio power type, 2-71 to 2-73
  - characteristics of transformer-coupled type, 2-69, 2-70
  - characteristics of the two-stage type, 2-60, 2-61
  - classes of, 2-30, 2-31
  - diagram of push-pull type, 2-84
  - how they work, 2-17 to 2-19
  - how the push-pull type works, 2-78 to 2-80
  - single-stage, 2-55 to 2-57
  - push-pull type, 2-78 to 2-86
  - transformer coupled, 2-67 to 2-70
  - triode type, 2-24 to 2-41
  - two-stage RC coupled type, 2-58 to 2-66
  - typical stage, 2-55
- Beam power tube, 2-50, 2-51
  - construction of a typical tube, 2-51
- Bias, B+ power supply, 2-34
  - battery, 2-32
  - cathode, 2-35
  - grid voltage, 2-24 to 2-26
  - power supply, 2-33
- Cathode bypass capacitor, 2-38 to 2-40
- Cathode resistor, 2-36, 2-37
- Coupling, amplifier stages, 2-59
  - transformer, 2-67, 2-68
- Decoupling filters, 2-56, 2-57
- Earphones, 2-93
- Frequency response, 2-62 to 2-64
  - curve, 2-65
- Gain, increase of, 2-58
- Impedance matching, 2-76, 2-77
- Loudspeakers, dynamic type, 2-94
- Microphones, 2-88 to 2-92
  - carbon, 2-89
  - characteristics of, 2-88
  - crystal, 2-90
  - dynamic type, 2-91
  - ribbon or velocity type, 2-92
- Output transformers, 2-74 to 2-77
  - job of, 2-74, 2-75
- Pentodes, 2-47 to 2-49, 2-52, 2-53
  - construction of a typical tube, 2-49
  - how they work, 2-48
  - summary of operation of, 2-52, 2-53
- Phase inverters, 2-81 to 2-83
  - another type of, 2-83
  - how they work, 2-82
- Review, Audio Amplifiers, 2-96 to 2-98
  - Microphones, Earphones and Loudspeakers, 2-95
  - The Push-Pull Amplifier, 2-86
  - The Tetrode and the Pentode, 2-54
  - The Triode, 2-23
  - The Triode Amplifier, 2-41
  - The Two-Stage RC Coupled Amplifier, 2-66
- Sound, principles of, 2-87
- Tetrodes, 2-42 to 2-46
  - eliminating effects of secondary emission, 2-47
  - normal operation of, 2-46
  - screen grid, 2-43
  - secondary emission in, 2-44
  - static characteristics of, 2-45
  - why they were developed, 2-42
- Triodes, 2-11 to 2-23
  - construction of typical tube, 2-12
  - control grid in, 2-14, 2-15
  - how they work, 2-13
  - similarity to the diode, 2-16
- Triode amplifiers, why proper bias is necessary, 2-27 to 2-29
- Triode tube characteristics, amplification factor, 2-20
  - plate resistance, 2-21
  - transconductance, 2-22
- Vacuum tubes, amplification, 2-11
  - how they were developed, 2-8, 2-9
  - types of, 2-6, 2-7
  - what they can do, 2-4, 2-5







## HOW THIS OUTSTANDING COURSE WAS DEVELOPED:

In the Spring of 1951, the Chief of Naval Personnel, seeking a streamlined, more efficient method of presenting Basic Electricity and Basic Electronics to the thousands of students in Navy speciality schools, called on the graphiological engineering firm of Van Valkenburgh, Nooger & Neville, Inc., to prepare such a course. This organization, specialists in the production of complete "packaged training programs," had broad experience serving industrial organizations requiring mass-training techniques.

These were the aims of the proposed project, which came to be known as the Common-Core program: to make Basic Electricity and Basic Electronics completely understandable to every Navy student, regardless of previous education; to enable the Navy to turn out trained technicians at a faster rate (cutting the *cost* of training as well as the time required) without sacrificing subject matter.

The firm met with electronics experts, educators, officers-in-charge of various Navy schools and, with the Chief of Naval Personnel, created a dynamic new training course . . . completely up-to-date . . . with heavy emphasis on the visual approach.

First established in selected Navy schools in April, 1953, the training course comprising Basic Electricity and Basic Electronics was such a tremendous success that it is now the *backbone* of the Navy's *current* electricity and electronics training program!\*

The course presents one fundamental topic at a time, taken up in the order of need, rendered absolutely understandable, and hammered home by the use of clear, cartoon-type illustrations. These illustrations are the most effective ever presented. *Every page has at least one such illustration—every page covers one complete idea!* An imaginary instructor stands figuratively at the reader's elbow, doing demonstrations that make it easier to understand each subject presented in the course.

Now, for the first time, Basic Electricity and Basic Electronics have been released by the Navy for civilian use. While the course was *originally* designed for the Navy, the concepts are so broad, the presentation so clear—*without* reference to specific Navy equipment—that it is ideal for use by schools, industrial training programs, or home study. *There is no finer training material!*

"Basic Electronics" consists of *five* volumes, as follows: *Vol. 1*—Introduction to Electronics, Diode Vacuum Tubes, Dry Metal Rectifiers, What a Power Supply Is, Filters, Voltage Regulators. *Vol. 2*—Introduction to Amplifiers, The Triode Tube, Tetrodes & Pentodes, Audio Voltage & Power Amplifiers. *Vol. 3*—Video Amplifiers, RF Amplifiers, Oscillators. *Vol. 4*—Transmitters, Transmission Lines & Antennas, CW Transmission & Amplitude Modulation. *Vol. 5*—Receiver Antennas, Detectors & Mixers, TRF Receivers, Superheterodyne Receivers.

\*"Basic Electricity," the first portion of this course, is available as a separate series of volumes.

**JOHN F. RIDER PUBLISHER, INC., 116 WEST 14th ST., N. Y. 11, N. Y.**



No. 170-3

# basic electronics

by **VAN VALKENBURGH,  
NOOGER & NEVILLE, INC.**

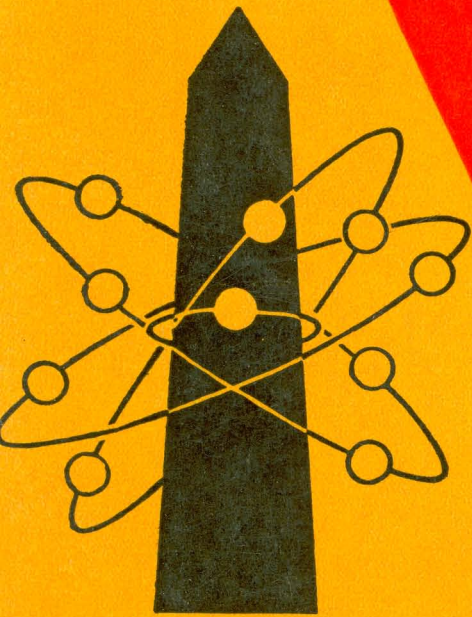

**VOL. 3**

VIDEO AMPLIFIERS  
RF AMPLIFIERS  
OSCILLATORS

A. STICH

a **RIDER** publication



\$2.25

# **basic electronics**

**by VAN VALKENBURGH,  
NOOGER & NEVILLE, INC.**

**VOL. 3**



**JOHN F. RIDER PUBLISHER, INC.**  
116 West 14th Street • New York 11, N. Y.

**First Edition**

*Copyright 1955 by*

**VAN VALKENBURGH, NOOGER AND NEVILLE, INC.**

**All Rights Reserved under International and Pan American Conventions. This book or parts thereof may not be reproduced in any form or in any language without permission of the copyright owner.**

*Library of Congress Catalog Card No. 55-6984*

**Printed in the United States of America**

## PREFACE

The texts of the entire Basic Electricity and Basic Electronics courses, as currently taught at Navy specialty schools, have now been released by the Navy for civilian use. This educational program has been an unqualified success. Since April, 1953, when it was first installed, over 25,000 Navy trainees have benefited by this instruction and the results have been outstanding.

The unique simplification of an ordinarily complex subject, the exceptional clarity of illustrations and text, and the plan of presenting one basic concept at a time, without involving complicated mathematics, all combine in making this course a better and quicker way to teach and learn basic electricity and electronics.

In releasing this material to the general public, the Navy hopes to provide the means for creating a nation-wide pool of pre-trained technicians, upon whom the Armed Forces could call in time of national emergency, without the need for precious weeks and months of schooling.

Perhaps of greater importance is the Navy's hope that through the release of this course, a direct contribution will be made toward increasing the technical knowledge of men and women throughout the country, as a step in making and keeping America strong.

*Van Valkenburgh, Nooger and Neville, Inc.*

*New York, N. Y.*

*February, 1955*

## TABLE OF CONTENTS

### VOL. 3 — BASIC ELECTRONICS

Video Amplifiers . . . . .	3-1
Introduction to the RF Amplifier . . . . .	3-15
Tuned Circuits . . . . .	3-19
A Single-Stage RF Amplifier . . . . .	3-28
The Two-Stage RF Amplifier . . . . .	3-35
Introduction to Oscillators . . . . .	3-43
The Armstrong and Hartley Oscillators (includes Colpitts) . . . . .	3-55
The Tuned-Plate Tuned-Grid and Crystal Oscillators . . . . .	3-66
The Electron-Coupled Oscillator . . . . .	3-74
Miscellaneous Oscillators . . . . .	3-78

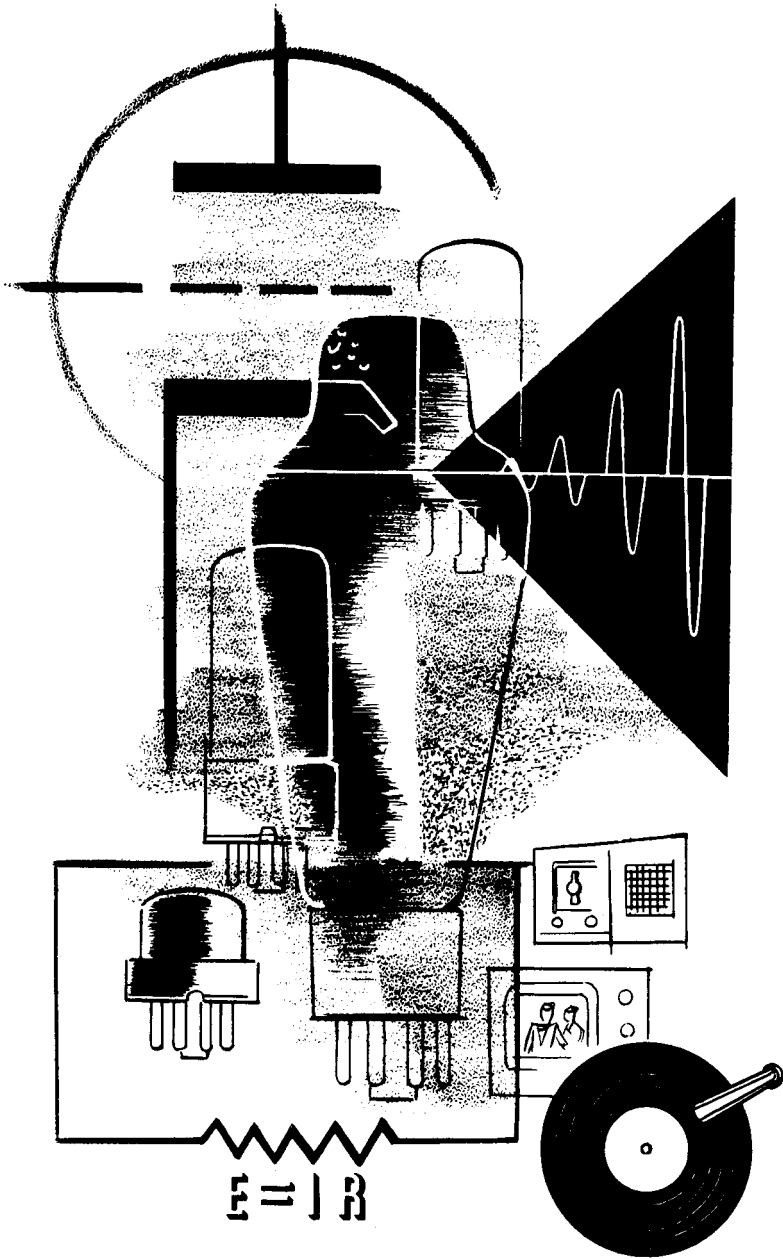

*Video Amplifiers*



# VIDEO AMPLIFIERS

## Introduction to Video Amplifiers

Video amplifiers are very similar to the RC-coupled audio amplifiers you have already seen. One very important difference between them is this—video amplifiers are designed to amplify odd-looking wave forms which an ordinary audio amplifier would distort. Some of the wave forms that video amplifiers are required to handle are called "pulses" or "square waves".

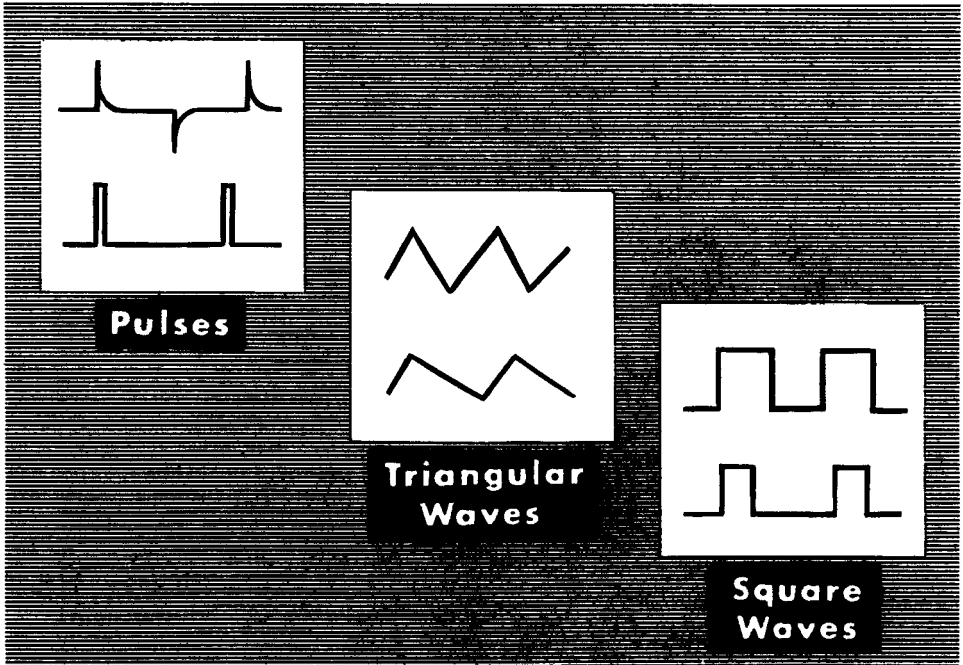

A French mathematician, Fourier, showed that such wave forms can be considered to be the sum of many sine waves of different frequencies. Some of the sine waves that the mathematicians say can be found in a square wave are ten times higher in frequency than the square wave itself. Therefore, the amplifier that is needed to amplify the square wave without distortion must have a frequency range covering the frequency of the square wave (fundamental) and the frequencies (harmonics) of all the other sine waves which make up the square wave.

However, all this about harmonic frequencies does not mean that you will need an advanced course in mathematics in order to understand video amplifiers. The mathematician can go right on defining a video amplifier as a wide-band amplifier capable of amplifying sine wave signals in the frequency range of from 30 cycles all the way up to several million cycles (megacycles) per second. You can look at it in a much simpler, and just as accurate, way. A video amplifier must be able to amplify signals such as square waves without adding distortion. Simple? If you put a square wave into a video amplifier you should get a square wave output. If not, something is wrong with the amplifier.

You will find video amplifiers used wherever square waves or pulses are to be amplified without distortion.

## VIDEO AMPLIFIERS

### Introduction to Video Amplifiers (continued)

To many of you, the word "video" is synonymous with television and it should, therefore, come as no surprise to you to learn that video amplifiers are used in television receivers. The picture is sent out by the station as a series of electrical pulses which represent dark and light portions of the picture. These pulses are received in the home by the TV antenna, amplified by the video amplifier and applied to the picture tube so as to duplicate the picture sent out by the station.

In television, the characteristics of the picture depend in part on the quality of the video amplifier. If the amplifier distorted the pulses, the picture would lack the sharpness and the detail it would otherwise have.

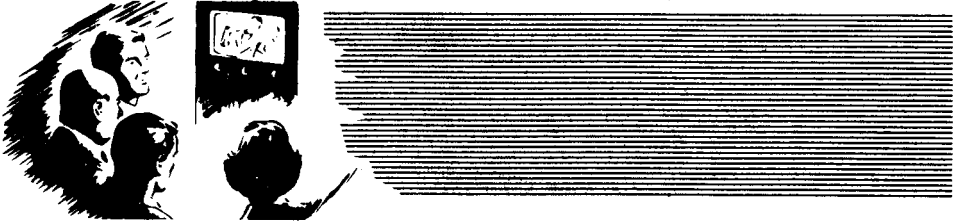

Another important application of video amplifiers is in the oscilloscope. In a 'scope, the vertical amplifier must amplify the input signal without adding any distortion. If the input signal is a distorted sine wave or a square wave, that is how it is supposed to appear on the 'scope screen if the 'scope is to do its job. Therefore a video amplifier is used as the vertical amplifier in a 'scope because video amplifiers are capable of amplifying almost any wave form without distortion.

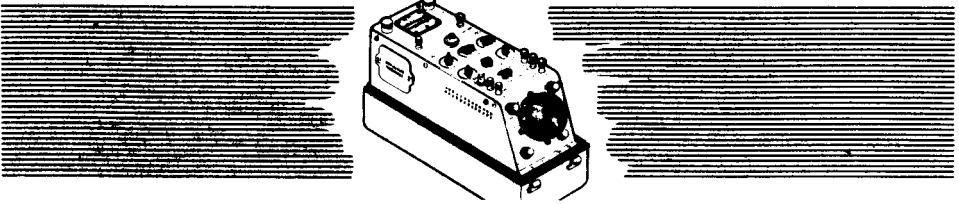

One of the very important applications of video amplifiers is in radar equipment. Every radar, whether it is used for search or for fire control, contains a video amplifier. Radar echoes are sharp pulses and the amplifier must preserve the shape of these echoes so that the radar operator can obtain accurate information about the target that is sending back the echo.

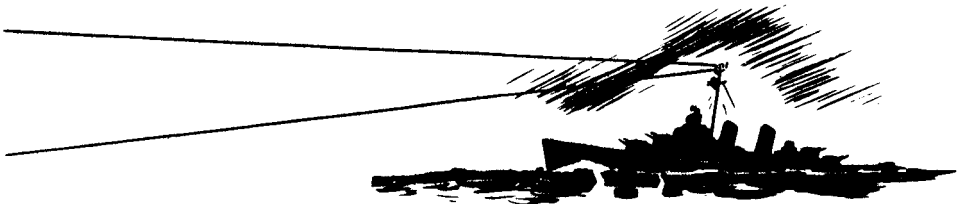

Only video amplifiers can be used where pulses or square waves are to be amplified without distortion. No other amplifier comes close to meeting the requirements for the video amplifiers in oscilloscopes, television, sonar, radar, teletype, loran and photo facsimile equipment.



## VIDEO AMPLIFIERS

### Distortion of Square Waves

One reason that a square wave would be distorted in an audio amplifier is the amplifier's poor low frequency response. This shows up in the output as an unfaithful reproduction of the flat portion of the square wave.

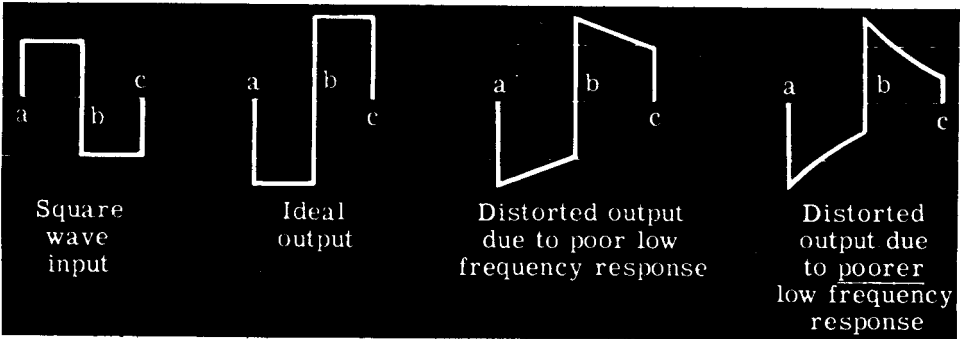

This is what happens in the amplifier. During the flat portion of the square wave between time (a) and time (b) the grid voltage, the plate current and the plate voltage remain constant. At time (b), the grid voltage drops suddenly to a new value and the plate voltage rises just as suddenly to its new value.

When this happens, current will flow through R-2 in the direction shown, causing the output voltage to appear across this resistor. The amount of current that flows in R-2 depends, of course, on the value of the plate voltage, on the voltage across the coupling condenser and on the value of R-2. This current will be small if R-2 is large but, however small the current is, it will still charge up C-1 and thereby change the voltage across the condenser. As the voltage across C-1 increases, the current through R-2 decreases, resulting in the distorted output shown above.

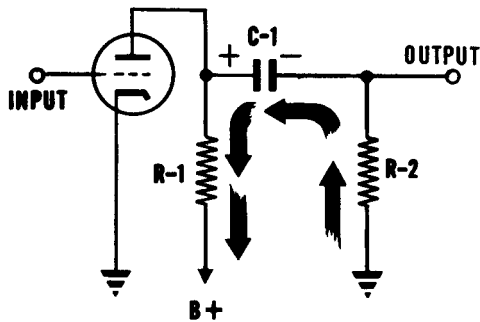

If C-1 has a small value, the same amount of current flow will cause its voltage to change by a greater amount and the output will be more distorted. Further distortion will take place if R-2 is decreased. This will result in greater current flow through the coupling condenser and a greater change in voltage across it. To improve the low frequency response of an RC-coupled amplifier and thereby reduce the distortion that occurs in the flat portion of the square wave, R-2 and C-1 should be as large as possible.

## VIDEO AMPLIFIERS

### Distortion of Square Waves (continued)

Even with good low frequency response, there might be a cause for distortion. This cause, as you may have guessed, would be poor high frequency response. This distortion appears in the output as an unfaithful reproduction of the steep portions of the square wave.

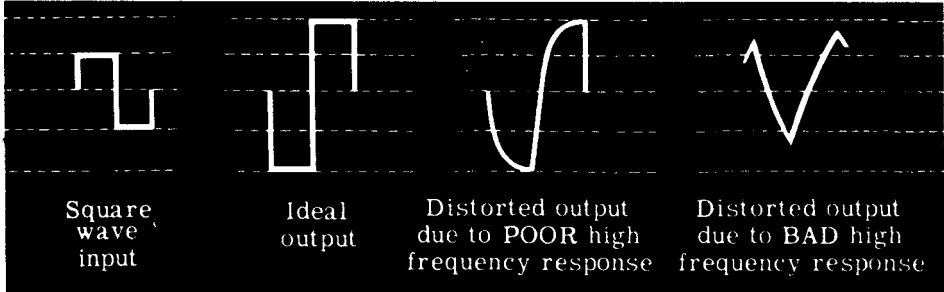

The stray capacitance,  $C-2$ , is the cause of this distortion. It cannot change its voltage instantaneously and, since  $C-2$  is directly across the output, the output voltage cannot change instantaneously either. The stray capacitance,  $C-2$ , can charge and discharge through  $R-1$  and  $R-2$  which are in parallel. If the parallel combination of  $R-1$  and  $R-2$  allows  $C-2$  to charge and discharge quickly, the output will show little or no distortion. If  $R-1$  and  $R-2$  are large resistances,  $C-2$  will require a relatively long time to charge and discharge and the steep sides of the square wave will not be perfectly vertical. The larger these resistances become, the worse the distortion becomes. When this becomes very severe,  $C-2$  will never be able to charge and discharge enough to reach the flat portion of the square wave and the output will resemble the triangularly shaped wave shown above.

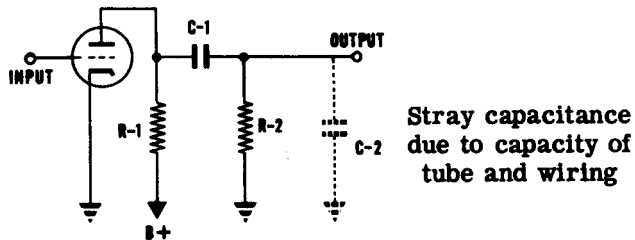

If you recall the discussion about improving the high frequency response of audio amplifiers, you will remember that there are two different ways of doing this. The first is to reduce the stray capacitances  $C-2$  by using special amplifier tubes with very low values of input and output capacitance and by using special wiring techniques to reduce the stray capacitance between the wires and ground. The second way is to reduce the time it takes  $C-2$  to charge and discharge. This is done by using lower values of  $R-1$  and  $R-2$ .

As you know, reducing  $R-2$  would harm the low frequency response. Therefore this is not done. Reducing  $R-1$  reduces the gain of the stage but this disadvantage is overcome in video amplifiers by adding more stages, each with low gain but good frequency response. Special tubes are used such as the 6AC7, 6SH7 and the 6AG7. These tubes are designed for high gains and low input and output capacitances and are, therefore, ideally suited for video amplifiers.

## VIDEO AMPLIFIERS

### Compensating Networks—High-Frequency Compensation

One common way of improving wave shapes in video amplifiers is to decrease the effect of the things which cause distortion. This includes adjusting the values of R and C in the coupling network so as to reduce distortion. You have already seen how this works. Another way is to introduce just the opposite distortion into the circuit by adding compensating networks which counteract the distortion that is already there.

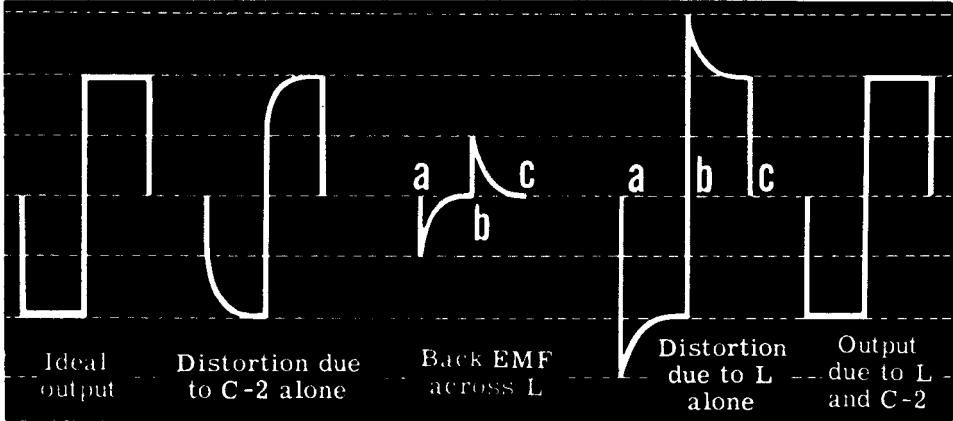

To improve the steepness of the steep portion of the square wave, an inductance ( $L$ ) is placed in series with the plate load resistor ( $R-1$ ). The back emf set up in this inductance every time the plate current changes will be in such a direction as to cause a peak to appear in the plate voltage.

At (a), the grid voltage is swinging positive and the plate current increases. The plate voltage decreases and at the same instant, a back emf is set up across  $L$ . This back emf tends to oppose the increase of current and has the direction shown in the diagram. This negative back emf lowers the plate voltage below its normally low value, thus causing a peak to appear on the square wave.

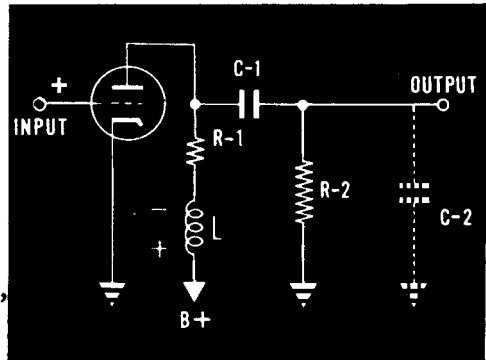

When the grid voltage swings negative, as at (b), the plate current decreases and the back emf across  $L$  is in the opposite direction. This then adds to the plate voltage—normally high anyway—causing another peak to appear at (b). Because of the effect of this inductance, it is always referred to as a "peaking coil."

Now consider the effect of these peaks on the charging and discharging of  $C-2$ , the stray capacitance.  $C-2$  will now tend to charge to higher values of voltage—higher because of the peaks—and to discharge to lower values of voltage. This will cause  $C-2$  to charge and discharge faster than it would if no peaking coil were used. If the proper value of  $L$  is used, the final output can be made an almost perfect square wave.

## VIDEO AMPLIFIERS

### Compensating Networks—Low-Frequency Compensation

The most common compensating circuit used for correcting low frequency distortion is one that resembles a decoupling network. Like the peaking coil, this circuit introduces a distortion that is opposite, and so counter-balances the distortion due to other causes.

The distortion this circuit compensates for is the distortion of the flat region of the square wave caused by the voltage changes across the coupling condenser. This is how this circuit accomplishes its purpose:

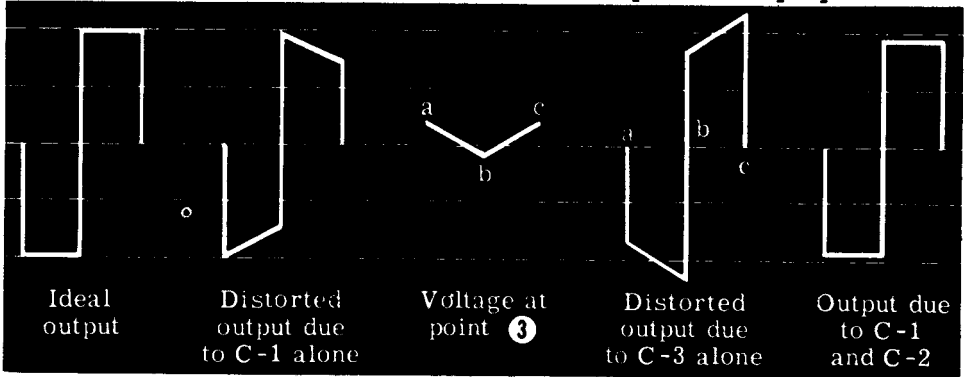

At (a), the plate current increases, the voltage drop across the R-1 increases, and the voltage drop across R-3 (in the compensating network) tends to increase. The voltage at point 1 in the circuit tends to decrease as a result. The condenser C-3 will discharge and the voltage at point 1 will decrease as the condenser discharges. Thus, the plate voltage will continue to decrease between time (a) and time (b). (Now, the voltage across the coupling condenser can change during this time, and the voltage across the grid resistor R-2 will remain constant.)

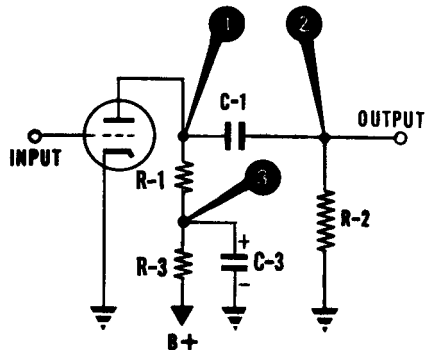

Low-Frequency  
Compensating Network

At (b), the current suddenly decreases and the voltage at point 1 rises as the condenser C-3 charges up. Thus between time (b) and time (c), the plate voltage is increasing.

Let's see what happens to the flat portion of the square wave in the output. Without the compensating network, the voltage across the coupling condenser changed and this change, subtracted from the steady plate voltage, leaves a distorted voltage across R-2. With the compensating network, the voltage across the coupling condenser still changes, but these changes subtract not from a steady plate voltage but from a plate voltage that is itself changing in an opposite direction. In a properly designed circuit, the voltage across R-2 will be an almost perfect square wave.

## VIDEO AMPLIFIERS

### Improving Frequency Response—Degeneration

If there were no compensating circuits used, distortion would appear in the output. Let's say that a perfect square wave (wave form 1) is connected to the grid of an amplifier, and that the output is distorted as shown in wave form 2.

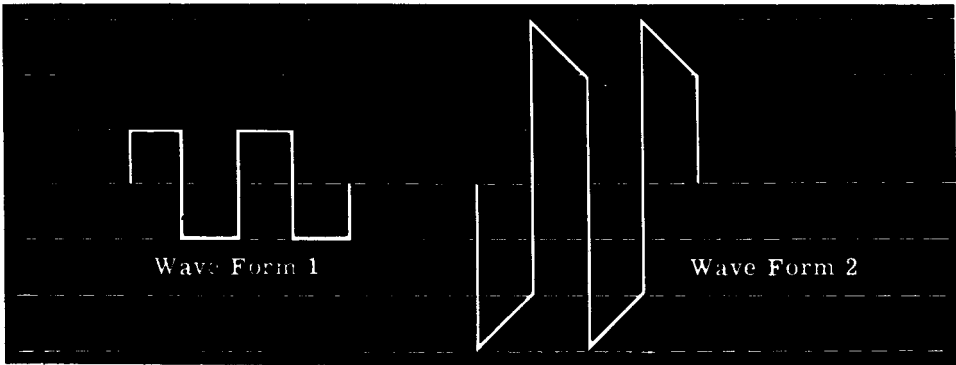

Now let's take a small part of the output wave form (as in wave form 3) and bring it back to the input. The resulting input would be the sum of the original input and this voltage which is fed back from the output. The new input will look like wave form 4.



The new voltage at the plate of the amplifier will be wave form 5 which, you will notice, has just the opposite distortion than existed when the input was a perfect square wave. Whatever was causing distortion before is still causing it now, with the result that the output is still distorted but not nearly so much as it was previously. Compare wave form 6 (the new output) with wave form 2 (the old output).

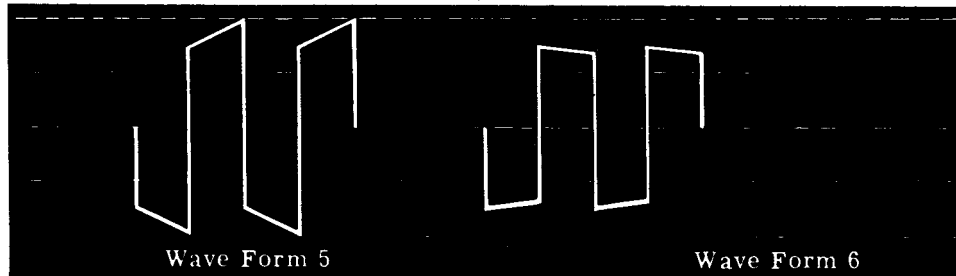

You will notice that the new input wave form (no. 4) is smaller than wave form 1, the old input. This is so because the voltage that was fed back is out of phase with, and so subtracts from, the original signal input. Thus the output is smaller than it would ordinarily be and the gain of the stage is apparently lessened. More important than the loss of gain is the decrease in the amount of distortion. This method of decreasing distortion is known as "degeneration" or as "negative feedback."

## VIDEO AMPLIFIERS

### Improving Frequency Response—Degeneration (continued)

There are several ways of obtaining negative feedback. One of the simplest and most widely used methods is to have the cathode bias resistor, R-4, unbypassed. In this way the cathode voltage will not be pure DC but will vary as the current varies. When the grid goes positive (or less negative), the cathode current increases and the cathode voltage goes positive. This cathode voltage decreases the grid-to-cathode signal and so lowers the gain of the stage. Furthermore, the cathode current will not be of the same wave shape as the grid voltage if distortion is present in the circuit. The cathode voltage will contain this distortion and the difference between the grid and the cathode voltages will contain just the opposite distortion. This reduces the distortion in the output.

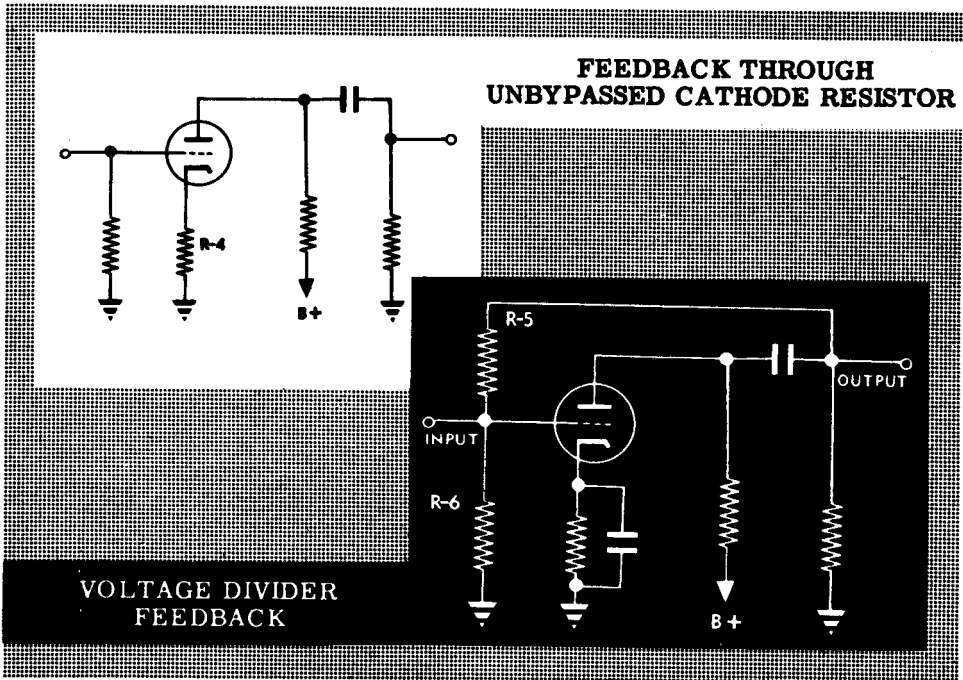

Another way of obtaining negative feedback is to use a voltage divider consisting of R-6, the grid resistor, and R-5. This voltage divider is connected across the output so that part of the output voltage appears across R-6. In addition, the input signal appears across R-6. Since the output and input signals are 180 degrees out of phase, the resultant input signal to the grid will be the difference between the input to the stage and that part of the output signal that is fed back. This, of course, will counteract part of the distortion in the output.

In each of these two circuits, it is possible to adjust the amount of signal that is fed back. If the unbypassed cathode resistor, R-4, is increased or, in the other circuit, if R-5 is decreased the feedback will be increased. Increasing the feedback lowers the gain of the stage and makes the output signal resemble the input signal more closely.

## VIDEO AMPLIFIERS

### Improving Frequency Response—Degeneration (continued)

Degeneration works equally well for all types of distortion. In the illustrations shown on the previous sheet, you saw how degeneration improves the response of the amplifier to the flat portion of the square wave. Below, you see the six wave forms that explain how degeneration improves the steepness of the steep portion of the square wave. As before, wave form 1 is the original input to the grid; wave form 2 is the signal that would appear in the output if no negative feedback were used; wave form 3 is the part of output signal that is fed back and appears between grid and cathode; wave form 4 is the resultant grid-to-cathode signal; wave form 5 is the amplified resultant grid voltage as it appears on the plate; and wave form 6 is the new output voltage—reduced in height but with much less distortion than wave form 2.

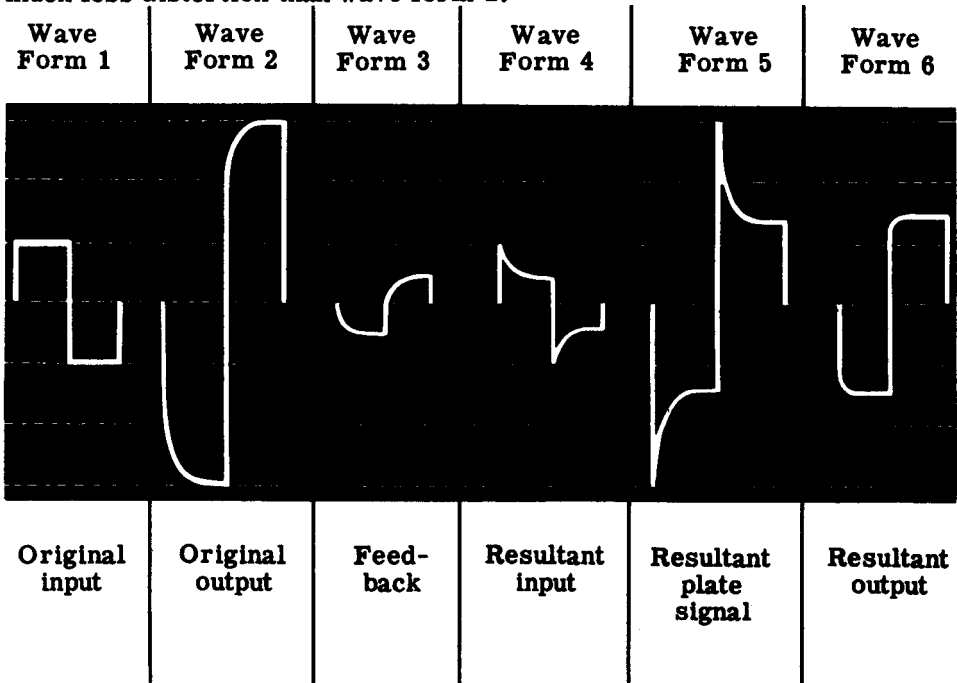

The important thing to remember is that the signal which is fed back contains the distortion that exists in the output. When this signal is combined with the original grid signal, the distortion appears "backward." The resulting plate signal has distortion that is opposite to the distortion originally existing in the output. In this respect, negative feedback does almost the same thing as a compensating network. The important differences are these:

1. Negative feedback will reduce any type of distortion while a compensating network will work only for the type of distortion it is designed to eliminate.
2. Negative feedback will always result in decreased gain.

# VIDEO AMPLIFIERS

## Review of Video Amplifiers

**VIDEO AMPLIFIER** amplifies pulses, triangular or square waves, without distortion, whereas an audio amplifier distorts these wave forms due to poor high and low frequency response.

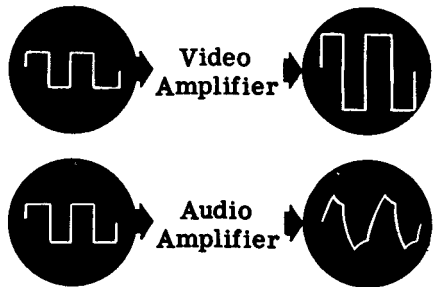

**LOW FREQUENCY RESPONSE** can be improved by increasing capacity of the coupling capacitor and by adding a low frequency compensating network.

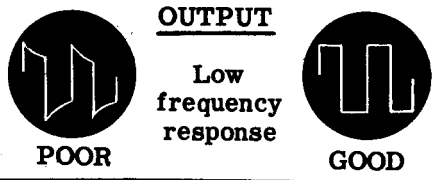

**LOW FREQUENCY COMPENSATING NETWORK** develops a varying voltage, which, when added to the square wave input voltage, counteracts the distortion of flat portion of square wave due to the coupling capacitor.

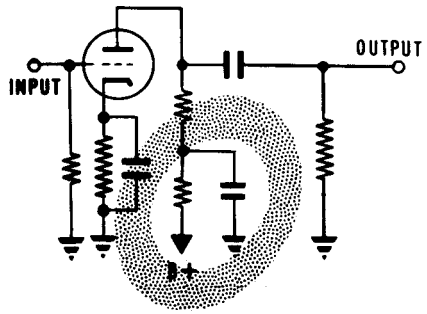

**HIGH FREQUENCY RESPONSE** can be improved by reducing the value of the plate load resistor and by adding a peaking coil in the plate lead.

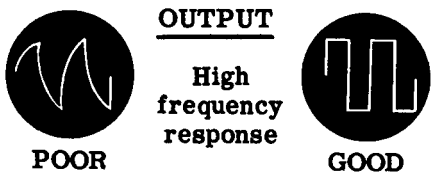

**PEAKING COIL** counteracts the effect of stray capacitance, which tends to round off the leading edge of the square wave.

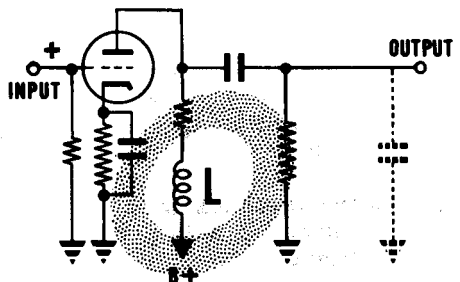



# VIDEO AMPLIFIERS

## Review of Video Amplifiers (continued)

**DEGENERATION** or negative feedback is a method of overcoming any type of square wave distortion by returning part of output as a grid signal. Resultant output contains very little distortion.

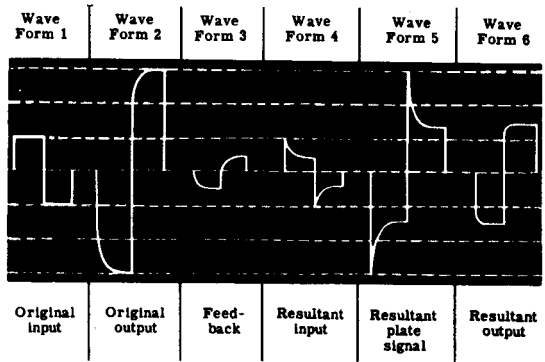

**UNBYPASSED CATHODE RESISTOR** provides degeneration by forcing the cathode voltage to vary as the current varies, introducing distortion opposite to, and thus reducing, that present.

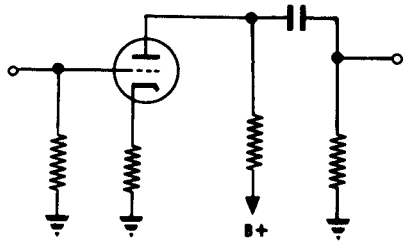

**VOLTAGE DIVIDER FEED-BACK** introduces part of the output voltage across the grid but 180 degrees out of phase, so that distortion is introduced in reverse and thus reduced.

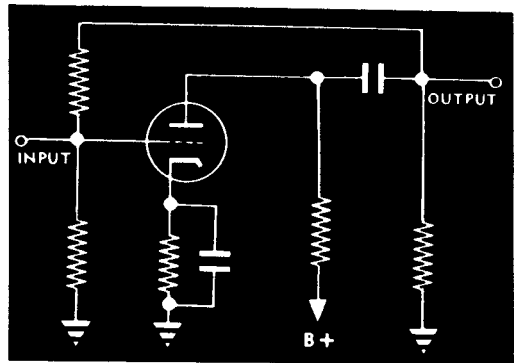

**VIDEO AMPLIFIER CIRCUIT** may contain all or several of the distortion-reducing components.

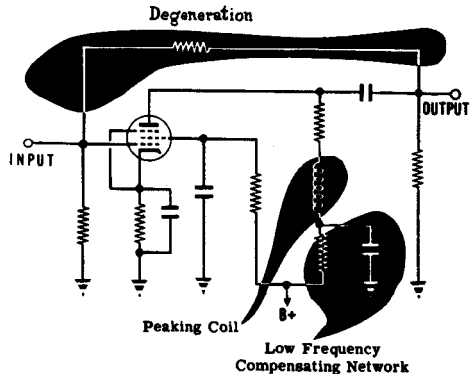



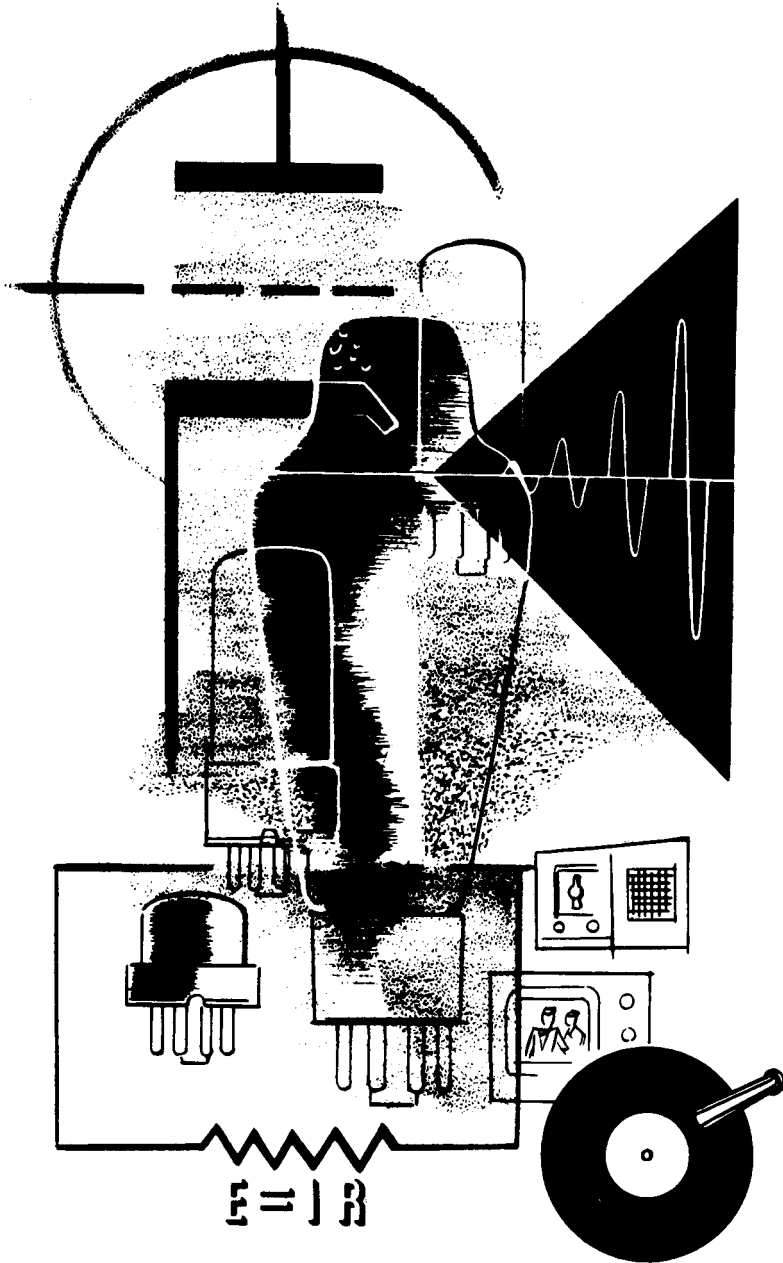

## RF *Amplifiers*



# INTRODUCTION TO THE RF AMPLIFIER

## Amplifiers and Amplification

In order to understand what an RF amplifier is, you ought to review amplifiers and amplification. An amplifier is an electronic device which uses vacuum tubes to build up an AC voltage. Suppose you need 10 volts to drive a pair of headphones or a loudspeaker and the signal voltage is only 0.1 volts, which is too small to be used. This signal is fed into the grid of an amplifier tube which builds it up to 1.0 volts. Then you feed the 1.0 volt into another amplifier tube and it gives 10 volts output.

You have the alternative of using one amplifier tube with a gain of 100 and building up the voltage to 10 volts in one step. When two tubes are used to do the job, it is called a two-stage amplifier. When one is used, it is a single-stage amplifier. Some amplifiers use as many as 5 stages to build up a voltage large enough to drive a piece of equipment.

### TWO STAGE Amplifier

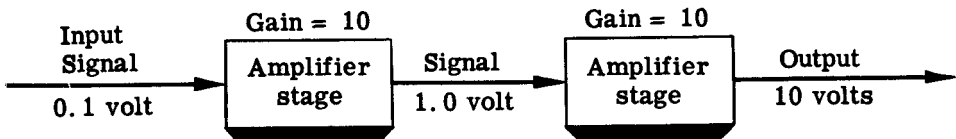

### SINGLE STAGE Amplifier

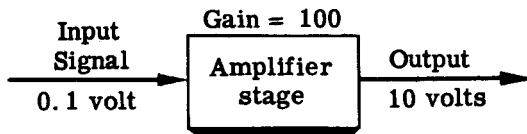

When an amplifier builds up the voltage 10 times, it has a voltage gain of 10. The voltage gain is the number of times a stage or group of stages amplifies the signal.

# INTRODUCTION TO THE RF AMPLIFIER

## What an RF Amplifier Does

Now you are ready to examine what makes an RF amplifier different from other types of amplifiers. You remember that:

1. Audio amplifiers amplify all frequencies from about 15 to 15,000 cycles per second.
2. Video amplifiers amplify all frequencies from about 30 to 6,000,000 cycles per second.

### FREQUENCY RANGES OF AMPLIFIERS

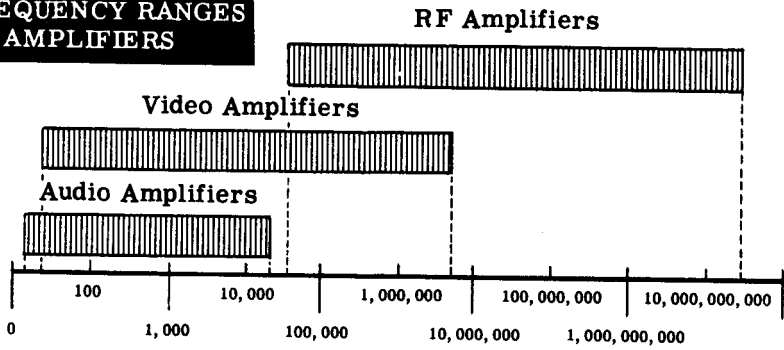

RF amplifiers amplify signals from about 30,000 to 30,000,000,000 cycles per second. The outstanding feature of an RF amplifier is that it does not amplify this entire frequency range at once. It selects one small portion—the portion occupied by the radio signal sent out by one transmitter—and amplifies that. For instance, WCBS broadcasts at a frequency of 880 kilocycles and is allotted a band whose limits are 5 kilocycles either side of 880. Most standard broadcast stations are allotted a band 5 kc either side of a center frequency. When you tune a broadcast receiver to WCBS you are adjusting the RF amplifier to select the band of frequencies extending from 875 to 885 kc.

The same principle applies to short wave and television stations. For example, a station at 10 mc might have a bandwidth from 9.8 to 10.2 mc. A perfect RF amplifier would select that range of frequencies and reject all others. Television channel 2 occupies the band from 54 to 60 mc. When you tune a television set to channel 2 you are adjusting the RF amplifier to select that band and reject all others.



## INTRODUCTION TO THE RF AMPLIFIER

### What an RF Amplifier Does (continued)

You already know that a signal sent out by a radio transmitter travels through the air to reach your radio, sometimes for thousands of miles. The transmitter may be putting out thousands of watts of power, but when the signal reaches your receiver it may be very weak. The signal coming into your receiver is usually in the order of a few millionths of a volt and must be amplified many times before it will drive a loudspeaker or earphones.

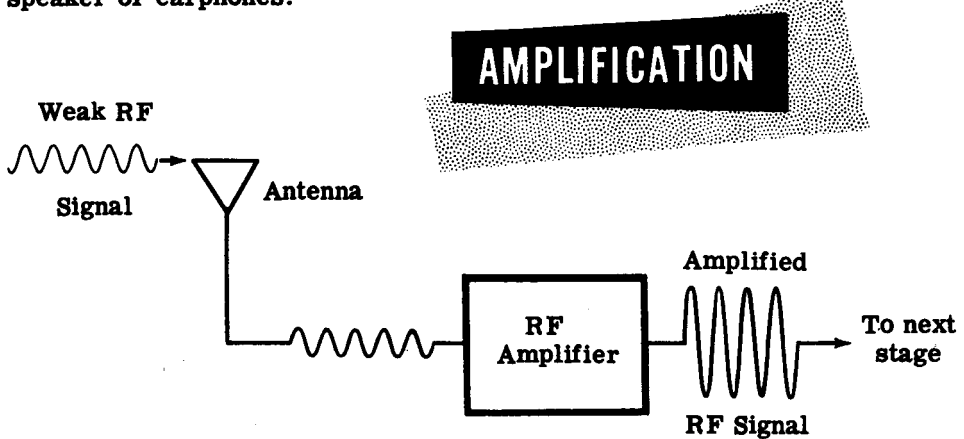

It is possible to amplify a radio signal in several different ways. You may amplify it at radio frequency as it comes from the antenna, or you may convert it to lower radio frequencies or even audio frequency and then amplify it. These various methods will be discussed later in Volume 5 under Radio Receivers. The important point is that amplification is not the only function of an RF amplifier. The most important thing an RF amplifier does is to separate the stations whose signals reach the radio receiver. This process is called "tuning." When you tune a receiver or a transmitter or a radar unit, you are changing the frequency to which the RF amplifier is set.

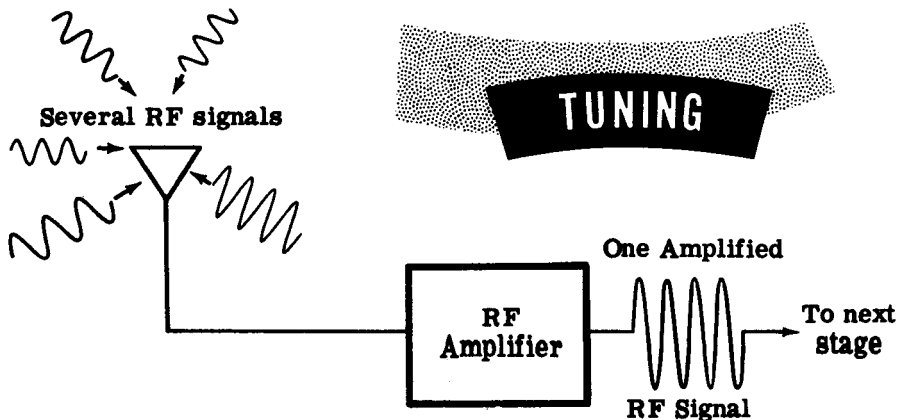

# INTRODUCTION TO THE RF AMPLIFIER

## This Is What You Will Learn about RF Amplifiers

Before you learn more about RF amplifiers, you will have a brief review of resonance. In addition to what you learned about coils and capacitors in Basic Electricity, you will be shown how the resonant effect is used to tune an RF amplifier stage. The selectivity of tuned circuits and "Q" will be explained and you will be shown the construction of antenna and RF coils actually in use.

After the section on resonant circuits, you will see why pentodes are nearly always used as RF amplifiers. Then you will be shown actual RF amplifier circuits illustrating how you may connect the tuned circuits to the amplifier tube and how the correct voltages are applied to the tube. You will go through an analysis of every part used in a typical RF amplifier stage in a broadcast receiver, and find out how using more than one RF amplifier stage affects selectivity.

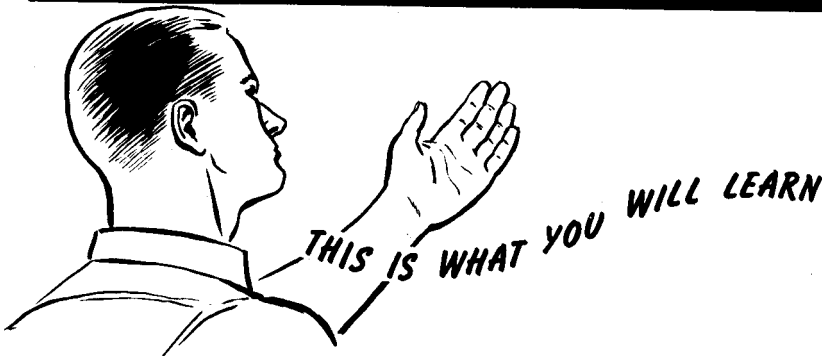
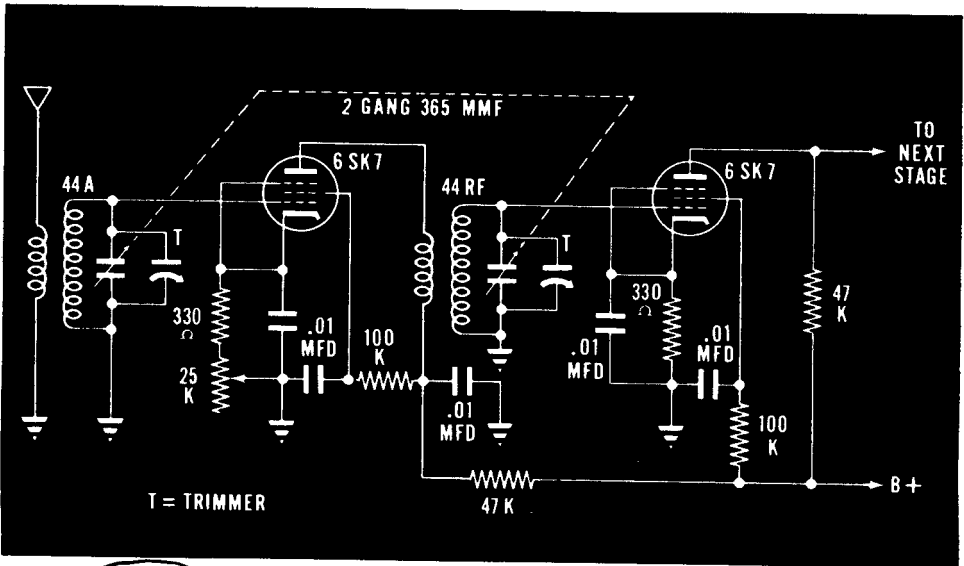



## TUNED CIRCUITS

### What a Tuned Circuit Is

From the introduction to RF amplifiers, you learned that all RF amplifiers perform two important functions:

1. They amplify the signal at radio frequencies.
2. They select one narrow band of frequencies and reject all others.

Amplification of the signal is accomplished by a vacuum tube, just as in audio and video amplifiers. You have already learned just about all you need to know about amplification.

The job of selecting one narrow band of frequencies to be amplified is performed by the RF amplifier's "tuned circuit." The tuned circuit consists of coils and capacitors connected to form a resonant LC circuit, which is "tuned" to the desired frequency. On the following sheets you will see how tuned circuits work in RF amplifiers.

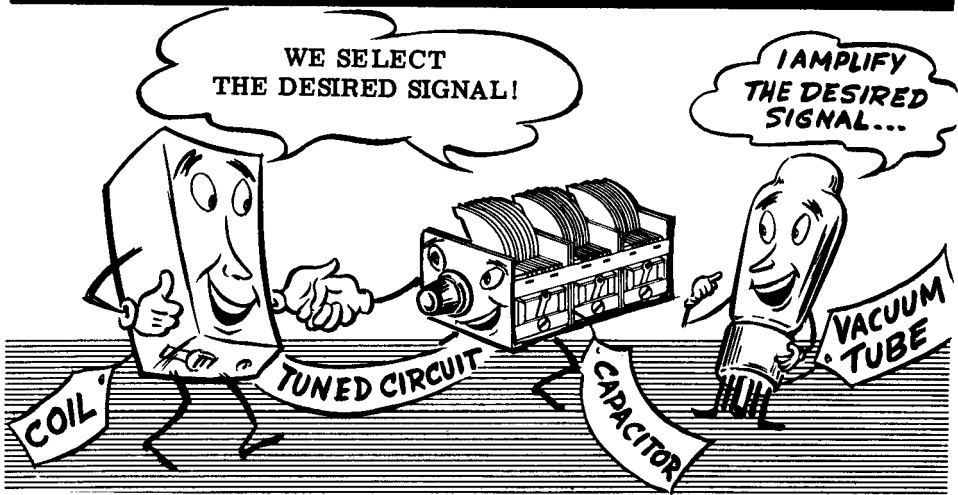
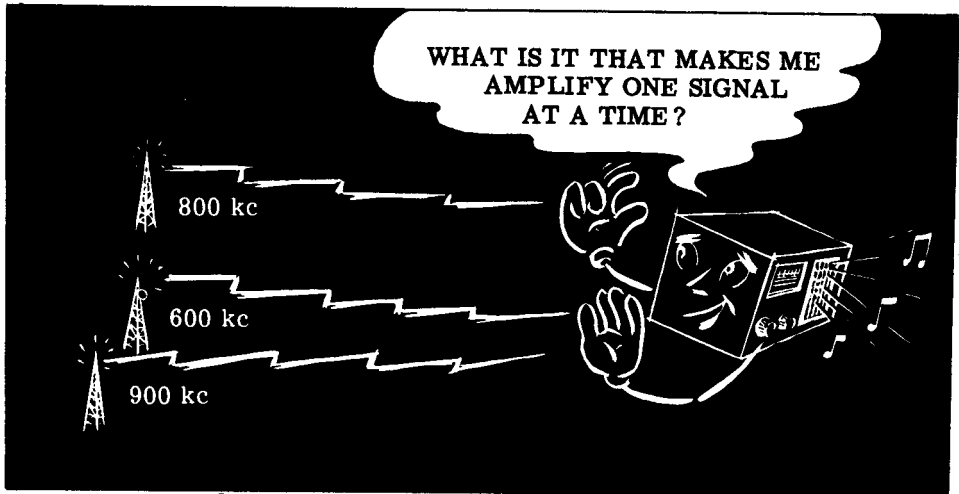

# TUNED CIRCUITS

## Review of Series LC Circuits

In a radio receiver there are many signals of different frequencies coming into the antenna. The listener tunes the radio by adjusting the tuning capacitor. This makes the antenna coil and capacitor resonate to the frequency of the desired station. Because of the resonant effect, the coil and capacitor select only that signal tuned to their resonant frequency. In order to understand exactly what the resonant effect is, let's review series LC circuits and then parallel LC circuits.

You remember that a coil offers less opposition to low frequencies than to high ones. A capacitor offers less opposition to high frequencies than to low ones. This opposition is called reactance.

**REACTANCE CURVES OF A COIL AND CAPACITOR**

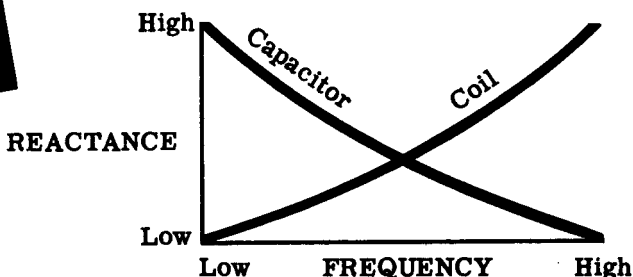

In the series LC circuit shown below, assume that the signal generator is delivering a very low frequency. The coil will offer little opposition to this low frequency, but the capacitor will offer very high opposition. Therefore very little current will flow, because the total reactance of the circuit is high. On the other hand, if the signal generator delivers a very high frequency, the coil will offer very high opposition, and the current will still be low. At some intermediate frequency the reactance of the coil will equal the reactance of the capacitor. At this frequency (the resonant frequency), the impedance of the circuit will be minimum and the current will be maximum.

**Below Resonant Frequency**

High reactance  
Low reactance

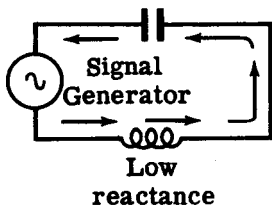

**Above Resonant Frequency**

Low reactance  
High reactance

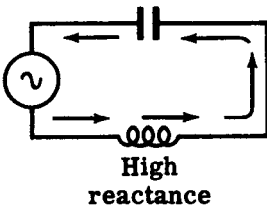

**At Resonant Frequency**

Both reactances equal, cancel each other

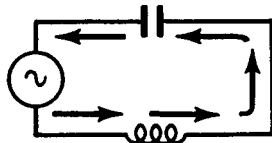

# TUNED CIRCUITS

## Review of Parallel LC Circuits

Most radio receivers employ parallel-resonant rather than series-resonant circuits for tuning to different frequencies.

The reactance of coils and capacitors varies with the frequency applied to them, as you saw on the previous sheet. In addition to this, coils and capacitors have another property which is important in resonant circuits. A coil causes the current to lag behind the applied voltage by 90 degrees. A capacitor causes the current to lead the applied voltage by 90 degrees.

### VOLTAGE AND CURRENT WAVE FORMS ACROSS A COIL

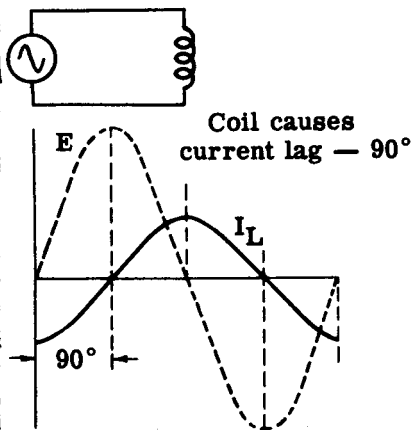

### VOLTAGE AND CURRENT WAVE FORMS ACROSS A CAPACITOR

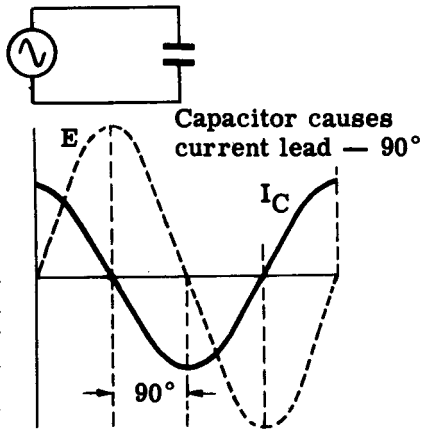

If you connect a coil in parallel with a capacitor, the current in the coil is 90 degrees behind the applied voltage plus 90 degrees behind the current in the capacitor, or, a total of 180 degrees out of phase with the capacitor current. You remember from Basic Electricity that currents which are 180 degrees out of phase cancel one another. If the capacitor alone draws 3 amps and the coil alone draws 2 amps, then the combination of the two will draw 3 - 2 or 1 amp.

### CAPACITOR AND COIL IN PARALLEL

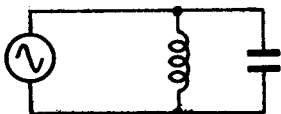

$I_L$  180° out of phase with  $I_C$

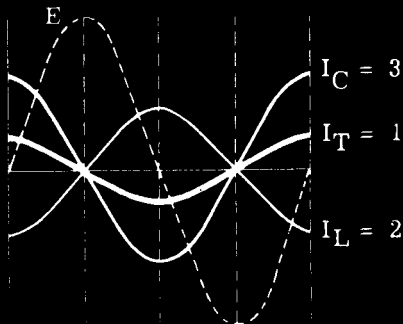

# TUNED CIRCUITS

## Review of Parallel LC Circuits (continued)

Since the coil and capacitor are in parallel, the voltage across them is the same. If you choose a frequency at which the reactance of the coil equals the reactance of the capacitor and feed this frequency into them, the current in the coil will be equal and opposite to the current in the capacitor. Then no current will flow through the combination of the two. The frequency at which this occurs is called the resonant frequency, and it is at this frequency that the tuned circuit's impedance is greatest.

### *In Theory*

AT RESONANT FREQUENCY THE EXTERNAL CURRENT = 0

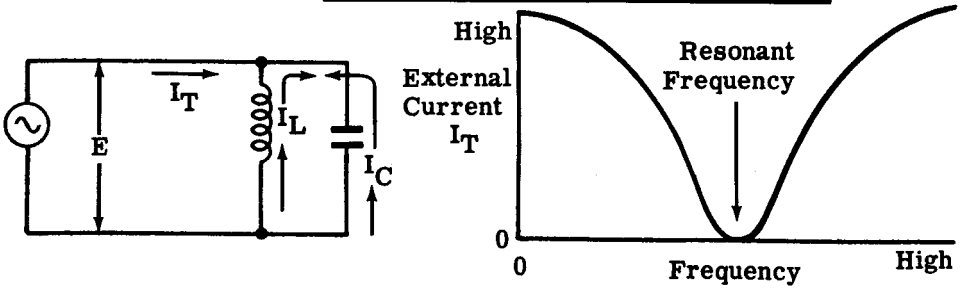

If you saw an electrical device which had a voltage across it but conducted no current, you would call it an open circuit. You would say it had infinite impedance. In theory, the parallel-resonant circuit has infinite impedance; in practice, this is never quite true. There is always a little current flowing in the external circuit, even at the resonant point. This is because all real coils have some resistance. As a result, the current in the coil is not quite 180 degrees out of phase with the current in the capacitor, and they don't cancel each other out completely.

### *In Practice*

AT RESONANT FREQUENCY THE EXTERNAL CURRENT IS MINIMUM

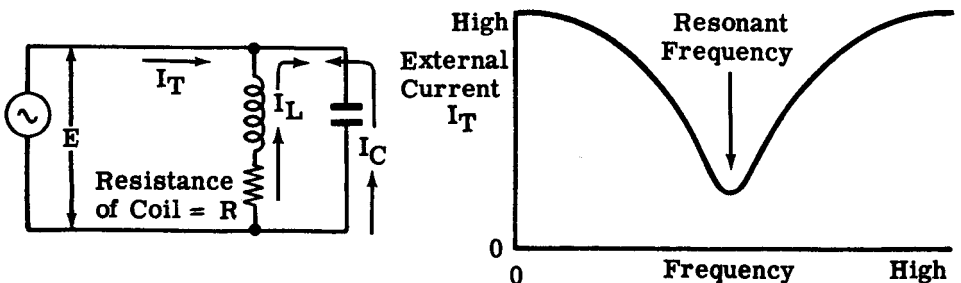

## TUNED CIRCUITS

### How the Resonant Circuit Selects Stations

So far you know that a parallel tuned circuit has a very high impedance at the resonant frequency and a low impedance at all other frequencies. If you understand this, it will be easy to see how a parallel LC circuit selects stations.

#### PARALLEL TUNED CIRCUIT—HIGH IMPEDANCE ONLY AT RESONANT FREQUENCY

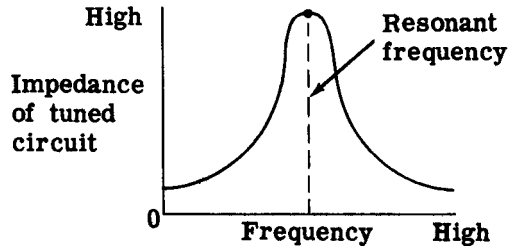

In the circuit shown below, signals of different frequencies strike the antenna. Each of them starts a current flowing in the primary of the antenna coil. Each of these currents in the primary induces a voltage in the secondary. A variable capacitor is in parallel with the secondary of the antenna coil. A parallel LC circuit has a low impedance to all frequencies except its resonant frequency. Therefore it short-circuits signals at all frequencies other than its resonant frequency. It has a high impedance at its resonant frequency. Therefore it does not short-circuit the signal at this frequency, but allows it to build up.

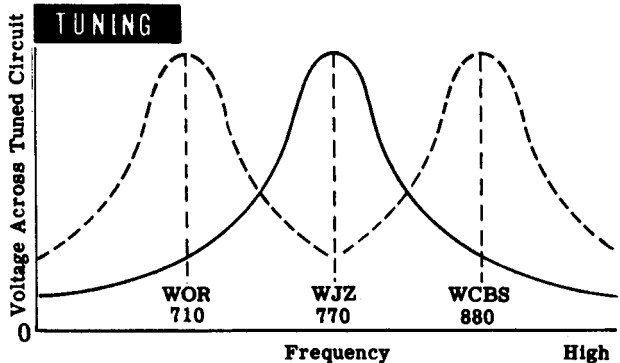
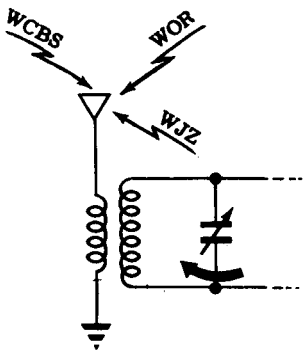

#### Changing Capacitor Setting—Changes Circuit's Resonant Frequency

One particular coil and one particular capacitor will resonate to one frequency only. Varying either the inductance or the capacitance of the tuned circuit will change the resonant frequency. In the process of tuning, you can change the capacitance of the tuned circuit by using a variable capacitor. When the resonant frequency of the LC circuit coincides with the frequency of some signal, you have tuned the RF amplifier to that signal.

Naturally no tuning system is perfect. Signals whose frequencies are very close to each other will all get to the loudspeaker. Then the one to which the receiver tunes will be only a little louder than the others. Signals of exactly the same frequency will certainly get to the loudspeaker together. Then, the strongest signal will be heard the loudest.

# TUNED CIRCUITS

## "Q" and Selectivity

In audio and video amplifiers, it is desirable to have the amplification stage pass a wide range of frequencies. On the other hand, in RF amplifiers we would like the amplification stage to select a narrow band of frequencies and reject the rest. Only then can it separate stations which are close together on the dial. The narrower a band of frequencies passed by an amplifier, the greater is its selectivity. Thus selectivity is the ability of an amplifier to select one of many signals which are close in frequency.

### POOR SELECTIVITY

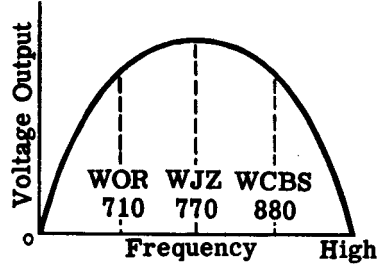

### GOOD SELECTIVITY

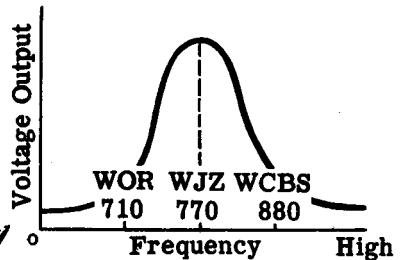

The selectivity of an RF amplifier is determined by its tuned circuits. The lower we can make a coil's resistance in proportion to its reactance, the more selective it will be. The measure of a coil's selectivity is "Q," which is equal to its reactance divided by its resistance. Since the resistance of a capacitor is lower than that of a coil, the coil is the weakest link in a tuned circuit. The Q of the tuned circuit is the Q of the coil.

$$Q = \frac{\text{REACTANCE OF COIL} - X_L}{\text{RESISTANCE OF COIL} - R_L}$$

High Q → Sharp tuning → Good separation of stations

Low Q → Broad tuning → Poor separation of stations

## TUNED CIRCUITS

### How Tuning Capacitors Are Constructed

In Basic Electricity you were shown the construction of the two types of capacitors, fixed and variable. Variable capacitors are used in tuned circuits so that you can vary their capacitance and thus change the frequency. Variable capacitors have one set of plates called the rotors which can be rotated in and out of another set of fixed plates called the stators. The dielectric is air. As the rotor plates are rotated farther and farther out of the stators, the capacity of the unit decreases.

Most radio receivers with RF amplifiers employ more than one tuned circuit. Each tuned circuit needs a variable capacitor. If you mounted each variable capacitor separately, you would have to tune each one separately and this would be inconvenient. Instead, you can mount the rotors of several identical variable capacitors on a single shaft. This is called "ganging" them. When one rotor is turned, the others turn the same amount.

ONE-GANG CAPACITOR

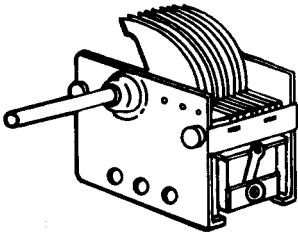

TWO-GANG CAPACITOR

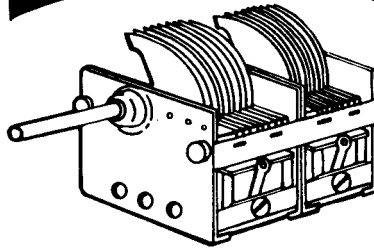

Ganged capacitors involve one big difficulty. Although each of the ganged units measures the same size and has the same spacing, there are small differences in capacity between the units. This is because it is economically impractical to manufacture any two things which are exactly the same size. To compensate for the differences in capacity, a small variable capacitor is connected in parallel with each variable capacitor unit to be ganged. Each of these small compensating capacitors can be adjusted separately until all of the gangs have the same capacity. These compensating capacitors are called "trimmers" because their capacitance is used to trim the capacitance of the main tuning units.

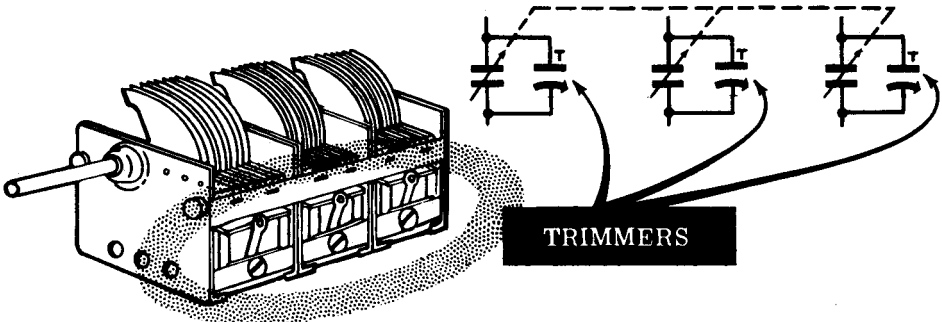

How Tuning Coils Are Constructed

Many tuned RF coils are really transformers and have two windings—the primary and secondary. The coils are wound on a bakelite or cardboard form and generally have an air core, although low frequency coils may occasionally have a powdered iron core.

In order to prevent stray electric fields from affecting the action of RF coils, shields are generally placed around the coils. These shields alter the the inductance of the coil. Therefore any receiver adjustments, such as the alignment process which will be described shortly, should be performed with the shields in place.

# Construction of TUNING COILS

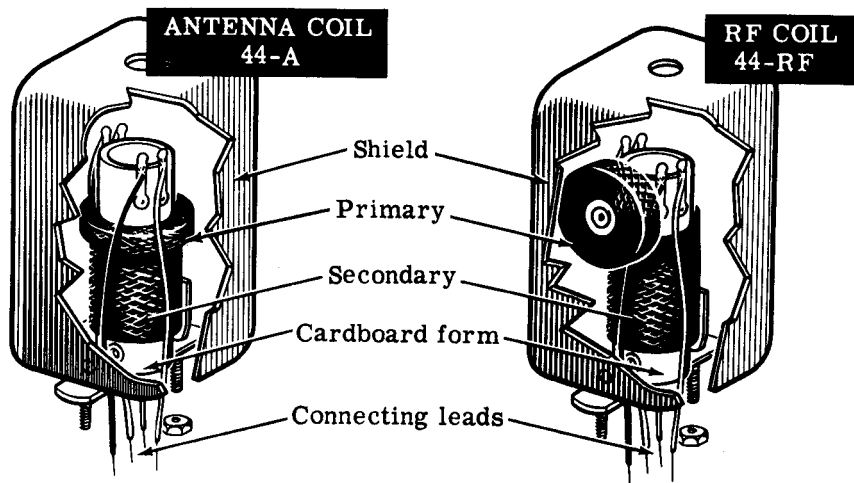



# TUNED CIRCUITS

## Review of Tuned Circuits

In this topic you have studied the action of a resonant circuit and how resonant circuits are used to tune RF amplifiers and radio receivers in general. There are several main points you should understand thoroughly in order to apply what you have learned.

**TUNING**—Selecting a signal at one frequency and rejecting signals at all other frequencies. This is done by a coil and capacitor.

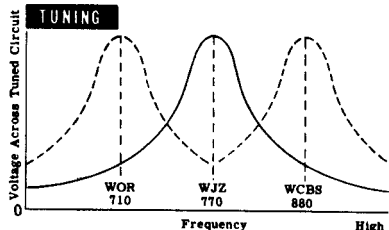

**RF COILS**—Generally have primary and secondary windings. The secondary is usually tuned. Most of them come with shield cans.

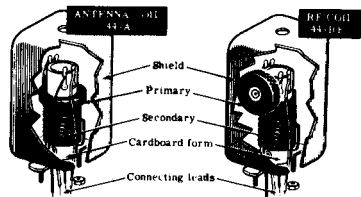

**TUNING CAPACITORS**—These are variable air capacitors. Several air capacitors may be ganged into one unit.

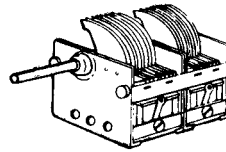

**TRIMMERS**—Are small capacitors placed in parallel with each unit of a ganged capacitor. Their function is to compensate for small differences in capacity between the units.

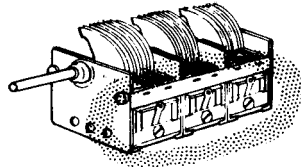

**RESONANT CIRCUIT**—A circuit in which a capacitor and a coil are connected in series or in parallel. Its function is to tune.

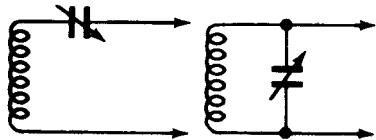

**PARALLEL RESONANT CIRCUIT**—The tuning capacitor is connected in parallel with the coil. It has high impedance at the resonant frequency and low impedance at all other frequencies. It builds up a high voltage at the resonant frequency and a low voltage at all other frequencies. This type of circuit is used most often to tune radio receivers.

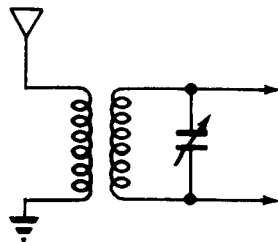

## A SINGLE-STAGE RF AMPLIFIER

### Why the Pentode is Used in RF Amplifiers

You have just studied the operation of the tuned circuits in an RF amplifier. Now you are ready to begin work on the amplifier tube itself. The first question is—what kind of amplifier tube will do the job best?

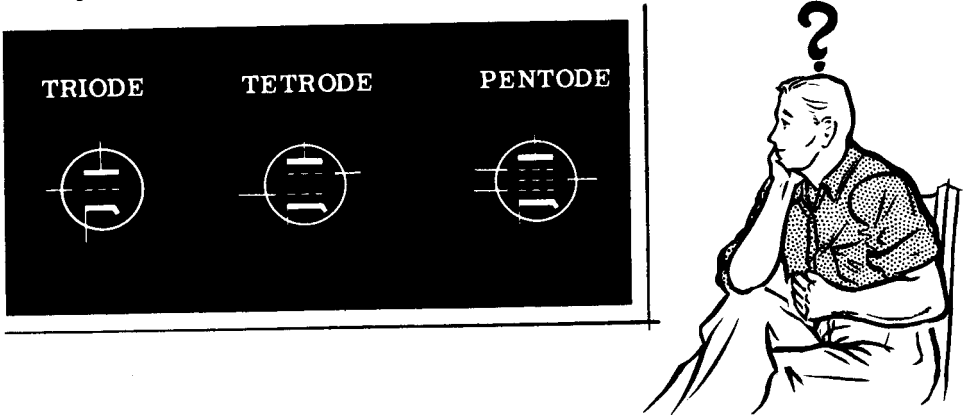

There are three types of tubes which might be used—the triode, the tetrode and the pentode. At first glance it might seem that the triode is the best tube to use since it is the simplest of the three. However, the triode has two great disadvantages when used as an RF amplifier—no triode has an amplification factor of over 100. Tetrodes and pentodes have much higher amplification factors and therefore are capable of amplifying many more times.

Triodes have a much higher capacitance from grid to plate than tetrodes or pentodes. An RF amplifier generally has tuned circuits in both its input and its output and these tuned circuits resonate to the same frequency. When you learn about oscillators you will find out that a triode whose output and input circuits are tuned to the same frequency tends to generate its own signal, or oscillate because of the high grid to plate capacitance. At this point all you need to know is that a triode used as an RF amplifier will tend to make the entire receiver howl.

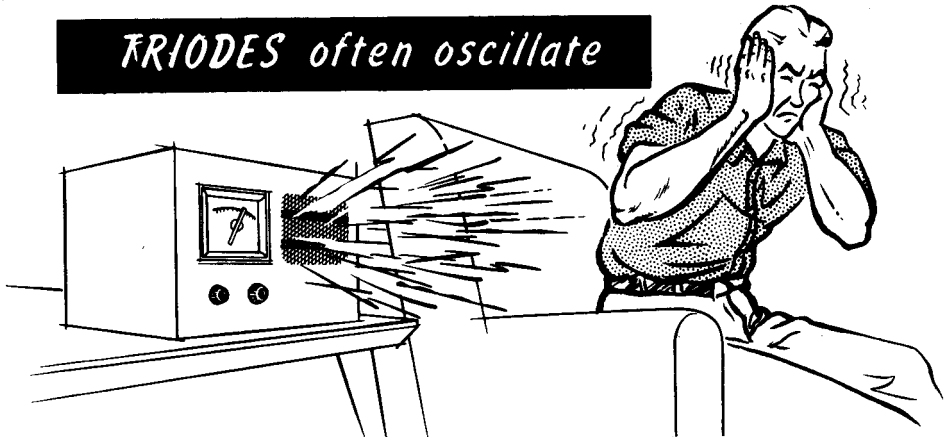

## A SINGLE-STAGE RF AMPLIFIER

### Why the Pentode is Used in RF Amplifiers (continued)

By now it ought to be obvious that a triode is not well suited for use as an RF amplifier. A tube with a screen grid should clear up the difficulties which are encountered when a triode is used. This leaves a choice between the tetrode and the pentode.

Tetrodes do not oscillate because the screen grid cuts down the capacity between the control grid and the plate. They do have two drawbacks, however, that are not present in the pentode. Tetrodes do not have an amplification factor of over several hundred, while pentodes have an amplification factor up to several thousand. Therefore pentodes are preferable. Also, the tetrode produces secondary emission. Electrons from the cathode hit the plate at high velocities. Some of them bounce off of the plate and are attracted to the screen grid which is at a positive potential. This cuts down the plate current and causes distortion. Secondary emission is not present in the triode because it has no screen grid. Pentodes do not have this difficulty for a different reason.



Pentodes have a third grid which is placed between the screen grid and the plate. This is the suppressor grid put there for the sole purpose of cutting down secondary emission. This is how it works. Electrons which bounce off the plate might drift back to the screen grid if the suppressor grid were not there to stop them. The suppressor grid is connected to the cathode or to ground and has an excess of electrons just like the cathode. Therefore the electrons which bounce off the plate are repelled back to the plate by the suppressor grid, and secondary emission is virtually eliminated.



## A SINGLE-STAGE RF AMPLIFIER

### How the Coils and Capacitors are Connected to the Tube

You can connect coils and capacitors in two possible ways to make them tune to a given frequency—in series or in parallel. Almost all RF amplifiers employ parallel tuned circuits. The most common method of arranging tuned circuits in an RF amplifier, and the one you will use, is shown below.

#### USUAL COUPLING METHOD— RF AMPLIFIER

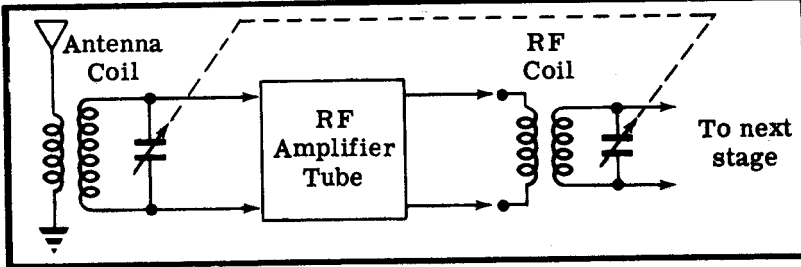

However, this is not the only type of circuit which can be used to tune an RF amplifier. You may occasionally find other circuit arrangements. Either the input circuit or the output circuit may be altered and still produce a practical tuning arrangement. Here are some other ways.

#### DIFFERENT WAYS OF CONNECTING THE INPUT

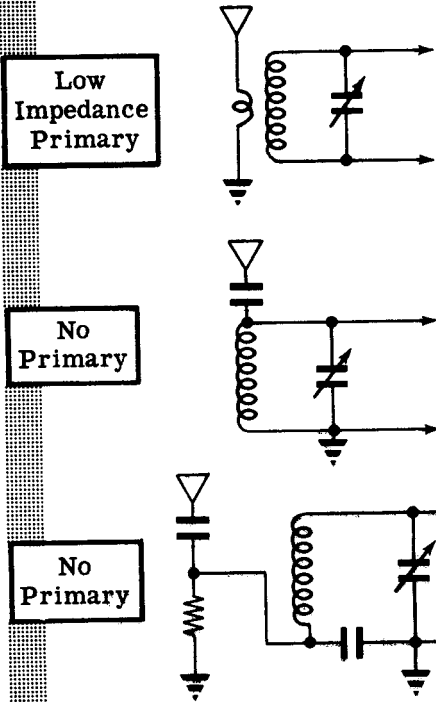

#### DIFFERENT WAYS OF CONNECTING THE OUTPUT

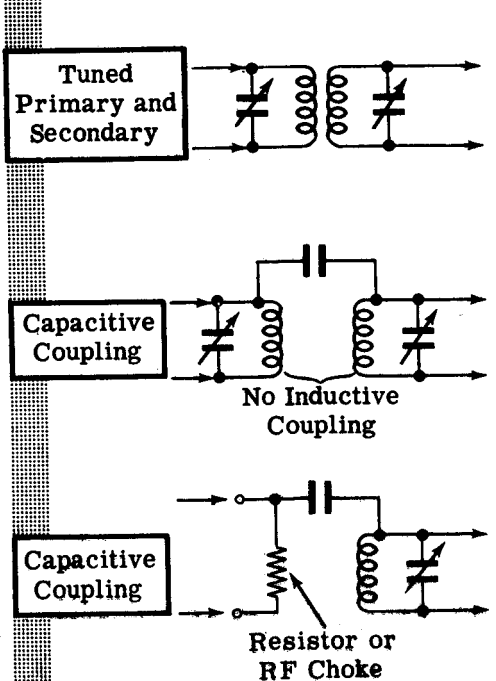

# A SINGLE-STAGE RF AMPLIFIER

## The Development of the RF Amplifier Circuit

You remember from the sections on vacuum tube theory that the function of a grid is to permit amplification of a signal. The signal to be amplified is fed into the grid and the output of the tube is taken from a load impedance in the plate circuit. You know how pentodes operate, and you know how tuned circuits operate. Now put them together, and this is what you have.

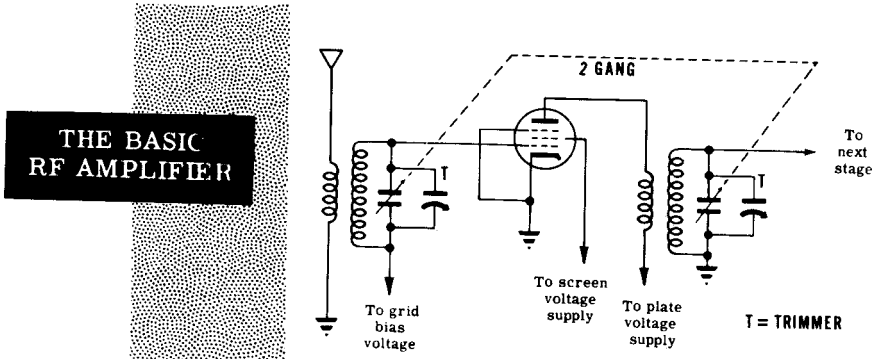

There are only a few differences between the above circuit and circuits actually used in radio receivers. First of all, separate power supplies are seldom used for the plate and screen voltages. The plate voltage supply is generally lowered by a dropping resistor or a voltage divider to supply voltage to the screen (see R-2 in diagram below). Also the voltage on the screen should not be allowed to vary up and down with changes in the signal, or distortion will result. For this reason the screen needs its own bypass capacitor (C-6).

Secondly, grid bias voltage is seldom taken from an outside source. Instead it is generated by the tube itself, using a method which should be familiar to you—cathode bias (R-1). The cathode bias resistor is bypassed to prevent degeneration (C-5).

Very often in multi-stage RF amplifiers a decoupling filter (C-7 and R-3) is placed in the plate supply to prevent one stage from interacting with the next. It is a good policy to use a decoupling filter even in a single-stage RF amplifier.

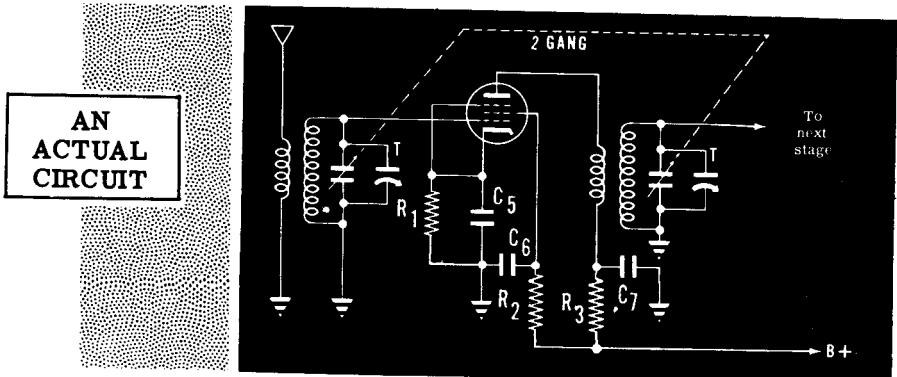

# A SINGLE-STAGE RF AMPLIFIER

## The Remote Cut-off Pentode

If you look up the 6SK7 in the tube manual, you'll find it is called a "remote cut-off" pentode. In other places it is called a "variable mu" pentode and a "super control" tube. The first two titles actually describe an important feature of this tube. The third title describes nothing and is just a name.

In order to understand the remote cut-off feature, suppose you examine the ordinary pentode. This will serve as a basis for comparison. The ordinary pentode, such as the 6SJ7, is called a "sharp cut-off" tube. With 250 volts on the plate and 100 volts on the screen, minus 9 volts on the grid cuts off the 6SJ7. Under the same conditions, minus 35 volts are needed to cut off the 6SK7. This is why it is called a "remote cut-off" tube.

Varying the bias of a sharp cut-off pentode has very little effect on the amplification of the tube except near the cut-off point. This is because the  $E_g - I_p$  curve is a straight line except near the cut-off point.

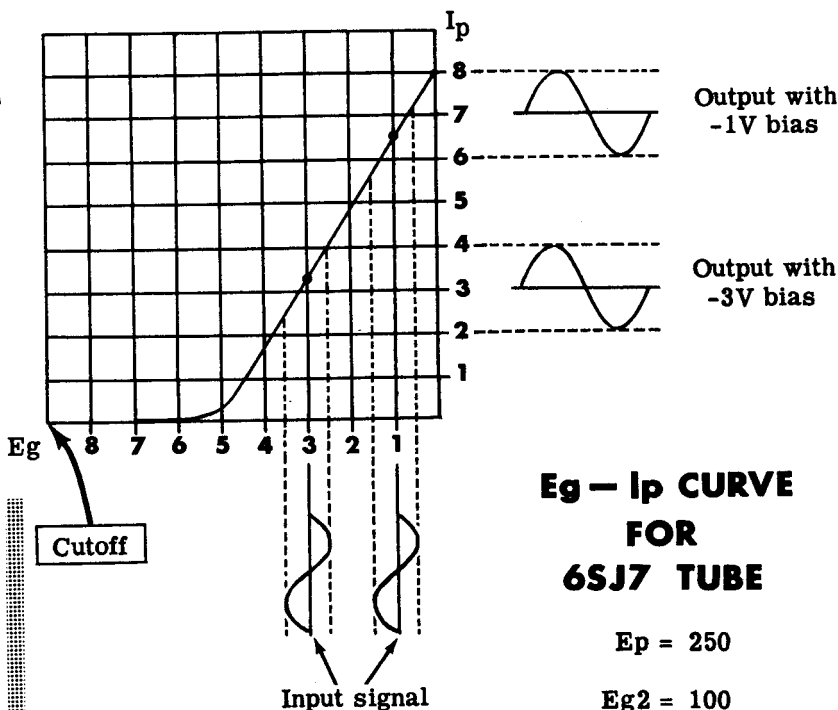

## A SINGLE-STAGE RF AMPLIFIER

### The Remote Cut-off Pentode (continued)

Varying the bias of a remote cut-off pentode varies the amplification. To understand this, look at the  $E_g$ - $I_p$  graph of the 6SK7. The graph shows a 1-volt signal applied to the grid of a 6SK7 under two different conditions: (1) when the bias is -1 volt and (2) when the bias is -9 volts. Notice that the plate current variation is five times as large in the first case as it is in the second case. Therefore the amplification varies with the bias. This is why the 6SK7 is called a "variable mu pentode".

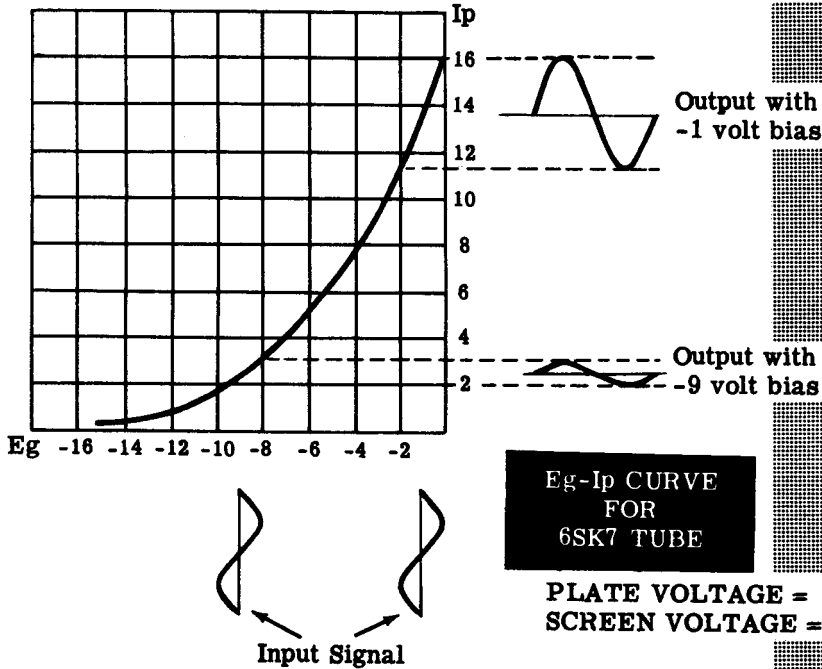

In a remote cut-off pentode the turns of the control grid are spaced closely at the edges and farther apart at the center. The electron flow through the edges of the grid is cut off by very little negative bias. However the electron flow through the center of the grid can only be cut off by a high negative bias. The grid of a sharp cut-off pentode is uniformly spaced. The entire plate current is cut off by one value of bias.

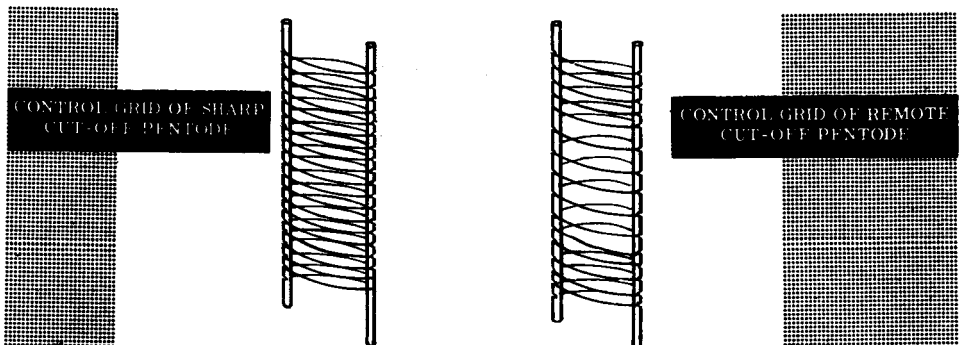

# A SINGLE-STAGE RF AMPLIFIER

## Review of the Single-Stage RF Amplifier

**PENTODE**—A tube used almost universally as an RF amplifier, because it has the highest gain, least tendency to oscillate, and least distortion.

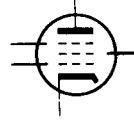

**REMOTE CUT-OFF PENTODE**—A pentode whose  $E_g$ - $I_p$  graph curves continuously. For this reason the gain of a remote cut-off pentode varies with the bias on the grid. Also called "variable  $\mu$ " pentode and "super control" tube.

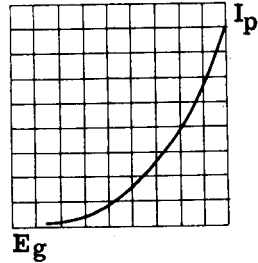

**RF COIL**—The primary is connected between the plate of the RF amplifier and  $B+$ . The secondary is connected between the grid of the next stage and ground. Also shielded most of the time.

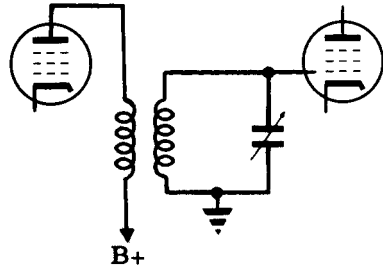

**GAIN**—The number of times a tube or RF coil amplifies a signal. The gain of an RF amplifier can be varied with a pot. placed between the cathode and ground (if a remote cut-off pentode is used).



**SELECTIVITY**—Is the ability of an RF amplifier to separate signals whose frequencies are close together. The narrower a band of frequencies passed by an RF amplifier, the more selective it is.

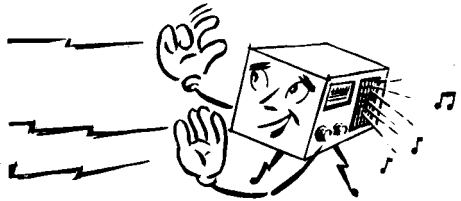

**SELECTIVITY CURVE**—This is a graph of the frequency response of an RF amplifier. It shows you the gain of the RF amplifier over the frequencies which it is designed to cover.

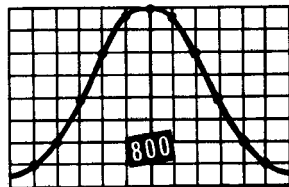



## THE TWO-STAGE RF AMPLIFIER

### Why More Than One RF Stage Is Used

You remember from the previous topic that an RF amplifier performs two functions:

1. It amplifies an RF signal.
2. It selects a frequency.

When a receiver is close to a transmitter, the signal picked up by the receiver is strong. Such receivers probably need only one RF amplifier stage. On the other hand, some receivers are designed to pick up signals from transmitters several thousand miles away and by the time this signal reaches the receiver, it is very weak; the receiver needs extra amplification to boost it. Such receivers require more than one RF amplifier stage.

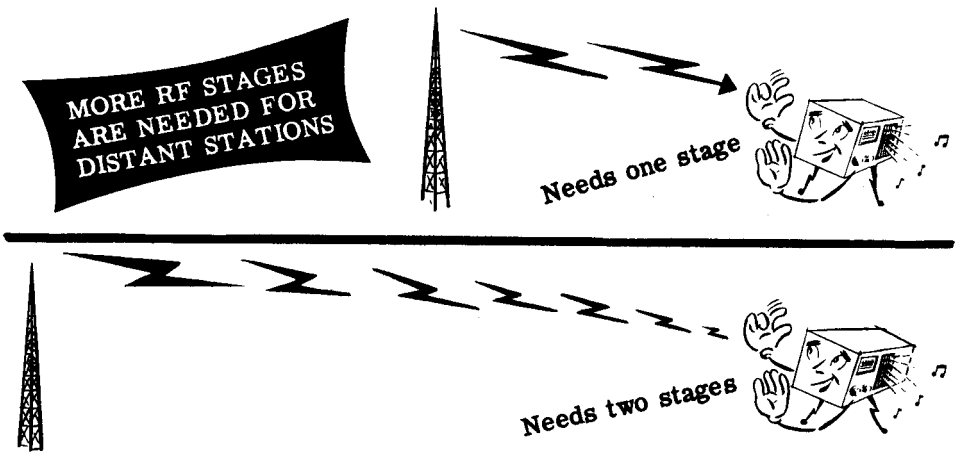

There is a second, and less obvious, reason for using more than one RF stage. More than one RF amplifier stage gives greater selectivity. More selectivity permits a receiver to separate stations whose frequencies are very close together. There are radio frequency bands in which many stations are crowded into a few megacycles. Receivers designed to cover these bands need more selectivity than one tuned RF amplifier can give them.



MORE RF STAGES ARE NEEDED WHERE SIGNAL FREQUENCIES ARE CLOSE TOGETHER

## THE TWO-STAGE RF AMPLIFIER

### Why More Than One RF Stage Is Used (continued)

In order to understand how more RF stages give better selectivity, suppose you examine a typical selectivity curve more carefully. Figure 1 is a curve for a single stage RF amplifier tuned to 500 kc. 10 microvolts of RF are fed into the amplifier.

You will notice that the output of the amplifier at 500 kc is 100 microvolts.

Therefore the gain at 500 kc is:  $\frac{\text{OUTPUT}}{\text{INPUT}} = \frac{100}{10} = 10$ .

The output at 465 kc and 535 kc is 50 microvolts.

Therefore the gain at these frequencies is  $\frac{50}{10} = 5$ .

The single-stage amplifier amplifies the resonant frequency twice as much as frequencies 35 kc away:

$$\frac{\text{GAIN at 500 kc}}{\text{GAIN at 465 kc or 535 kc}} = \frac{10}{5} = 2.$$

Suppose you took another RF stage, identical with the first one, and hooked it up to amplify the output of the first stage. Figure 2 shows the overall selectivity curve for both stages.

Each stage has a gain of ten at 500 kc. Therefore the gain of both stages is:  $10 \times 10$  or 100 at this frequency. Each stage amplifies five times at 465 kc and 535 kc. Therefore the gain at these frequencies is:  $5 \times 5$  or 25.

You see that the two-stage RF amplifier amplifies the resonant frequency four times as much as it amplifies frequencies 35 kc away  $\frac{100}{25} = 4$ . This

is a much greater selectivity than one tuned RF amplifier will give. Adding a third tuned RF stage will give still more selectivity than two tuned RF stages. It may not always be desirable to have that much selectivity. Naturally, untuned RF stages have no effect on the selectivity.

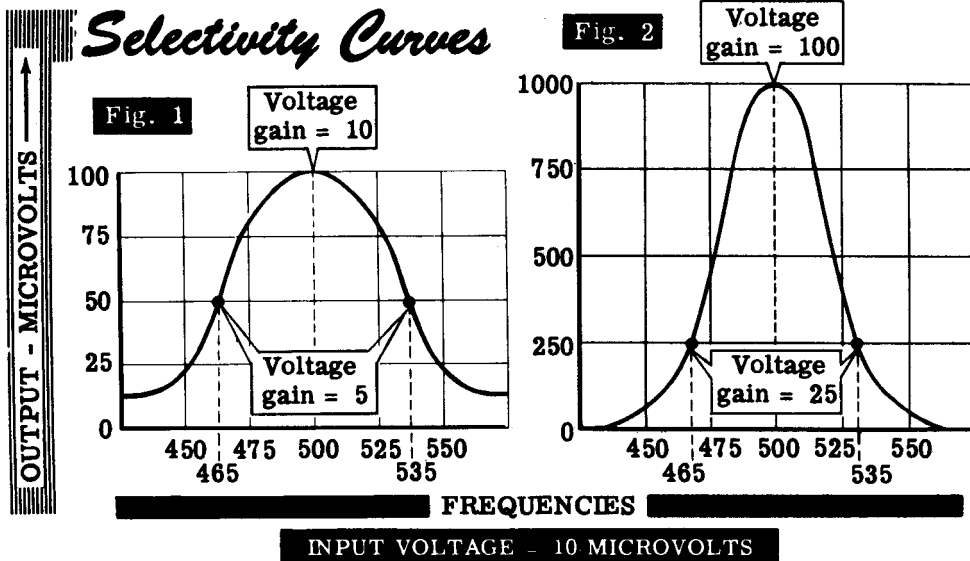

## THE TWO-STAGE RF AMPLIFIER

### Selectivity and Bandpass

There is another idea, related to selectivity, which you ought to understand. This is the idea of "bandpass." The word itself gives you some hint of what it means. It refers to the width of the frequency band passed by an amplifier. Most of the time it is used in connection with RF amplifiers.

**BANDPASS** - The width of the band of frequencies which is passed by an amplifier between the two points on the selectivity curve where the output is seven-tenths of the output at the resonant frequency.

This is the exact definition of bandpass, but it's a complicated one. You may get a better understanding if you examine an actual selectivity curve and calculate the bandpass. Here is the selectivity curve of a single stage RF amplifier taken from the previous sheet.

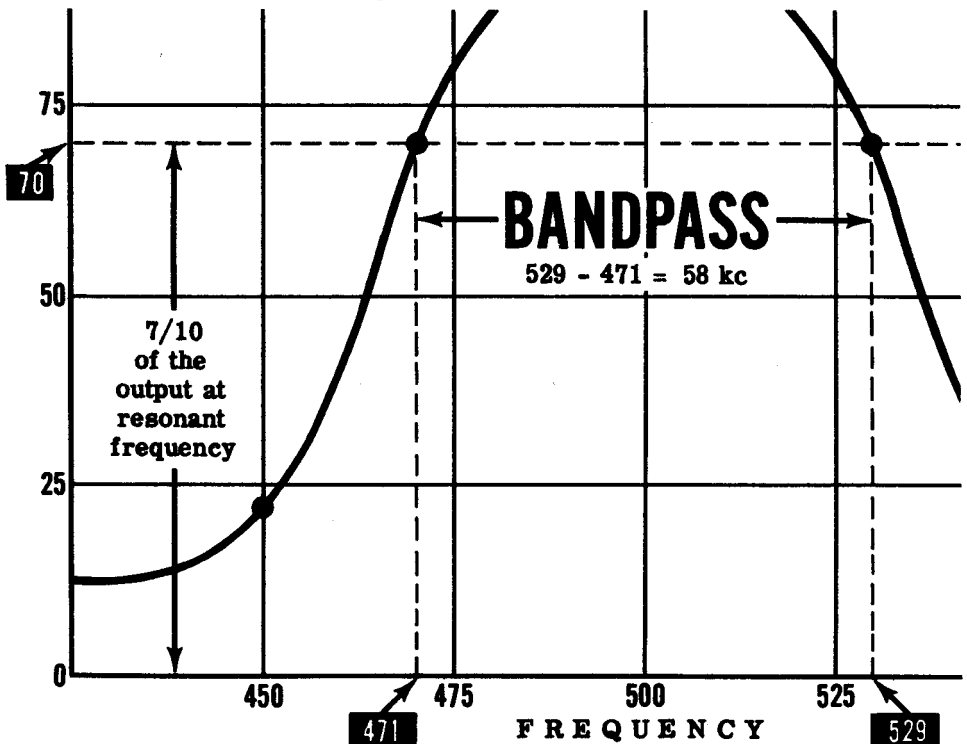

The output of the stage at the resonant frequency is 100 microvolts. Seven-tenths of this is 70 microvolts. The amplifier stage puts out 70 microvolts at 471 kc and at 529 kc. 529 kc minus 471 kc equals 58 kc. The bandpass of this particular RF amplifier is 58 kc. Now read the definition of bandpass again.

The greater the selectivity, the narrower the bandpass. Calculate the bandpass for the two-stage RF amplifier described on the previous sheet.

## THE TWO-STAGE RF AMPLIFIER

### How RF Stages Are Coupled

Although you probably know already how one RF amplifier stage is coupled to the next, it might be good to review it at this point. There are several possible ways of coupling two RF stages. The most commonly used method is shown in the illustration below.

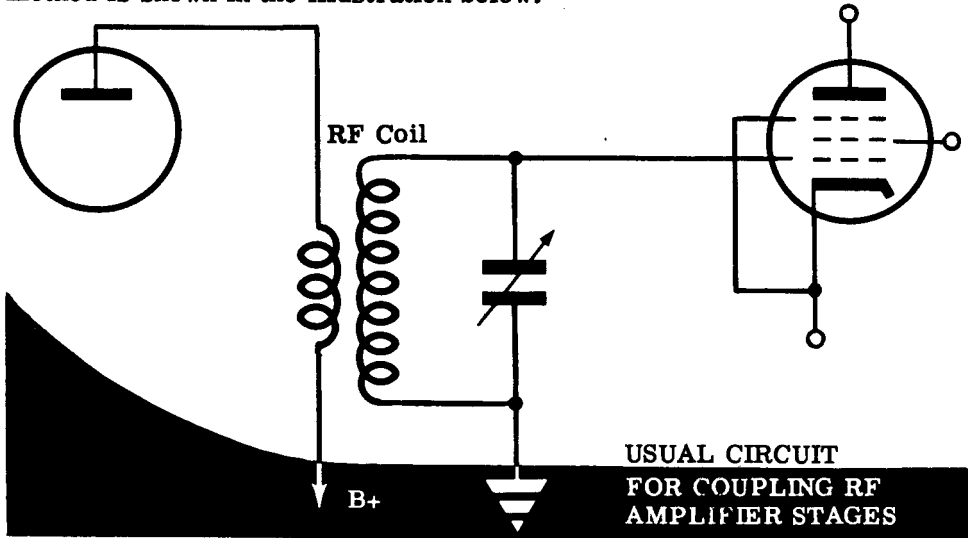

Notice that the plate load for the first stage is a coil. This coil is the primary winding of an RF transformer and has a high impedance at radio frequencies. The RF signal current flowing through the coil induces a voltage in the secondary winding. The secondary winding is tuned with a variable capacitor which is ganged to the capacitor that tunes the first RF stage. The action of this RF transformer is essentially the same as the action of an audio transformer in a transformer-coupled audio amplifier, except that the secondary of the RF transformer is tuned.

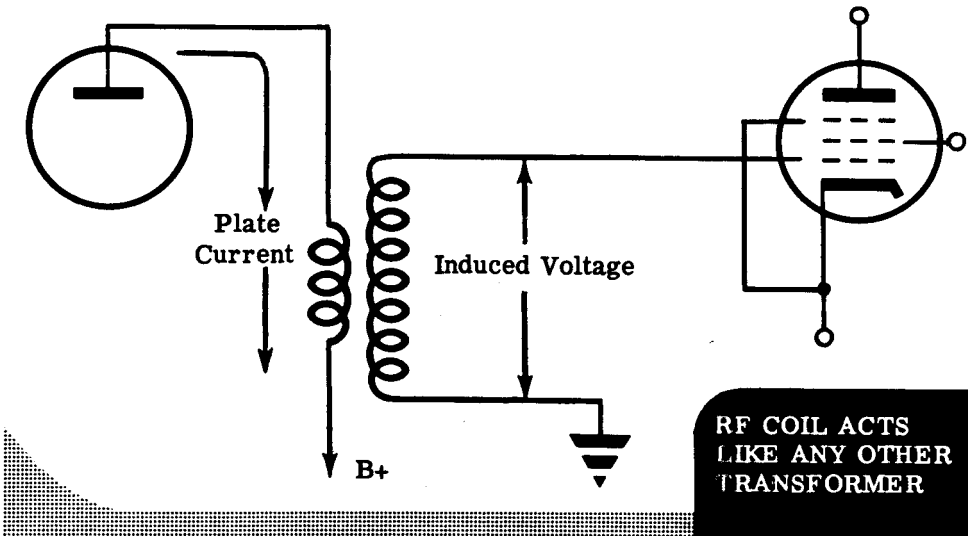

# THE TWO-STAGE RF AMPLIFIER

## Review of the Two-Stage RF Amplifier

**TWO-STAGE RF AMPLIFIER** — When correctly adjusted, it gives more amplification and more selectivity than a single-stage RF amplifier.

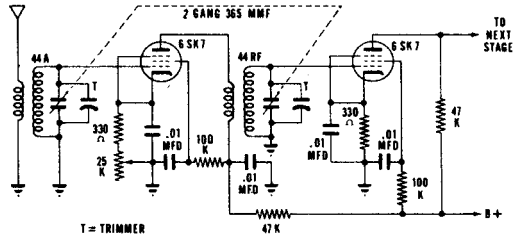

**BANDPASS** — The width of the band passed by an amplifier between the two points where the output is seven-tenths of the output at the resonant frequency. The greater the selectivity, the narrower the bandpass. The greater the bandpass, the poorer the selectivity.

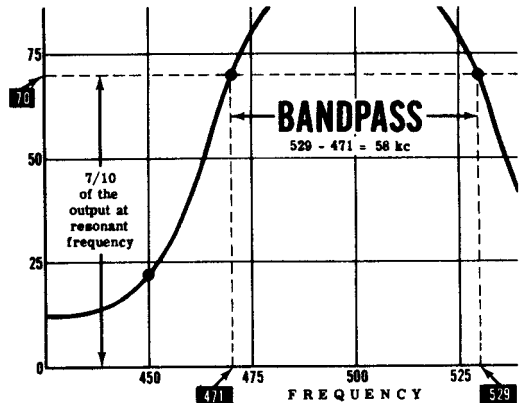

**ALIGNMENT** — The process of adjusting trimmers in a group of tuned amplifier stages so that all the stages tune to the same frequency. When a multiple-stage RF amplifier is correctly aligned, it will give more selectivity than a single-stage amplifier. When it is not correctly aligned, it may give far less selectivity or even tune to two frequencies at once.

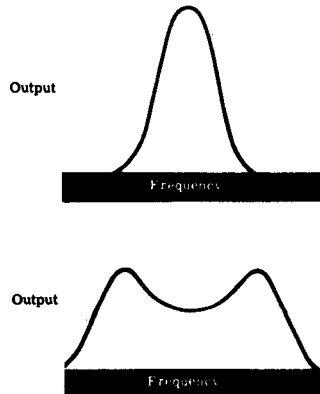



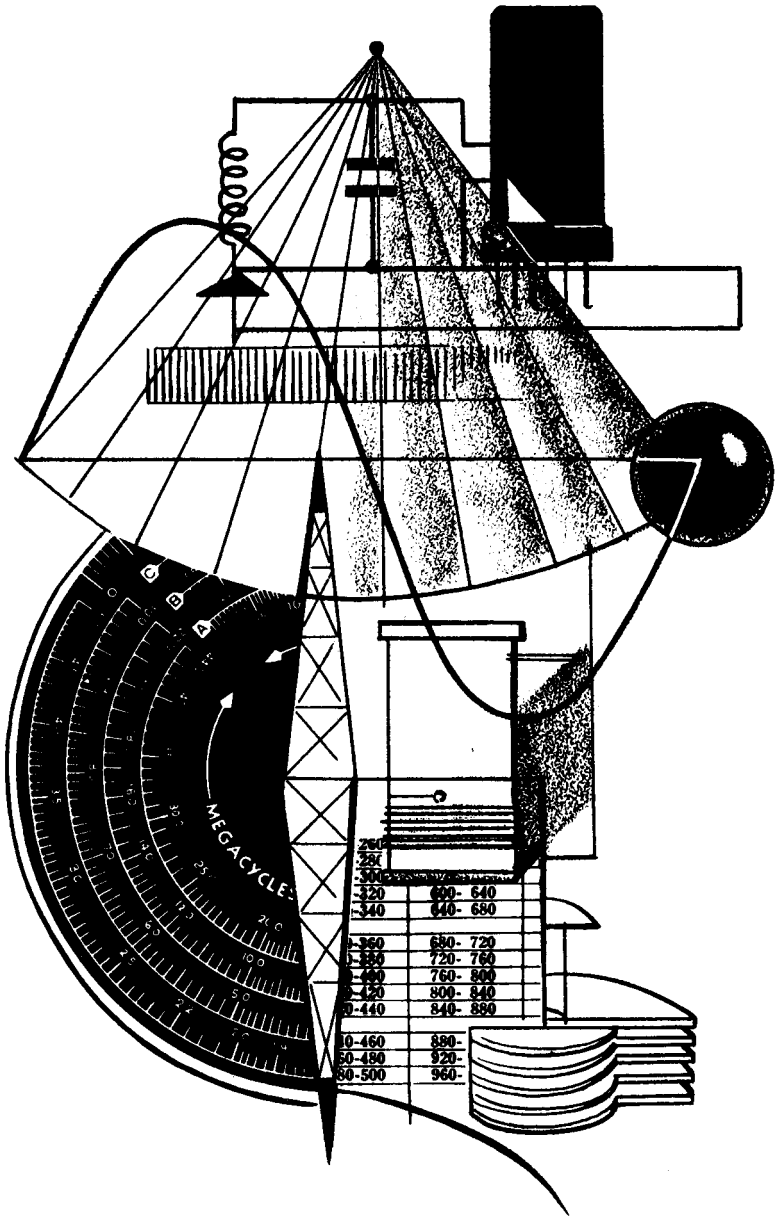

## Oscillators





## INTRODUCTION TO OSCILLATORS

### Why You Study Oscillators

You have studied how amplifiers function in electronic circuits. No less important are oscillator circuits, or, simply, oscillators. Most modern radio receivers which you have used in your home and in your automobile contain oscillators. Every transmitter that sends intelligence through the air employs an oscillator to produce these signals. This is not only true of "ground stations" like WNBC or WCBS; it applies to every transmitter on a ship or plane. Inter-ship and plane-to-ship communications would be greatly limited if oscillator circuits were not employed.

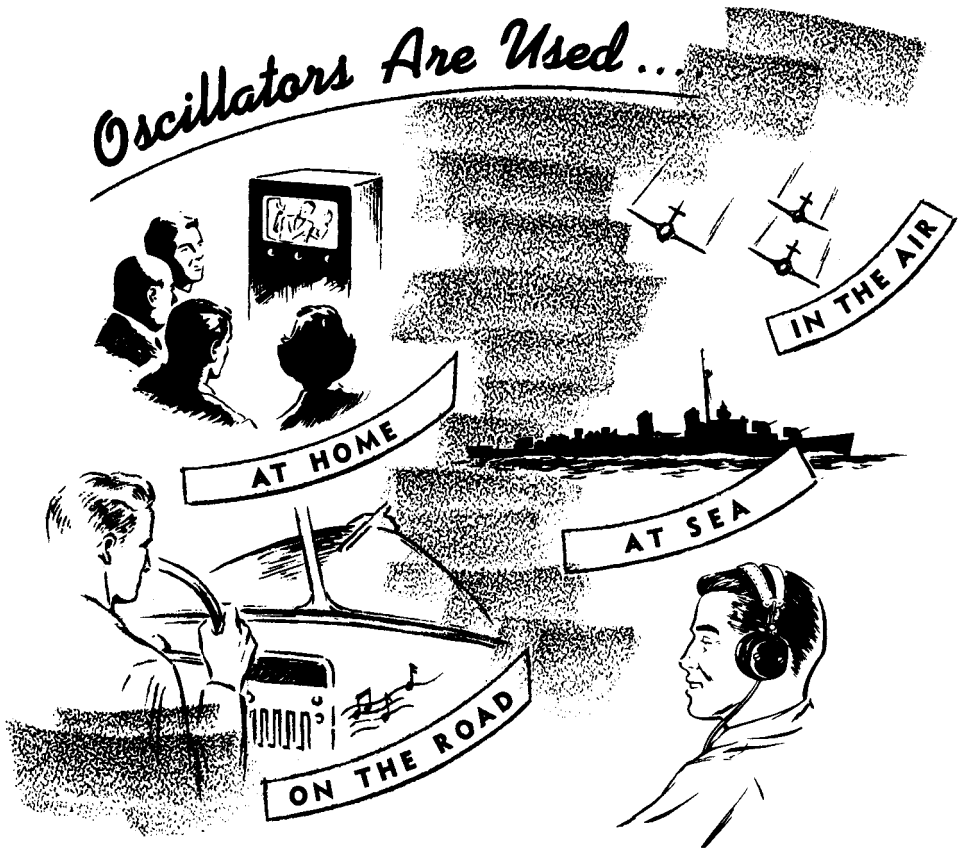

Oscillators are not used exclusively in communications equipment. The test equipment you use—signal generators and frequency meters—contain oscillator circuits. You will find oscillators in radar and sonar equipment, as well as in certain guided missiles and torpedoes.

# INTRODUCTION TO OSCILLATORS

## What an Oscillator Does

Now you probably want to know what an oscillator does that makes it so important.

An oscillator does nothing more than put out an AC voltage at a desired frequency. The audio signal generator used in working with audio amplifiers is an audio oscillator. The audio oscillator shown below puts out an AC voltage at any frequency from 0 to 15,000 cycles per second. The RF signal generator used in working with RF amplifiers is an RF oscillator, and the RF oscillator shown below can put out an AC voltage at any frequency from 215,000 cycles to 22,000,000 cycles. Both these oscillators supply a test signal that enable you to check and troubleshoot amplifiers.

A radio transmitter takes a high frequency AC voltage, amplifies it, and then radiates this amplified signal to distant points by means of a transmitter antenna. Where does this high frequency AC voltage come from? ... From an oscillator. A radio transmitter is nothing more than an oscillator with some high power RF amplifiers to step up the oscillator signal so that it can be radiated long distances by the antenna. (See Volume 4.)

The most advanced type of radio receiver, the superheterodyne receiver, also contains oscillator circuits. (See Volume 5.)

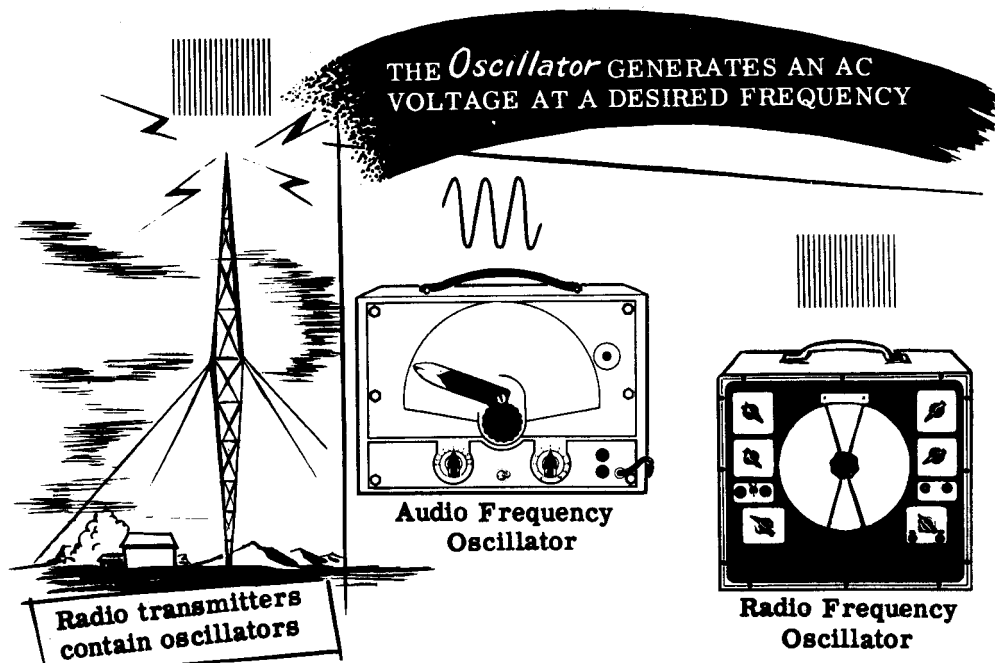

# INTRODUCTION TO OSCILLATORS

## What Oscillations Are

If anything swings back and forth in a uniform way it is said to be "oscillating." A violin string "oscillates" when a bow is drawn over it. A swing moving back and forth "oscillates." A pendulum swinging on a clock "oscillates."

## *Some Common Oscillators*

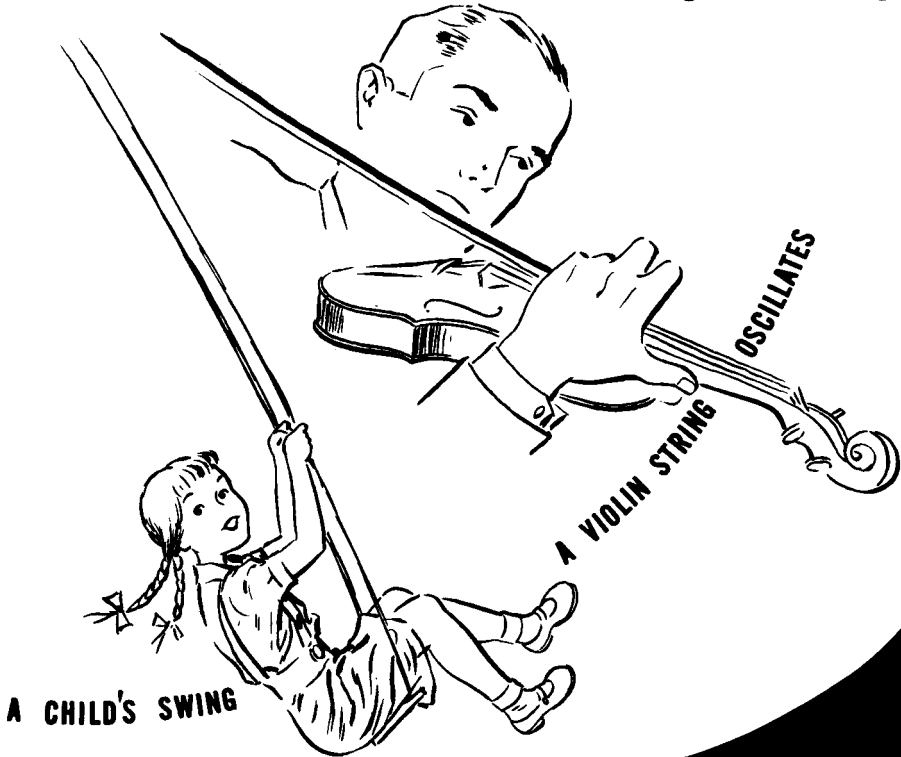

Consider the pendulum. When it reaches the extreme left-hand side of its swing, it comes to rest momentarily, and all its energy is stored as "potential energy." Half way through its swing, it is moving at its greatest speed, and all its energy has been converted to "kinetic energy," or "energy of motion." When it completes one swing, arriving at the extreme right-hand position, it again comes momentarily to rest, and its energy is all "potential" once again. We can represent this motion by one-half a sine wave, plotting velocity against time. Velocity toward the right is considered positive.

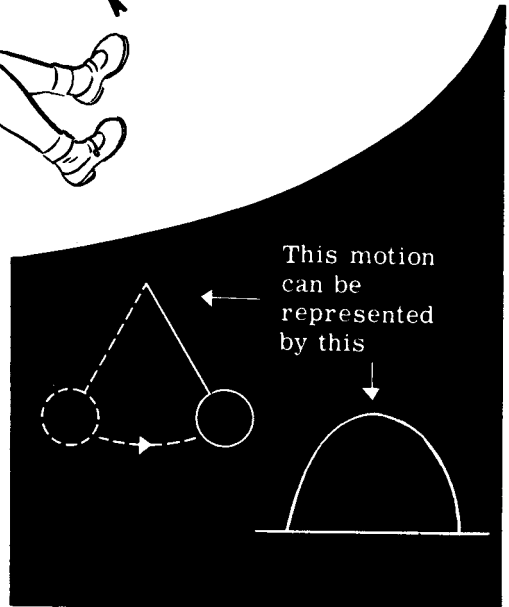

## INTRODUCTION TO OSCILLATORS

### What Oscillations Are (continued)

Since the return swing from right to left is a reversal of direction, the second half of the sine curve is shown below the line. Thus one complete cycle of oscillation of the pendulum may be represented by one complete cycle of the sine wave.

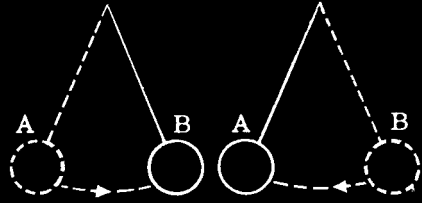

..ONE COMPLETE  
CYCLE OF OSCILLATION

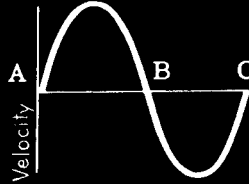

Did you ever notice that one complete trip on the swing takes the same time as any other trip? You can represent three cycles of the swing like this: the time from  $t_1$  to  $t_3$  is the same as that from  $t_3$  to  $t_5$  or that from  $t_5$  to  $t_7$ , as shown below. Also the time required for the various half cycles ( $t_1$  to  $t_2$ ,  $t_2$  to  $t_3$ , etc.) is always the same.

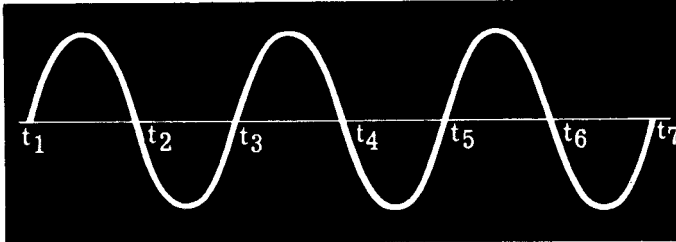

The time between cycles remain constant--

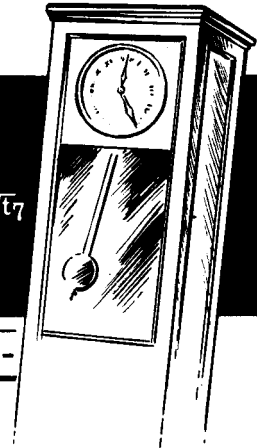

Clocks and watches keep accurate time because the time consumed by any one swing of the pendulum or balance wheel is the same as that for any other swing. This is as true of the seventh swing as it is of the first. Now you understand what was meant by the statement that an oscillator moves back and forth in a uniform way. Two conditions exist when something oscillates: (1) there must be back and forth motion (vibration) and (2) the period of time for each back and forth motion must be the same (uniform).

## INTRODUCTION TO OSCILLATORS

### What Oscillations Are (continued)

You know that the motion of a swing will eventually run down. You know, too, that this loss of energy is due to friction, and to compensate for this loss additional outside energy must be supplied in a uniform way. What happens when outside energy is not supplied can be shown by this curve:

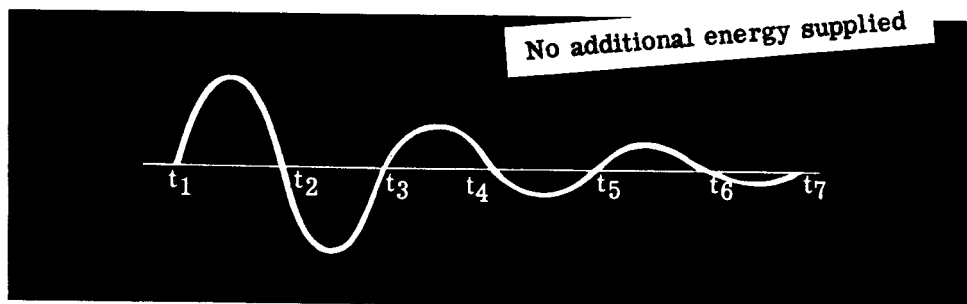

This is called a "damped" wave. It is like a sine wave, but with the height (amplitude) of successive cycles diminishing gradually. The time interval remains the same.

How would you supply the necessary energy to prevent "damping?" If you were pushing a child on a swing you would not make the next push until the swing had just completed its arc, and was about to reverse its direction. This application of energy at the proper point or with the proper timing, is "in phase" with the original motion. To supply energy to an oscillator in order to support its natural period of oscillations, the outside source of energy must be in phase with the natural period of the oscillator.

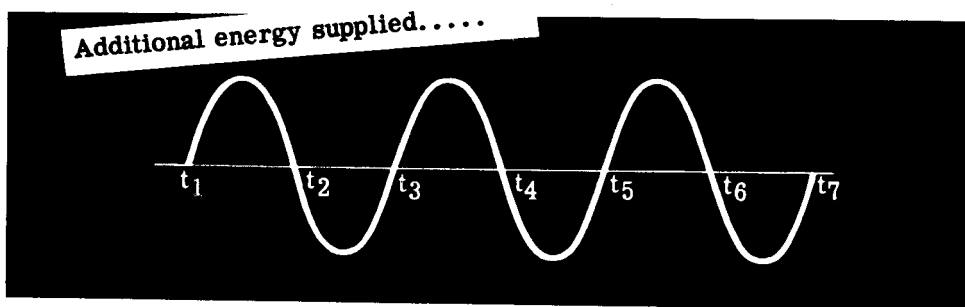

You know now that to support a stable oscillator, two conditions are necessary:

1. Energy must be supplied to compensate for loss of energy in the oscillator.
2. When supplied, the outside source of energy must be in phase with the natural period of the oscillator.

# INTRODUCTION TO OSCILLATORS

## The Electronic Oscillator

An electronic oscillator is a simple circuit—it consists of a capacitor and a coil connected in parallel. To understand how such a circuit can be made to oscillate, suppose you consider what happens when a capacitor is charged and discharged.

An uncharged capacitor has an equal number of positive and negative charges on each plate. When this capacitor is connected across a source of DC voltage, one plate will be charged negatively and the other will be charged positively. What has happened is that there are more than the original number of electrons on the negative plate, and less than the original number of electrons on the positive plate. In addition, the excess of electrons on the negative plate is exactly equal to the loss of electrons on the positive plate.

**UNCHARGED CAPACITOR**

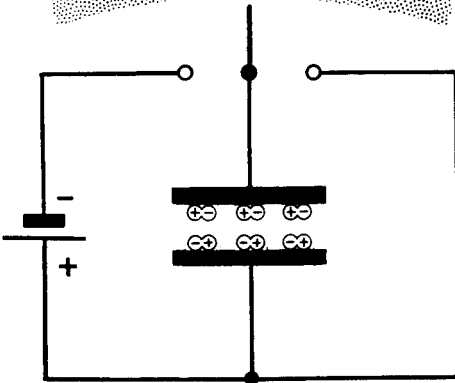

**CHARGED CAPACITOR**

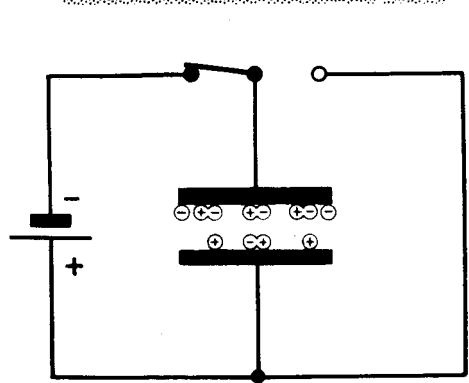

When a short circuit is put across the charged capacitor, the excess electrons are attracted through the shorting wire onto the positive plate. Each plate once more has an equal number of positive and negative charges and the capacitor is uncharged.

**CAPACITOR DISCHARGING**

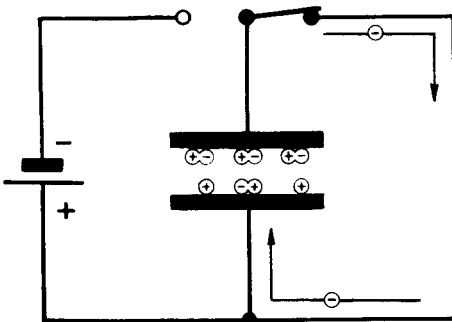

**CAPACITOR DISCHARGED**

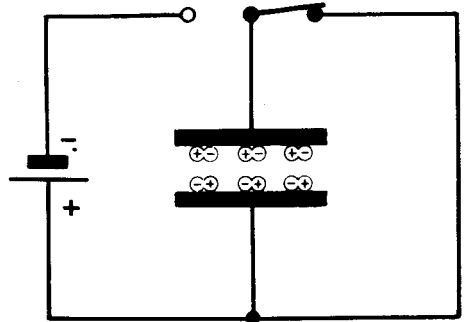

# INTRODUCTION TO OSCILLATORS

## The Electronic Oscillator (continued)

On the previous sheet you saw what would happen if a short circuit were connected across the charged capacitor. If an inductance is connected across the charged capacitor, the results are quite different.

You will remember from your work in Basic Electricity that an inductance has a peculiar electrical characteristic—it resists any change of electron current through itself. You remember that when current flows through a coil, a magnetic field is generated around the coil. Any change in the current causes the magnetic field to expand or contract. This expansion or contraction of the magnetic field causes the magnetic lines to cut across the turns of the coil—resulting in the generation of a voltage which opposes the change in current.

When the charged capacitor is switched across the coil, (1) in the illustration below, the electrons stored on the negative plate and the voltage across the circuit is a maximum. As soon as a small number of electrons flow into the coil, a magnetic field starts to build up. This building up of the magnetic field induces a voltage across the coil which opposes the flow of electrons from the negative plate. The capacitor and coil act like two dry cells connected in series, opposing—positive to positive and negative to negative. As a result, the charged capacitor cannot discharge immediately through the coil. The larger the coil, the longer it takes for the capacitor to discharge. As the capacitor discharges, the magnetic field about the coil becomes stronger and stronger, and the voltage continues to decrease (2).

MAGNETIC FIELD INCREASES  
AS CAPACITOR CHARGE DECREASES

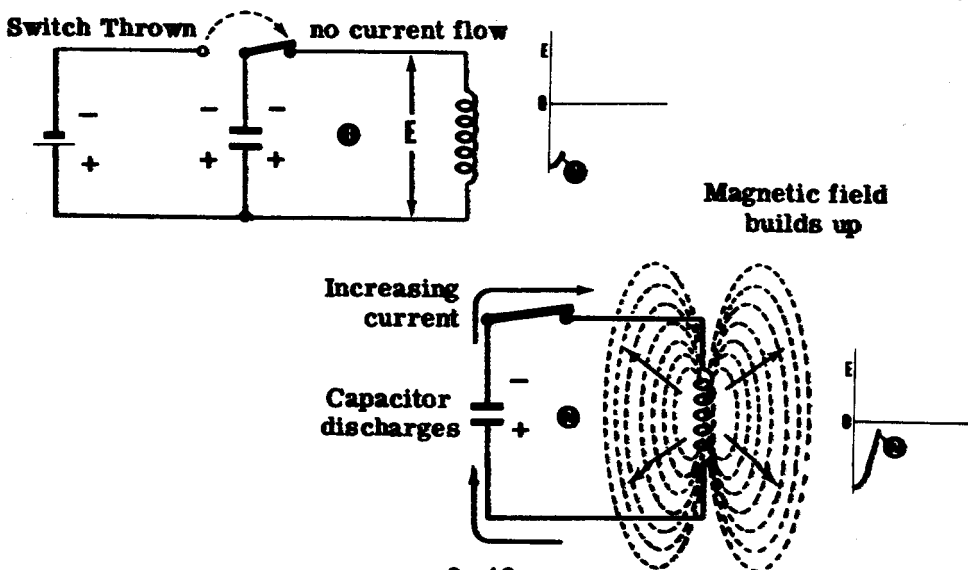

The Electronic Oscillator (continued)

By the time the capacitor has completely discharged, all of its electrical energy has been transformed into magnetic field energy around the coil. As soon as the current through the coil begins to decrease, the magnetic field begins to collapse around the coil (3). The collapsing magnetic lines cut across the turns of the coil and induce a voltage across the coil. This induced voltage prevents the current through the coil from decreasing, and it is opposite in polarity to the original voltage across the capacitor. Now the capacitor and coil act like two dry cells connected in series, aiding—negative to positive. Because of this induced voltage, electrons are forced to flow through the coil in the same direction. Electrons are stripped off the upper plate of the capacitor and forced through the coil onto the lower plate.

All of the energy of the collapsing magnetic field goes into forcing a negative charge on the lower capacitor plate. By the time the field has completely collapsed, all of the magnetic energy has been returned to the capacitor as an electric charge, and the voltage across the capacitor is exactly opposite in polarity to the original charge (4).

WHEN THE CAPACITOR STOPS DISCHARGING,  
**COIL RECHARGES THE CAPACITOR**

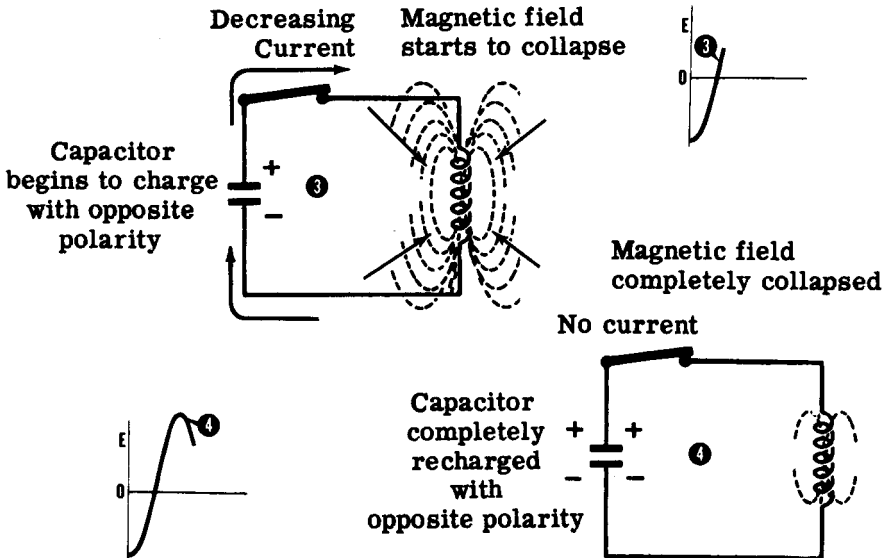



The Electronic Oscillator (continued)

Now that the electrons are all stored on the lower plate of the capacitor, the charge is exactly the opposite to what it was originally. The electrons are now attracted to the upper positive plate through the coil. As the capacitor discharges, a magnetic field builds up around the coil (5). The collapse of this magnetic field forces additional electrons off the lower plate onto the upper plate. By the time the magnetic field has completely collapsed (6), all the electrons are back on the upper plate, and the situation is exactly the same as when the capacitor was first charged. The entire cycle then repeats itself over and over again. Electrical energy is alternately stored as a charge on a capacitor and a magnetic field around a coil. This is what is meant by electronic oscillation.

RECHARGING CAPACITOR TO ORIGINAL CONDITION

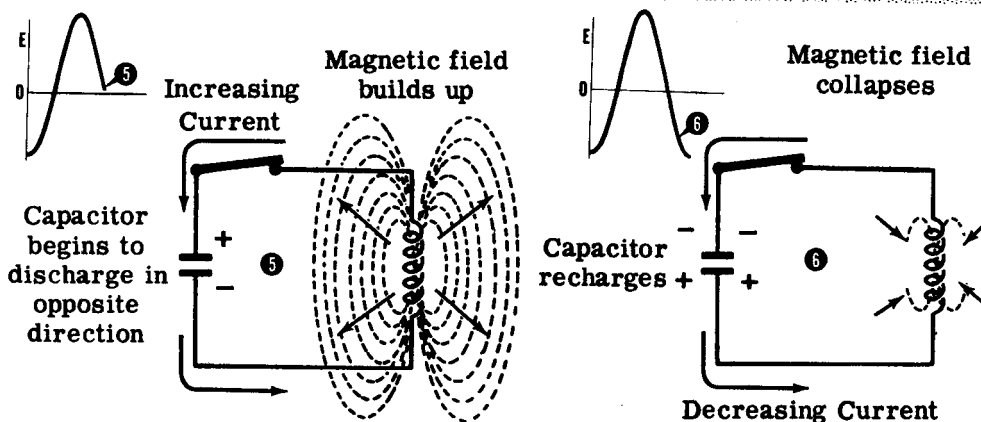

If an oscilloscope were connected in parallel across the coil and capacitor, the rise and fall of voltage would appear as a sine wave if there were no resistance in any part of the circuit. If there were no resistance in the circuit, the oscillations would continue indefinitely. However, resistance cannot be eliminated completely from any circuit, and some of the electrical energy of oscillation is dissipated by the resistance as heat. Due to this loss of electrical energy, the voltage becomes lower and lower on each swing and the oscillation eventually disappears.

Oscillation INDICATED BY THE SINE WAVE

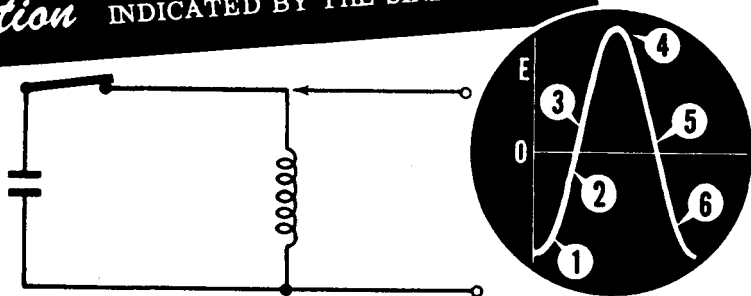

# INTRODUCTION TO OSCILLATORS

## The Electronic Oscillator (continued)

In order to make the oscillations continue indefinitely, enough electrical energy must be put back into the LC circuit (called the "tank circuit") to overcome the losses due to resistance. In addition, this electrical energy must be put back into the circuit at just the right moment so that it will give a little extra "push" or "kick" at the proper time. This electrical kick corresponds to the push given to a swing at the end of its arc.

One way of supplying this electrical push to the LC circuit is to switch a source of voltage across the capacitor just at the moment when the capacitor is reaching its full charge. In this manner, oscillations can be made to continue indefinitely.

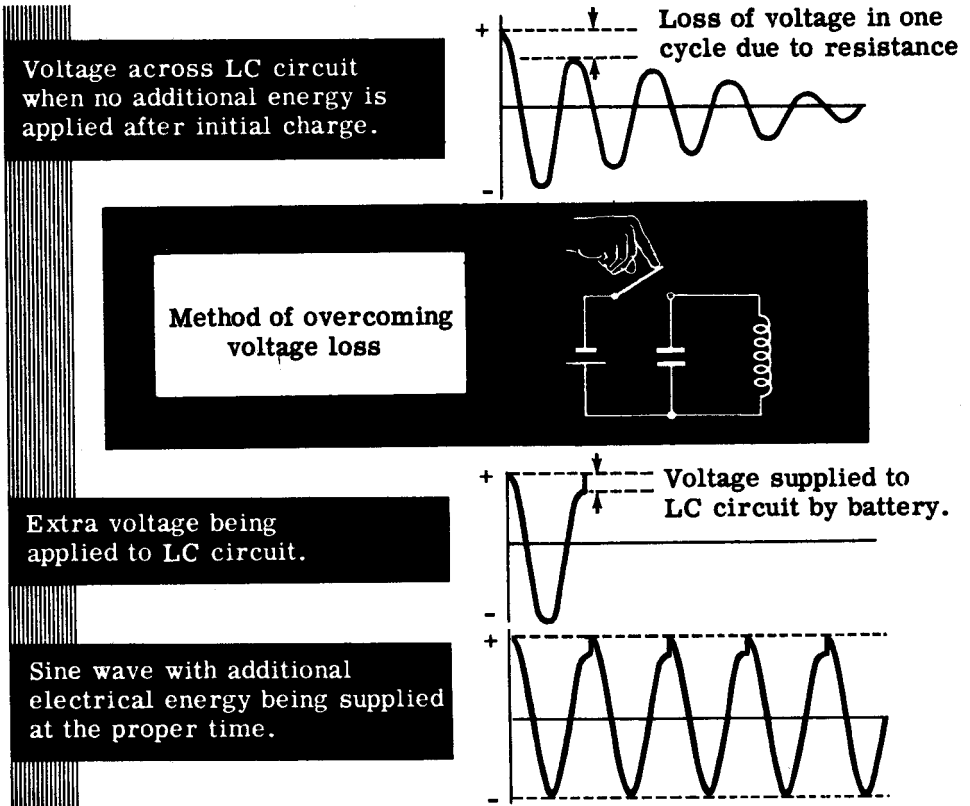

Notice that the only kick the oscillator circuit receives is the small fraction of a volt necessary to overcome the voltage drop due to the resistance in the circuit. The LC circuit is able to generate a sine wave voltage even though the kick it receives does not resemble a sine wave in any manner and even though the kick lasts for only a very small part of the cycle. The flywheel on a one-cylinder engine is able to make one complete turn when it receives only a very brief push from the piston on each revolution. This resemblance between the action of an LC circuit and the flywheel of a one-cylinder engine has led to the use of the term "flywheel effect" to describe the oscillations in an LC circuit.

## The Feedback Circuit

The method of supplying extra energy to the LC circuit described on the previous sheet would work very well if there were some switching arrangement that could work at the frequencies required. Some oscillators must be able to work at frequencies well over 100 million cycles per second, and it is quite obvious that no mechanical switch could work at this speed. The answer to supplying electrical energy at the proper instant is to use a vacuum tube circuit.

By connecting the LC circuit to the grid of a vacuum tube, the oscillating voltage can be amplified. If a small portion of this amplified voltage can be fed back in the proper phase, enough electrical energy will be put back into the LC circuit to overcome the resistance losses in the LC circuit. The vacuum tube used in an oscillator does not do any oscillating—it is the LC circuit that oscillates, and it is the vacuum tube that gives the kick.

THE AMPLIFIER TUBE IS  
USED TO KEEP THE

*LC Circuit Oscillating*

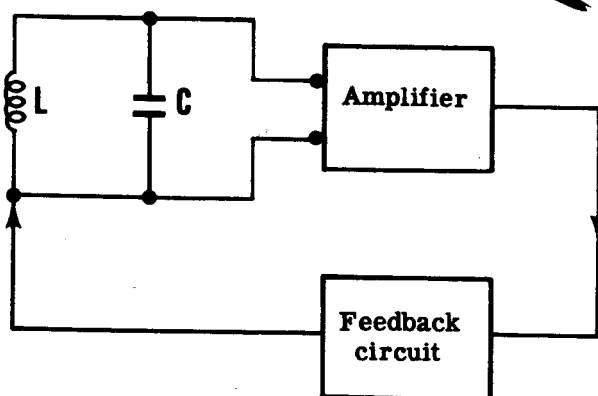

All the oscillators you will learn about in this section operate on the principle illustrated above. The major difference between various oscillators is the method in which a voltage is fed back to the LC circuit in proper phase. You will learn about six basic oscillators: the Armstrong, the Colpitts, the Hartley, the tuned-plate—tuned-grid, the crystal controlled and the electron-coupled oscillators. You will see how these oscillators work, and the advantages and disadvantages of each type.

# INTRODUCTION TO OSCILLATORS

## Frequency Stability of Oscillators

One important characteristic of oscillators, which you are going to learn about, is frequency stability. Although you have not yet studied oscillators, it ought to be obvious that an oscillator should maintain the frequency to which it is set. Unfortunately, all oscillators tend to drift in frequency unless steps are taken to prevent this. Some circuits drift less than others.

Imagine what would happen if frequency drift were not taken into account. If one ship were trying to contact another, and the oscillator in its transmitter drifted off frequency, the message would never be received. If the oscillator in a shipboard receiver drifted off frequency, that ship would receive no messages at all. If the oscillator in a shipboard sonar unit drifted off frequency, that ship could not detect submarines. It would be torpedoed by the first enemy submarine that came along. A great proportion of electronic equipment contains oscillators. If these oscillators were allowed to drift off frequency, all this equipment would be useless until the oscillators were reset to the correct frequency.

Thus you can see that it is necessary to understand frequency stability and drift. Drift is caused by several factors. Vibration, varying loads and varying supply voltages will cause an oscillator to drift. Changes in temperature will, also. Since much electronic equipment is subject to all of these factors, some compensation is usually included in all equipment which contains an oscillator. You will learn about these things in the next few topics.

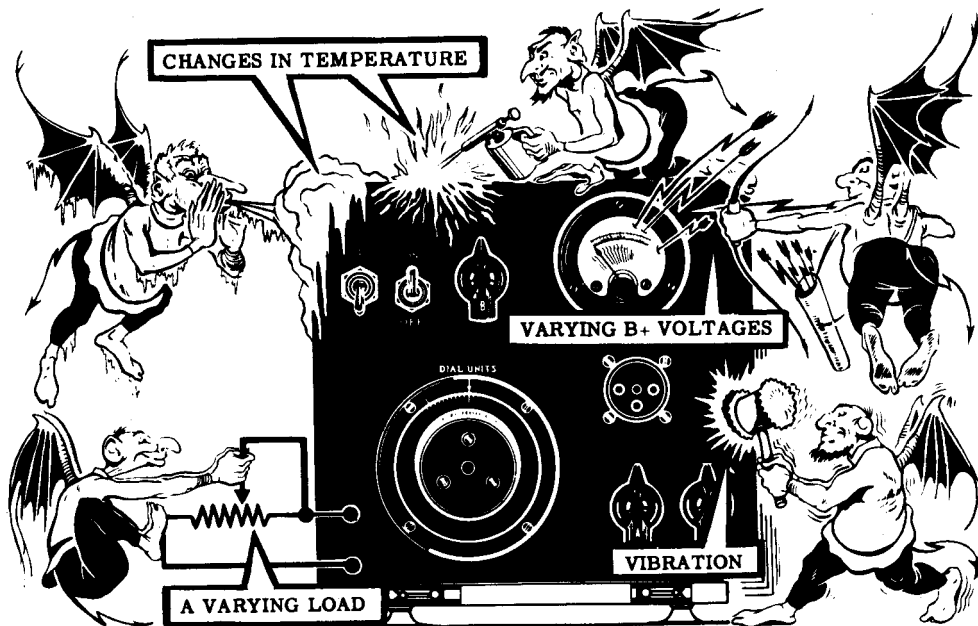

FACTORS WHICH CAUSE FREQUENCY SHIFTS IN OSCILLATORS.

# THE ARMSTRONG AND HARTLEY OSCILLATORS

## The Armstrong Oscillator

Basically all oscillators operate in the same way. Energy is coupled back, from the output to the tuned oscillating circuit on the input of the vacuum tube, in order to compensate for inevitable heat losses due to electrical resistance. If the losses are compensated for, oscillations continue. If you understand how oscillations are maintained in the Armstrong oscillator, you will understand the basic principles underlying all oscillators.

# ARMSTRONG

Feedback Path →

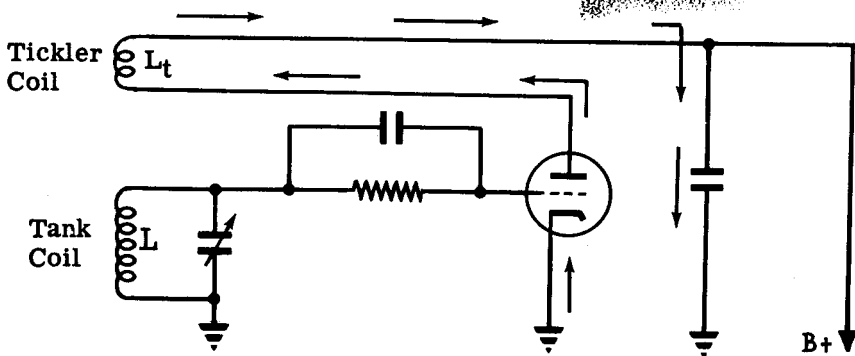

--- Oscillator

The Armstrong oscillator is like an RF amplifier with one modification: a coil has been introduced into the plate circuit. This coil is called the "tickler coil." It is wound adjacent to the LC tank coil (usually both coils are wound on the same coil form), so when plate current flows through this tickler coil,  $L_t$ , an emf will be induced into the tank coil  $L$ . Actually it is not DC plate current but variations in this DC current which produce the changing magnetic fields responsible for induced voltages across the tank coil. The induced voltage is the feedback voltage which sustains oscillation.

The Armstrong Oscillator (continued)

Grid Leak Bias

There is nothing complicated about the operation of the Armstrong oscillator. When the power supply is turned on, a flow of electrons surges from the cathode to the plate and through the tickler coil to B+. This surge of current causes a rapid buildup of a magnetic field around the tickler coil, and this expanding magnetic field suddenly induces a voltage in the coil of the LC circuit. This voltage surge in the LC circuit is sufficient to begin oscillations. All that the tube and tickler coil have to do from now on is give a voltage "kick" to the LC circuit at the proper time during the cycle of oscillation.

Notice that no cathode resistor or battery bias is used in the Armstrong oscillator circuit. The proper negative bias on the grid is obtained from the resistor and capacitor in the grid circuit. This method of obtaining bias is called "grid leak" bias. As you will very shortly see, the tube must be biased well below cut-off for most of its cycle of operation, which means that the tube is operating as a Class C amplifier. This high negative bias is maintained by means of the grid and the capacitor in the grid circuit. When plate current first begins to flow, there is no negative bias on the grid. This means that a very large plate current will flow through the tickler coil (causing oscillations to begin in the LC circuit), and in addition there will be a sudden pulse of electron current in the grid circuit. This flow of electrons causes a voltage to be developed across the resistor, and this voltage is such that the grid is strongly negative with respect to the cathode. The grid capacitor stores up enough electrons to keep the grid negative for nearly all of the cycle of oscillation. The charge on the negative side of the grid capacitor is strong enough to counterbalance a positive charge on the top plate of the LC capacitor. Only when the positive charge on the top plate of the LC capacitor reaches its maximum will it counterbalance the grid capacitor and cause plate current to flow.

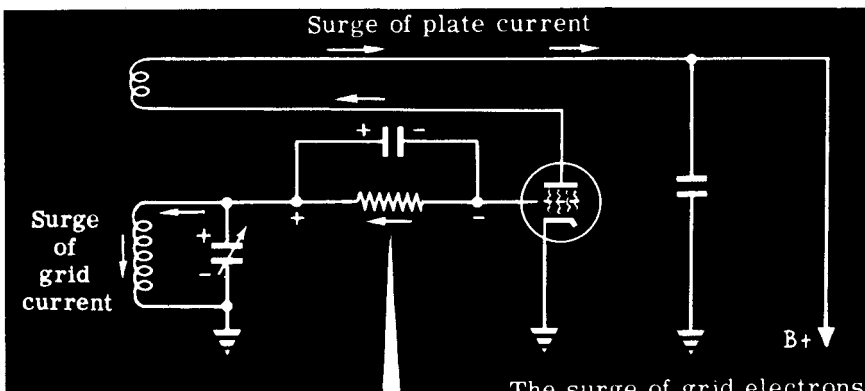

*Grid Leak Bias*

The surge of grid electrons causes a voltage drop across the resistor and makes the grid very negative with respect to cathode.

# THE ARMSTRONG AND HARTLEY OSCILLATORS

## The Armstrong Oscillator (continued)

### How Oscillations Are Maintained

Now that a cycle of oscillation has begun and the grid is negative with respect to the cathode, suppose you analyze what happens through an entire cycle of oscillation.

Begin your analysis at a time when the electrons are arriving on the top plate of the tuning capacitor after travelling through the coil from the bottom plate. At this time the negative charge on the grid capacitor is strong enough to counterbalance the decreasing positive charge on the top of the LC capacitor, and no plate current flows.

After the upper plate of the capacitor has reached its maximum negative charge, the electrons begin to flow back through the coil to the bottom plate. As the electrons begin to accumulate on the bottom plate, the top plate becomes more and more positive with respect to the bottom plate. The only thing that prevents the grid from becoming positive is the fact that all of the electrons on the charged capacitor have not leaked off through the grid resistor and the grid capacitor can still counteract the positive voltage at the top of the LC circuit. No plate current has flowed up to this time.

### OPERATION OF TUBE FOR MAJOR PART OF ONE CYCLE OF OSCILLATION

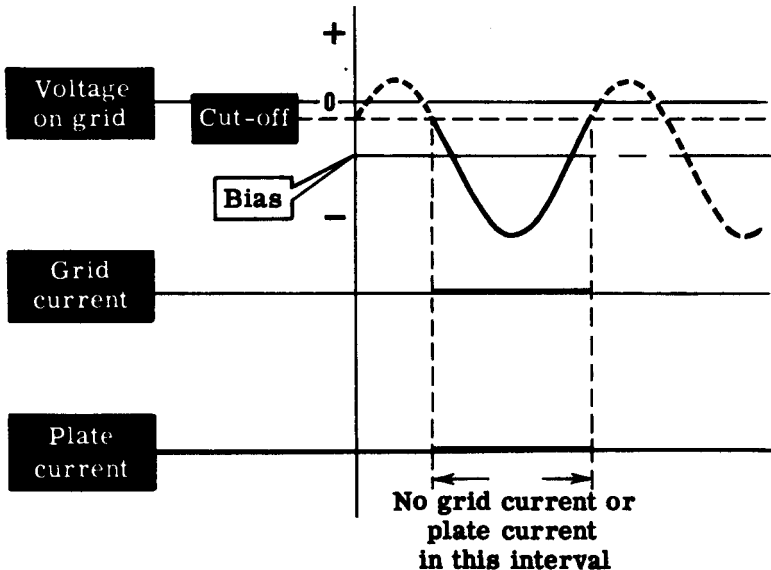
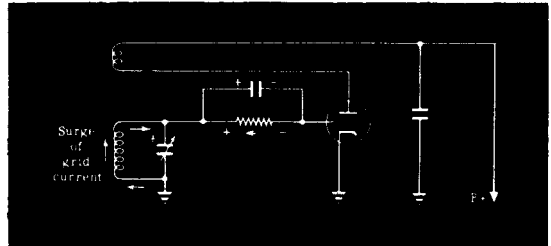

## THE ARMSTRONG AND HARTLEY OSCILLATORS

### The Armstrong Oscillator (continued)

#### How Oscillations Are Maintained

Finally the top of the LC circuit becomes so positive that it briefly overcomes the negative bias maintained by the grid capacitor. At this time plate current begins to flow and continues to flow for the interval that the top of the LC circuit remains strongly positive. This brief surge of plate current flows through the tickler coil and induces a brief voltage surge in the LC circuit. The tickler coil is wound in the same direction as the coil in the LC circuit, so this voltage surge is in such a direction as to give a "push" to aid the flow of electrons in the LC circuit. During the short interval that the top of the LC circuit is strongly positive, grid current begins to flow and causes the grid capacitor to regain its strong negative charge.

Immediately after the top plate of the LC capacitor reaches its peak positive value, electrons begin leaving the bottom plate of the capacitor on their way to the top plate. The negative charge on the grid capacitor is now strong enough to cut off all plate current and you are back at the point where you began your analysis. This cycle repeats itself over and over again.

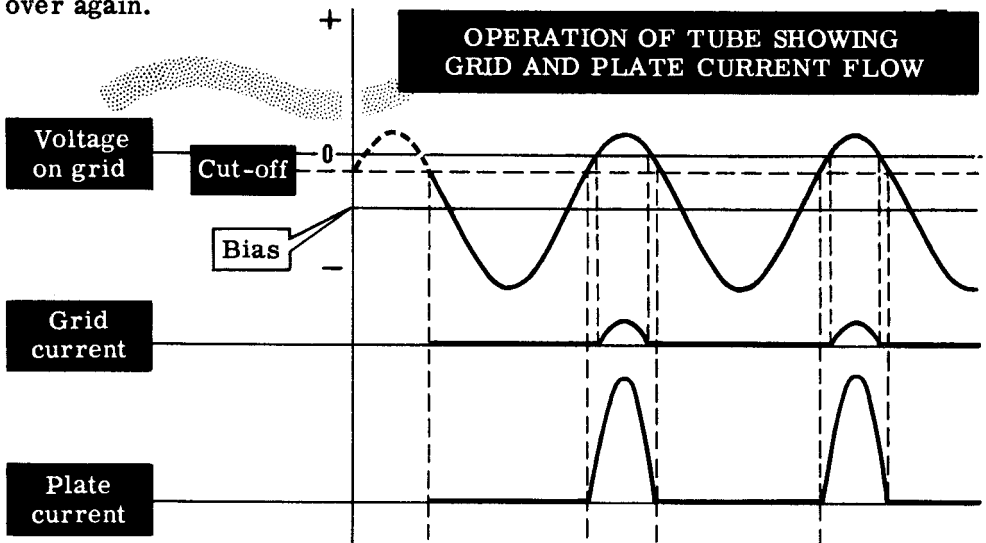

The tube, the grid resistor and capacitor and the power supply serve no purpose whatsoever during most of the cycle of oscillation. The LC circuit is the oscillator. All that these other components do is provide the means to give the LC circuit a voltage kick for a brief portion of the cycle. The "flywheel effect" keeps the electrons surging around the LC circuit with no other aid.

In order for oscillation to be sustained, the tickler coil must be able to induce enough voltage in the LC circuit to overcome the losses caused by the resistance of the LC coil. The proper amount of feedback is set by varying the number of turns on the tickler coil and by adjusting the distance between the tickler coil and the coil of the LC circuit. In order for the feedback voltage to be in the proper phase to aid the oscillator, the feedback coil must be wound in the same direction as the coil of the LC circuit.



# THE ARMSTRONG AND HARTLEY OSCILLATORS

## The Frequency of Oscillation

The most important thing to remember about oscillators is that the tank circuit does the oscillating; the tube merely supplies the pulses to keep the oscillations in the tank from dying down. Therefore, it should be obvious that the tank circuit determines the frequency of oscillation. Here is how this occurs.

You know that in any vacuum tube, the voltage on the grid controls the amount of plate current. If the voltage on the grid varies 1000 times per second, the plate current will have that many variations. If the plate current varies 1000 times per second, then the feedback pulses will be timed at the same rate. Now the question is: what started the oscillator off at this frequency in the first place?

The answer to that question is—the tank coil. When a pulse of current is delivered to a parallel-resonant circuit, the resonant circuit will start oscillating at its own resonant frequency. It doesn't matter what waveshape the pulse has; the tank will oscillate sinusoidally and at its natural resonant frequency, which depends on the value of L and C in the tank circuit. The larger L and C are, the lower the frequency. As L and C decrease, the frequency increases. Since it is more convenient to vary C than L, a variable capacitor is placed in the tank circuit to control the frequency of oscillation.

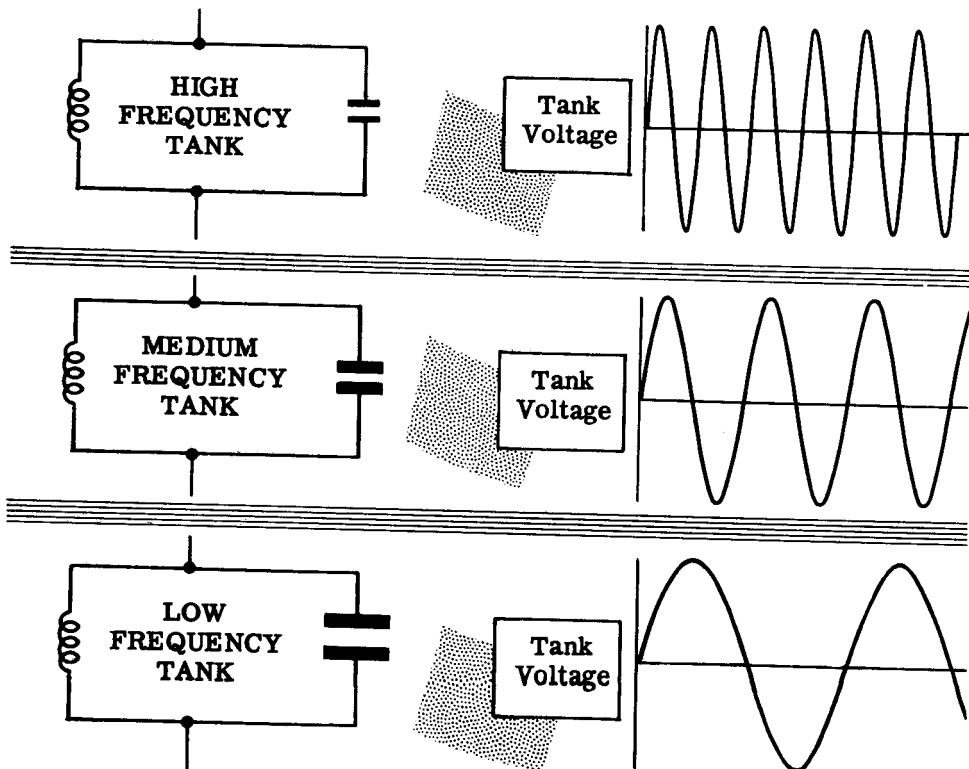

# THE ARMSTRONG AND HARTLEY OSCILLATORS

## Advantages of Grid Leak Bias

An important feature of the grid leak bias method used in the Armstrong oscillator is that it tends to make the oscillator self-adjusting. A random change in plate voltage affects the amplitude of oscillation, but high grid bias tends to reduce or cushion this effect. Here is how this cushioning effect acts:

1. If plate voltage rises, plate current increases through the tickler coil.
2. A larger emf is induced in the LC circuit.
3. The negative charge on the grid capacitor increases.
4. Plate current is reduced to its original level.

This grid bias tends to cancel plate current changes and reduce its effect on the LC tank.

Summing up the effects of grid leak bias: it permits high grid bias, permits oscillations to start, and tends to keep the strength of oscillation steady.

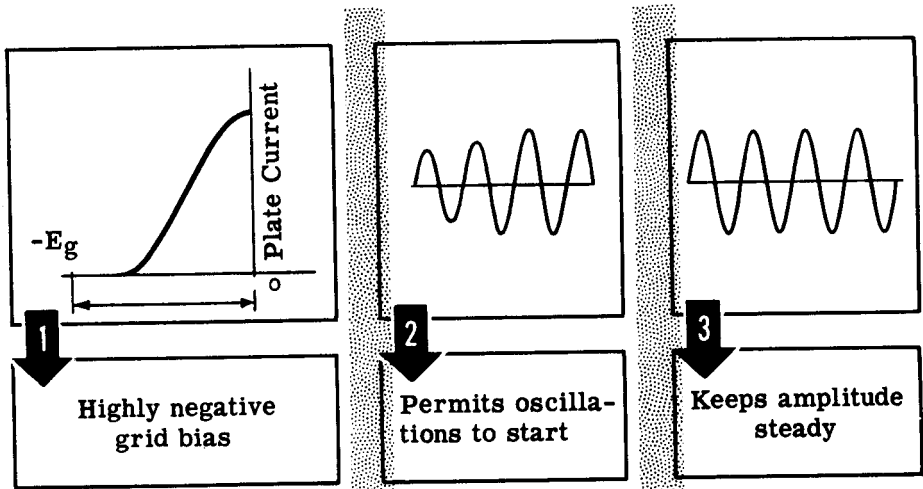

**summary: effects of grid leak bias**

Grid leak bias has one disadvantage. If oscillations should cease, even momentarily, the high negative grid bias would be lost. A large flow of electrons from cathode to plate would occur. This average plate current flow would be so large as to damage or ruin the vacuum tube.

# THE ARMSTRONG AND HARTLEY OSCILLATORS

## Frequency Instability

In your study of the Armstrong oscillator you have found out about a typical feedback circuit, an LC tank oscillator, and grid bias. Actually the Armstrong oscillator is rarely used, for it has several shortcomings, the most serious of which is frequency instability.

The tank consists of a coil and capacitor, and these determine its frequency of oscillation. However, this frequency of oscillation is subject to change due to other factors. Here are some of the factors which may cause a shift in frequency, and ways of eliminating them:

1. **Drawing Power from the Tank:** Load changes which draw power from the tank circuit, causing the tank voltage to drop, can be reduced by using an amplifier to separate the load from the oscillator.
2. **Changes in Plate Voltage:** Plate voltage can be kept constant by using voltage regulators.
3. **Vibration and Shock:** Shock absorbers and bonding on the circuit components reduce vibration.
4. **Hand Capacitance:** Grounding one side of the tank circuit or shielding the tank reduces the added capacitance introduced by the hands or other parts of the body when they pass by the tank circuit.
5. **Heat:** Heat effects can be eliminated by placing circuit components in thermostatically regulated compartments.

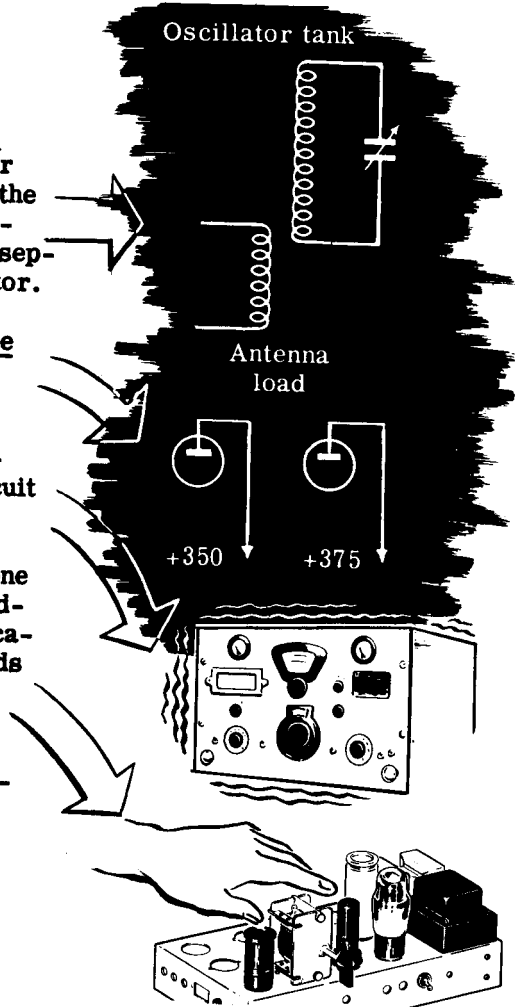

The importance of maintaining a stable frequency becomes apparent when you realize that most transmitting stations operate at one fixed frequency. At times it is essential that transmitter and receiver maintain constant twenty-four hour communications relations. If the frequency shifted, vital messages or parts of them might never be received.

The Hartley Oscillator

You are now going to learn about the Hartley oscillator. You will find that it represents an improvement over the Armstrong oscillator in the method of coupling. While it suffers from frequency instability, it has many favorable features, being adaptable to a wide range of frequencies and easy to tune. Since the Hartley oscillator is a widely used circuit, you should make sure that you understand it thoroughly.

# HARTLEY *Oscillator*

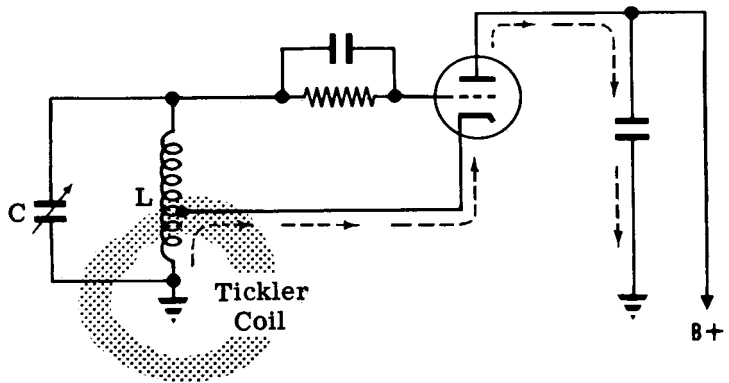

There is very little difference between the Armstrong and Hartley oscillators. In the Armstrong type, oscillations are sustained by a voltage kick induced in the LC circuit by a pulse of plate current through the tickler coil. In the Hartley type, the voltage kick is also induced in the LC circuit by a pulse of cathode current through the tickler coil. The unusual thing about the Hartley circuit is that the tickler coil is part of the coil which makes up the LC circuit. This single coil is tapped in such a way that the cathode current flows through the lower part of the coil and induces a kick voltage in the grid portion of the coil. The amount of feedback voltage induced can be adjusted by moving the cathode tap.

# THE ARMSTRONG AND HARTLEY OSCILLATORS

## How Oscillation Is Maintained in the Hartley Oscillator

Oscillations start when the B+ supply is turned on, because of the sudden rise in plate current. The DC current path is: flow of electrons from cathode to plate to B+, through the power supply to ground, up through L1 and so back to cathode. There is no grid bias, initially, to block the flow of plate current. This initial surge of current through L1 induces a voltage kick in L2 and oscillations begin. In the meantime, a pulse of grid current has charged the grid capacitor highly negative in exactly the same manner as in the Armstrong oscillator.

## HARTLEY Oscillator

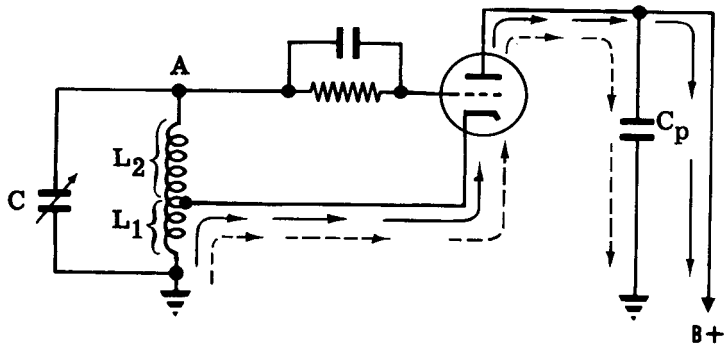

... Showing DC current path and RF feedback path  
—→ DC    - - - -> RF

Once oscillation has begun, the cycle is very much the same as in the Armstrong oscillator. The tube is biased below cut-off from shortly after the top plate of the LC circuit, point A, has reached its peak positive value until shortly before it reaches its peak positive value again. During all this time the tube serves no purpose whatsoever, and the surge of electrons through the tank circuit goes on solely because of the flywheel effect of that LC circuit.

When the electrons in the tank circuit begin to pile up on the lower plate of the capacitor, the upper plate becomes more and more positive. For the brief interval that the top plate of the LC circuit is at its peak positive voltage, this positive voltage is able to counteract the negative bias caused by the grid capacitor. During the brief instant that the grid remains positive, a pulse of cathode current flows and induces a voltage kick in L2. The flow of grid current recharges the grid capacitor highly negative and the cycle begins over again.

# THE ARMSTRONG AND HARTLEY OSCILLATORS

## The Colpitts Oscillator

The third basic oscillator you will learn about is the Colpitts oscillator. It is versatile, easy to operate, adaptable to a wide range of frequencies and has somewhat better frequency stability than the Hartley oscillator. It is very much like the Hartley, but uses tapped capacitance in place of the Hartley's tapped inductance for feedback. The two are compared below.

## COLPITTS Oscillator

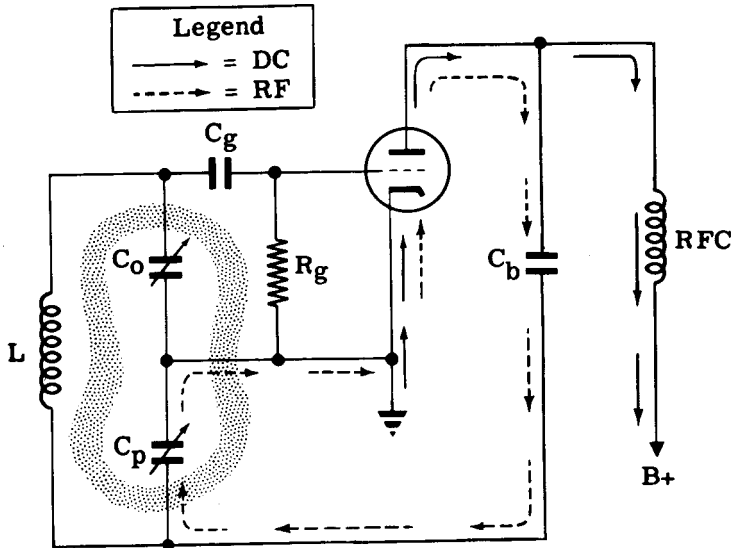

## *the* HARTLEY

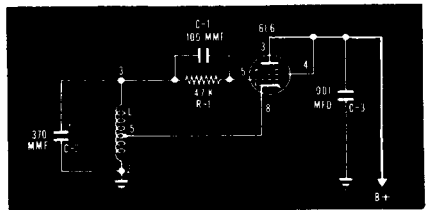

The DC current path is: electron flow from cathode to plate, through the RF choke to B+, through the power supply to ground, back to cathode.

AC current is coupled back to the tank by means of the coupling capacitor Cb; and Cp is the AC plate load across which the feedback voltage is developed. Feedback current begins due to the first rise in plate current. The amount of feedback depends on the ratio of Cp to Co. Proper phasing of oscillation is obtained with the grid and plate at opposite ends of the tank, using a condenser, Cb, for feedback of RF voltage. The current oscillates in the tank circuit consisting of LCpCo, and the reactance of the coil and two capacitors determine the oscillating frequency.

# THE ARMSTRONG AND HARTLEY OSCILLATORS

## Review

All vacuum tube oscillators, whether RF or audio, work on the principle of feeding back voltage pulses from the plate circuit to the grid circuit of the tube. The grid is connected to a parallel resonant circuit which does the oscillating. The parallel resonant circuit also times the pulses fed back, and thus controls the frequency of oscillation. The tube is generally operated Class C, so that plate current flows in pulses (during less than half of the AC cycle).

**THE ARMSTRONG OSCILLATOR**—uses a tickler coil to feed back pulses from the plate circuit to the tank circuit.

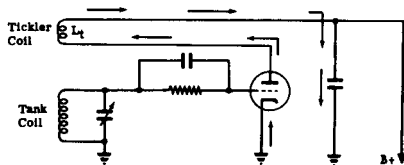

**HARTLEY OSCILLATOR**—uses a tapped coil instead of a separate tickler winding to feed back pulses. It has more frequency stability than the Armstrong.

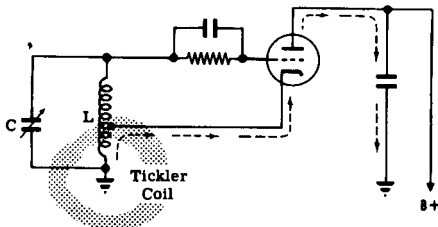

**COLPITTS OSCILLATOR**—uses a tapped capacitance network to couple the feedback pulses to the grid tank circuit. It has more frequency stability than the Hartley oscillator.

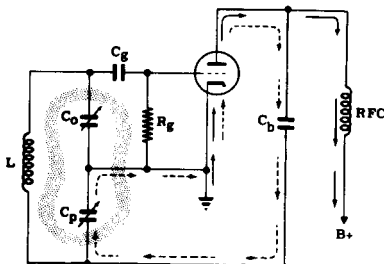

**GRID LEAK BIAS**—a method of bias in which excess electrons accumulate on the grid, producing a negative bias. They are allowed to leak off slowly through a large resistor which is placed in parallel with the grid capacitor or from grid to cathode. Making the resistor large enough produces more than cut-off bias and results in Class C operation.

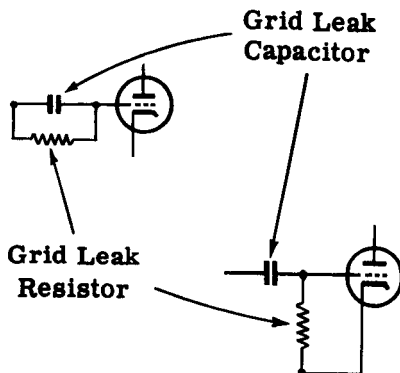

# THE TUNED-PLATE TUNED-GRID AND CRYSTAL OSCILLATORS

## Introduction

The tuned-plate tuned-grid oscillator (TPTG) is an oscillator which is not widely used as such, but one whose principles are employed in the crystal oscillator which you will learn about a little later.

The distinctive feature of the TPTG is the fact that the output as well as the input circuit is tuned. Also distinctive is the fact that no coupling capacitor or coil is necessary if a triode is used.

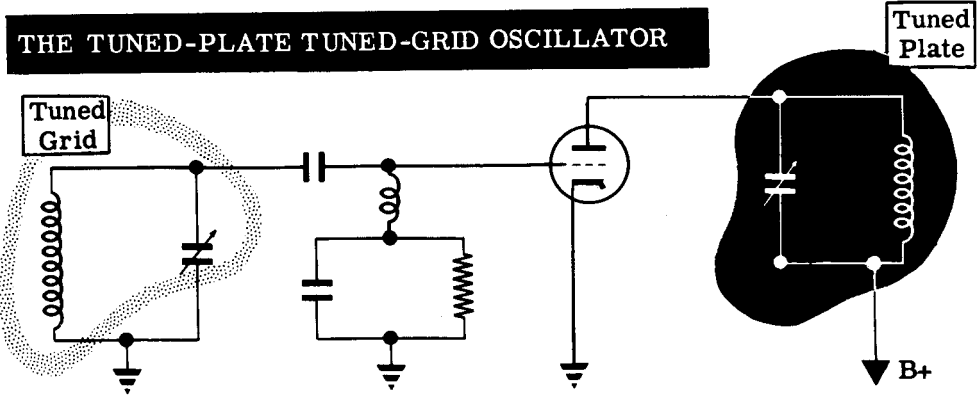

Feedback is accomplished without using either capacitor or coil to couple the energy back. To prove this, suppose you start with the above circuit, but with a pentode tube in place of a triode and use link coupling to feed back energy from plate to grid tuned circuit.

**A**

**PENTODE WITH LINK COUPLING**

*For Feedback*

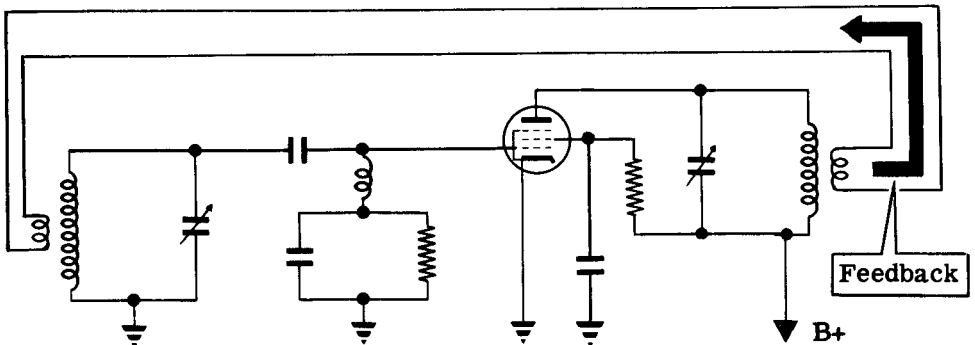

With sufficient coupling, feedback energy will compensate for resistance loss in the grid tank and oscillation will continue.



# THE TUNED-PLATE TUNED-GRID AND CRYSTAL OSCILLATORS

## Feedback in the TPTG Oscillator

Replace the link coil with a small capacitor, say of 3 mmf capacity. This capacitor will provide the feedback.

Now you are ready to compare this circuit, containing a pentode with capacitor feedback, to a circuit containing a triode but without capacitor feedback.

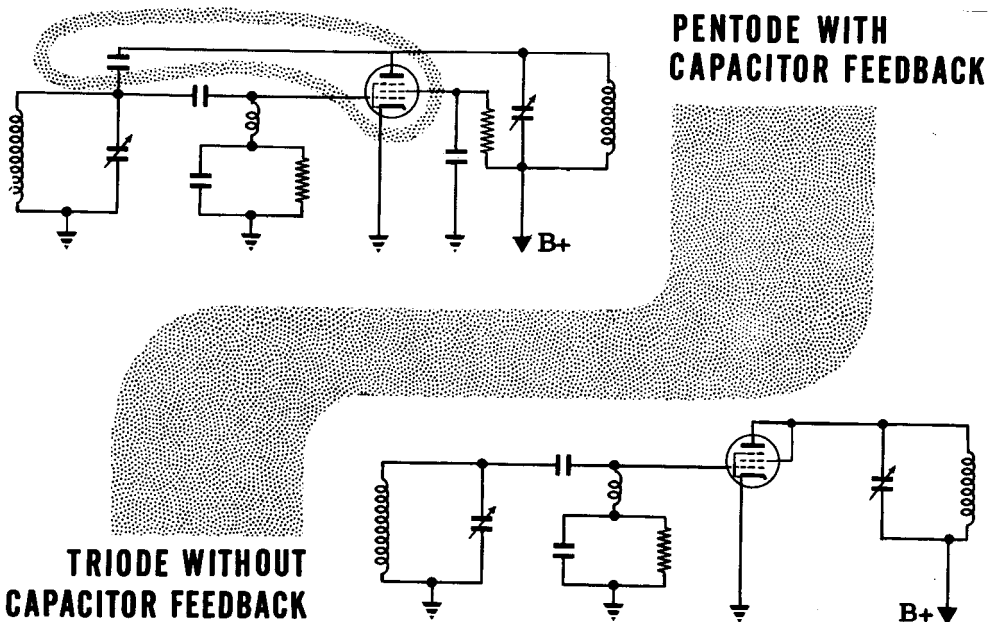

The pentode with capacitor feedback will support oscillation. The triode without capacitor feedback will support oscillation because it, too, provides feedback: not through an outside capacitor but through the capacitance between the plate and the grid of the triode. The pentode has such a low plate-grid electrode capacitance that an added capacitor is needed. The triode has more plate-grid capacitance and doesn't require an added capacitor. Both employ capacitance feedback.

$$\text{Pentode} + \text{Capacitor} = \text{Triode} + \text{Plate-Grid Capacitance}$$

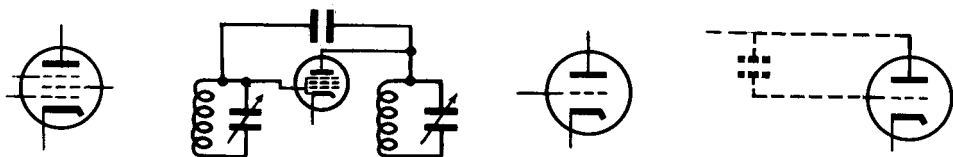

Thus you can see that feedback to sustain oscillation can be accomplished without the use of coil or capacitor. The internal capacitance of tube elements provides the feedback.

# THE TUNED-PLATE TUNED-GRID AND CRYSTAL OSCILLATORS

## Introduction to Crystal Oscillators

The crystal-controlled oscillator, or simply the crystal oscillator, is very widely used because it has one quality which none of the previously studied oscillators has—high frequency stability. Crystals have very many uses apart from their use in oscillators, being found in many receivers, microphones and loudspeakers. The crystals most commonly used in radio transmitters are quartz, tourmaline and Rochelle Salts.

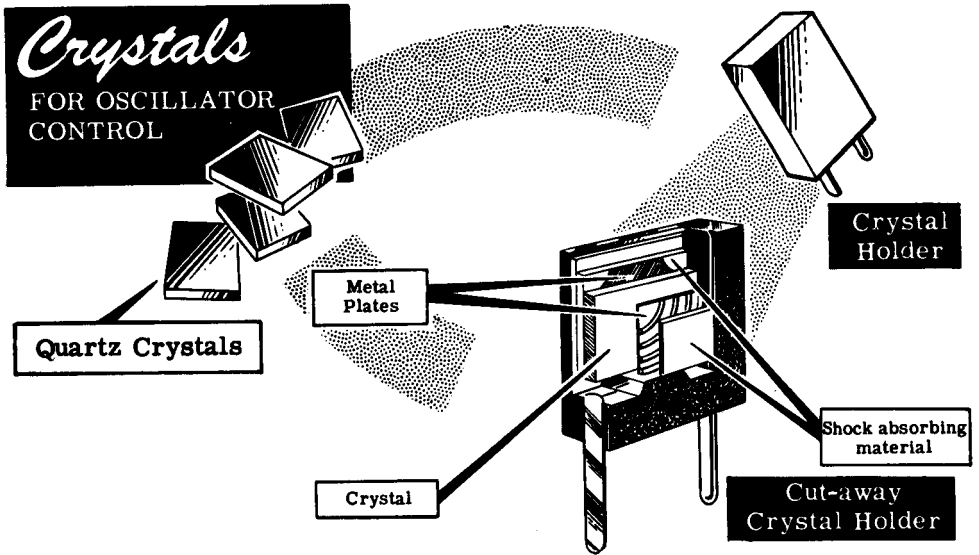

These crystals exhibit what is known as the piezoelectric effect. If a block of quartz is placed between two metal plates and pressure is applied, then a voltage difference will appear across those two plates. Also, if an AC voltage is applied across the two plates, the crystal will stretch and compress. Thus the crystal can convert mechanical energy into electrical energy and electrical energy into mechanical vibration.

### CHANGING ELECTRICAL ENERGY INTO MECHANICAL ENERGY

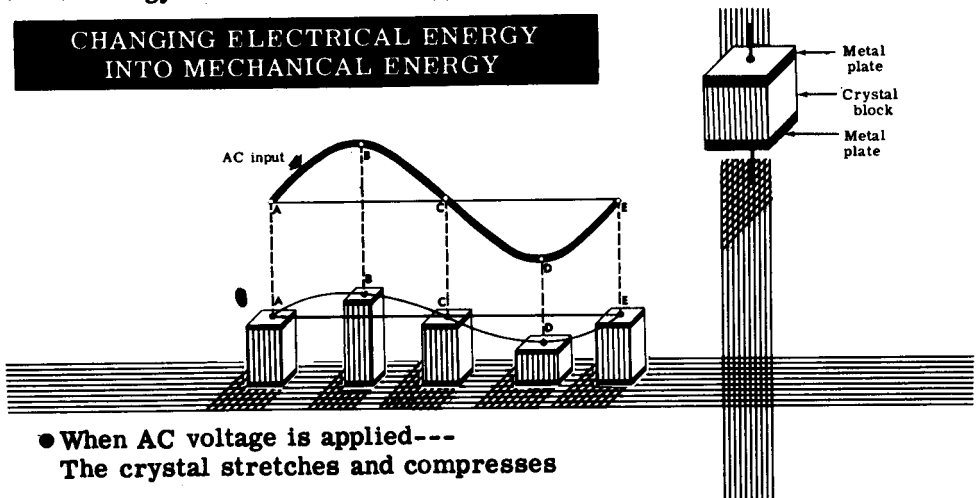

# THE TUNED-PLATE TUNED-GRID AND CRYSTAL OSCILLATORS

## The Crystal as a Resonator

A crystal has a natural frequency of vibration. When the AC voltage across its faces has the same frequency as the mechanical frequency of the crystal, the crystal block will stretch and compress more than for other frequencies. Also, the crystal's natural frequency of vibration is extraordinarily constant, more constant even than the frequency of oscillation in an LC circuit.

### EQUIVALENT TO A SERIES-RESONANT CIRCUIT

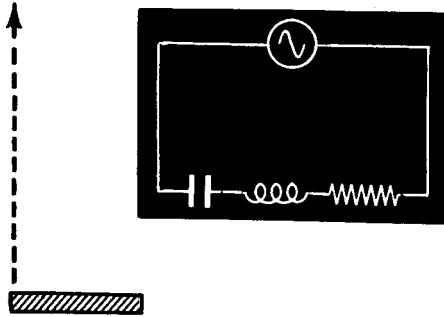

The Crystal

### EQUIVALENT TO A PARALLEL- RESONANT CIRCUIT

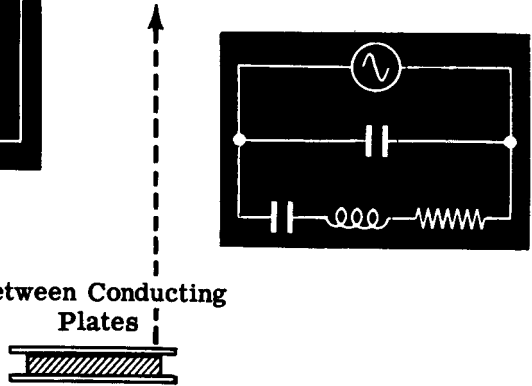

Between Conducting  
Plates

Taken by itself, the crystal acts like a series-resonant circuit. Together with its two plates, it acts like a parallel-resonant circuit. The frequency at which it vibrates depends on its thickness. Thick crystals vibrate slowly, thin crystals vibrate rapidly.

For protection from mechanical shock, crystals have been placed in sealed containers or holders. Don't drop them. Crystals should be protected from electrical shock, too. Excessive voltage causes them to crack or overheat. The RF current flowing through the crystal should not exceed 100 milliamperes.

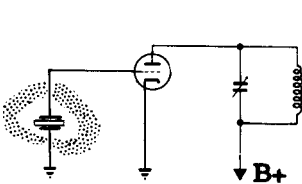

### THIS IS THE EQUIVALENT ELECTRICAL CIRCUIT

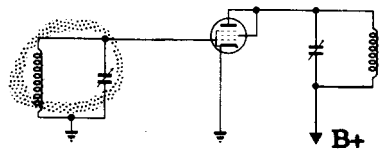

*A Crystal*

can take the place of... A TUNED CIRCUIT

# THE TUNED-PLATE TUNED-GRID AND CRYSTAL OSCILLATORS

## The Crystal Oscillator Circuit

Where power output is not the most important consideration and where only one fixed frequency is to be used, the crystal oscillator is a highly satisfactory circuit. It overcomes one defect which all previous oscillators have suffered from, namely, its frequency is not influenced by changes of load.

The basic crystal oscillator uses a crystal as a mechanical resonator, in place of the tuned-grid capacitor and inductor in a TPTG oscillator.

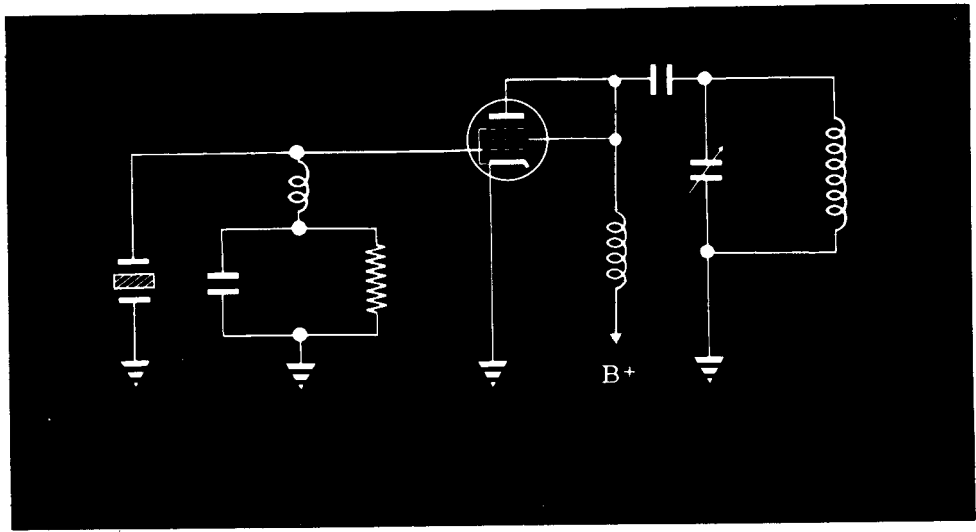

This circuit behaves like the TPTG oscillator in every respect. Feedback is obtained through the plate-grid capacity of the vacuum tube or by using a small feedback capacitor. This voltage feedback causes the crystal to vibrate mechanically at its natural frequency. When the crystal vibrates, an emf appears across the electrodes on the two faces of the crystal. This emf is applied to the grid. The changing emf on the grid controls the flow of plate current and hence the amount of feedback.

Amount of coupling and, therefore, amplitude of oscillation and power output depend on tuning the plate tank to a higher frequency than the natural frequency of the crystal. If the plate tank should be tuned to a lower frequency, feedback through the plate-grid capacity would be out-of-phase with the grid oscillations, and oscillation would cease.

Tuning the Crystal Oscillator

To tune the crystal oscillator you tune the plate tank capacitor, starting with the capacitor set for maximum capacity. A plate current meter indicates a high plate current, as is to be expected when the grid tank is not oscillating. This plate current suddenly drops to point A, indicating that the plate is at the same resonant frequency as the crystal circuit, hence feedback is at a maximum and oscillations are very strong. The capacitor is tuned past this point to the region B-C, where plate current has risen and the plate tank is higher in frequency than the grid crystal oscillator. Some power is sacrificed for stable oscillations, since at point A any small change in the direction of lowered frequency would cause the crystal to stop vibrating.

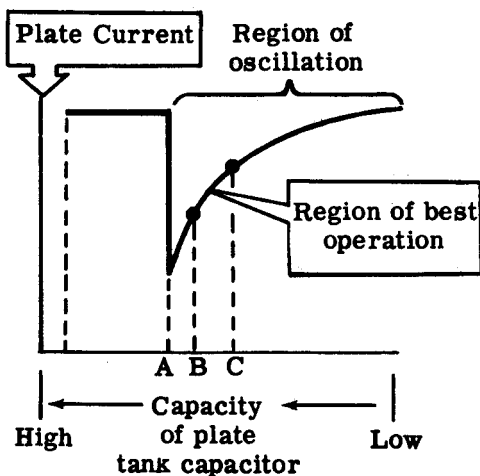

**TUNING THE CRYSTAL OSCILLATOR**

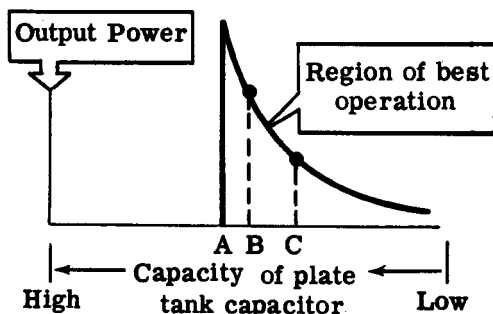

Since a crystal has low frictional losses, it doesn't require much feedback to sustain oscillations. Besides, a large amount of voltage across the crystal plates can make the crystal vibrate so hard as to overheat or shatter—much as a powerful explosion causes window panes to vibrate so strongly as to shatter. Overheating causes frequency drift. Thus, smaller feedback results in a greater safety factor and in less frequency drift.

Since a pentode tube has very low grid-plate capacity, it may be used in a high frequency crystal oscillator to lessen the amount of feedback. This allows the crystal to do less work while still controlling the frequency of oscillation. Such a circuit has still less frequency drift than a triode crystal oscillator and is often used when very precise frequency measurements are being made.

However, the pentode crystal oscillator suffers from certain disadvantages. At low frequencies, the low grid-plate capacity of the pentode does not allow enough feedback to sustain oscillations. Therefore, some external grid-plate capacity must be inserted. The crystal oscillator you will build avoids this difficulty by connecting the oscillator tube as a triode.

# THE TUNED-PLATE TUNED-GRID AND CRYSTAL OSCILLATORS

## Analysis of the Crystal Oscillator

The crystal oscillator is a TPTG oscillator in which a crystal substitutes for the conventional tuned capacitor and inductor. The 6L6 tube (see figure) is used as a triode. Thus the grid-plate capacity is much higher than if the tube were connected as a pentode. This increases the amount of feedback and makes the crystal "work harder." It is possible to use a pentode in a crystal oscillator, but such an oscillator is more complicated and sometimes more difficult to adjust. To avoid the possibility of this difficulty, the 6L6 is connected as a triode.

### The Crystal Oscillator

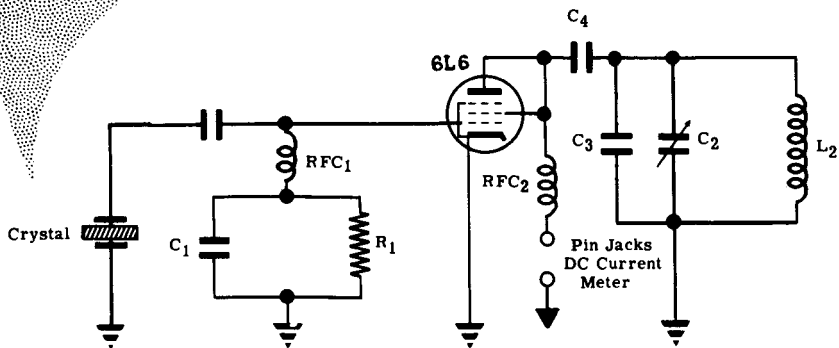

$C_3$  in parallel with  $C_2$  adds to its capacity and reduces the resonant frequency. This is required if the range of  $C_2L_2$  alone does not extend down to the crystal frequency.

$RFC_2$  is the plate choke which keeps the RF out of the power supply and forces it into the tank circuit.  $C_4$  is the blocking capacitor which keeps the DC plate voltage out of the tank circuit but allows the RF to get through.

The grid capacitor  $C_1$  and resistor  $R_1$  bias the grid. These are in shunt rather than in series with the crystal in order to keep down the amount of voltage across the plates of the crystal power input. Shunt feed is used, through the inductor  $L_2$  to plate of the tube.

$RFC_1$  is the grid choke which keeps down the current flow in the crystal circuit. In the absence of  $RFC_1$ , the RF being generated by the crystal would be shorted by  $C_1$  to ground. An excessively large current would flow in the tank circuit, causing the crystal to vibrate so strongly as to overheat, and possibly crack or shatter.

# THE TUNED-PLATE TUNED-GRID AND CRYSTAL OSCILLATORS

## Review of TPTG and Crystal Oscillators

**THE TPTG OSCILLATOR**—uses a tuned circuit in both the plate and grid circuits. Maximum power output is obtained when the plate tank circuit is tuned to the same resonant frequency as the grid tank circuit.

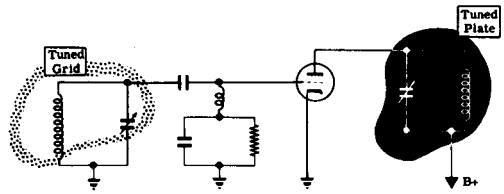

**FEEDBACK**—can be provided by means of link coupling or a capacitor when a pentode is used. The plate-to-grid capacitance provides feedback when a triode is used.

Pentode + Capacitor

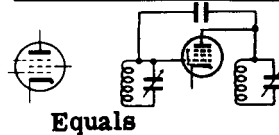

Triode + Plate-Grid Capacitance



**A CRYSTAL**—with its conducting plates is equivalent to a parallel resonant circuit, and can be used in place of the grid tank circuit of the TPTG oscillator.

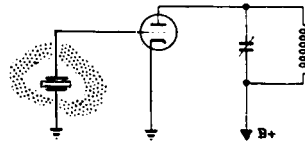

**CRYSTAL OSCILLATOR**—is very similar to the TPTG oscillator, but uses a crystal in place of the grid tank circuit. Power output is low, but frequency stability is excellent where only one frequency is required.

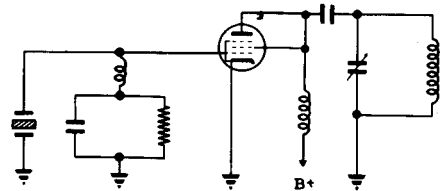

**POWER OUTPUT**—of the crystal oscillator is maximum when the plate tank is tuned to the natural mechanical frequency of vibration of the crystal. The oscillator is usually operated at less than maximum power output to achieve stability of operation.

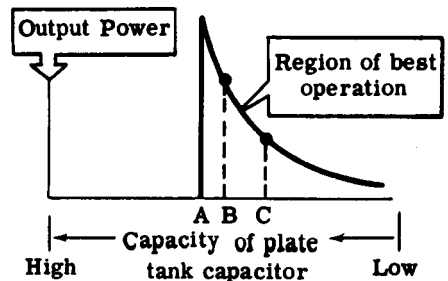

# THE ELECTRON-COUPLED OSCILLATOR

## Introduction to the Electron-Coupled Oscillator

The Colpitts and Hartley oscillators are good all-round oscillators, but they do not quite meet the needs of good frequency stability. The crystal oscillator has good frequency stability, but it is limited to relatively low power output and to a single frequency of operation plus its harmonics. What is still needed is an oscillator having good frequency stability in addition to high power output and a wide operating range. One which meets all three conditions is the electron-coupled oscillator. As a result, it is very widely used, at moderate frequencies, in transmitters.

Below is the basic circuit of the electron-coupled oscillator, or ECO.

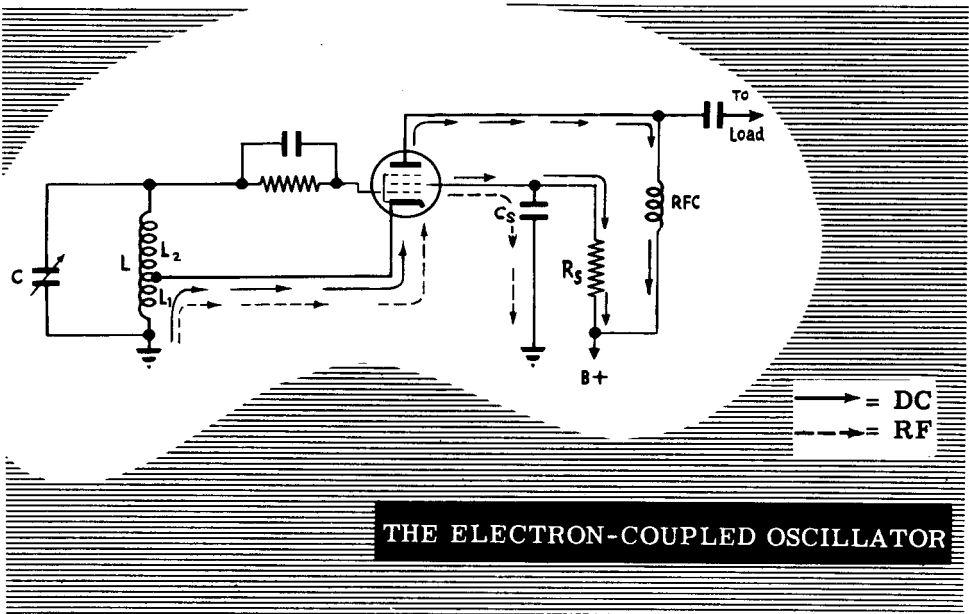

You can see that this is a modified Hartley oscillator. The modification consists in the replacement of the triode by a tetrode, which has an additional element, the screen grid.

As in the Hartley, current feedback across  $L_2$  starts the cycle of oscillation and then sustains it in the LC tank. As in the Hartley, too, the amount of feedback depends on the ratio of  $L_1$  to  $L_2$ . Thus the method of feedback is the same.

DC current flow is substantially unchanged except that a screen circuit appears in parallel to the plate circuit as shown by the arrows in the diagram. The screen grid draws a very small portion of the total current since a dropping resistor,  $R_s$ , places it at a much lower potential than the plate. This screen current represents a small power loss, reducing the efficiency of the circuit somewhat. Screen current may be about three ma. as compared to approximately sixty ma. in the plate circuit.



# THE ELECTRON-COUPLED OSCILLATOR

## The ECO Circuit

In the electron-coupled oscillator, the cathode, control grid and screen grid form a series-fed Hartley oscillator with LC as its oscillatory circuit. The screen grid serves as the plate of the oscillator. The screen draws only a small portion of the electron stream through the tube—only enough to support oscillation. This RF current is coupled back to the oscillator tank through  $C_S$ , the screen grid RF bypassing capacitor.

### ECO EQUIVALENT OF HARTLEY OSCILLATOR

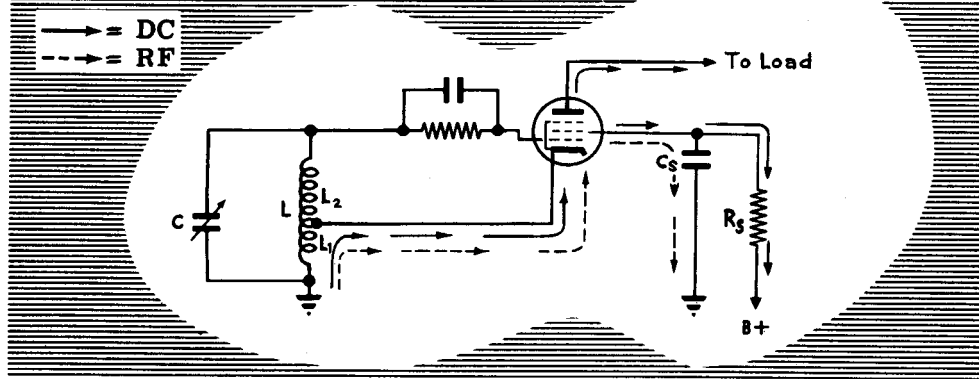

From the diagram it can be seen that both DC and RF paths are identical with DC and RF paths in the Hartley oscillator.

There are two consequences to these changes in feedback:

1. It means that the plate has been isolated from the LC circuit connected to the tube. The screen, being effectively grounded for RF potentials by capacitor  $C_S$ , shields the plate from the portions of the tube connected to the LC circuit. The plate is only an output electrode to the load.

It also means that many electrons will pass through the positive screen because they are attracted to the more positive plate. The electron current going to the plate is increased and decreased by the action of the grid, but the plate has no significant effect upon this electron current. Therefore the plate current will have an AC component due to the oscillator, this AC component being of the same frequency as that of the oscillator. Thus energy is delivered to the load through the electron stream within the tetrode—the coupling medium is the electron stream, hence the name "electron-coupled oscillator."

2. For the oscillator, it means that this section has been shielded from what occurs in the output or load circuit. Therefore, changes of load impedance will not affect the oscillator. Also, so long as the ratio of plate and screen voltages remains the same—which is assured by taking both from the same source through a voltage divider—voltage on the plate cannot affect the oscillator.

# THE ELECTRON-COUPLED OSCILLATOR

## The ECO Circuit (continued)

From the diagrams, it can be seen that in the Hartley oscillator—and in the other oscillators, except the crystal oscillator using a tetrode—the LC tank determines the frequency of oscillation and supplies power to the load. Hence, any change of load was reflected into the LC circuit and produced a frequency shift. In the ECO, the LC tank determines the frequency but the plate delivers power to the load. So load changes are not reflected back into the LC tank.

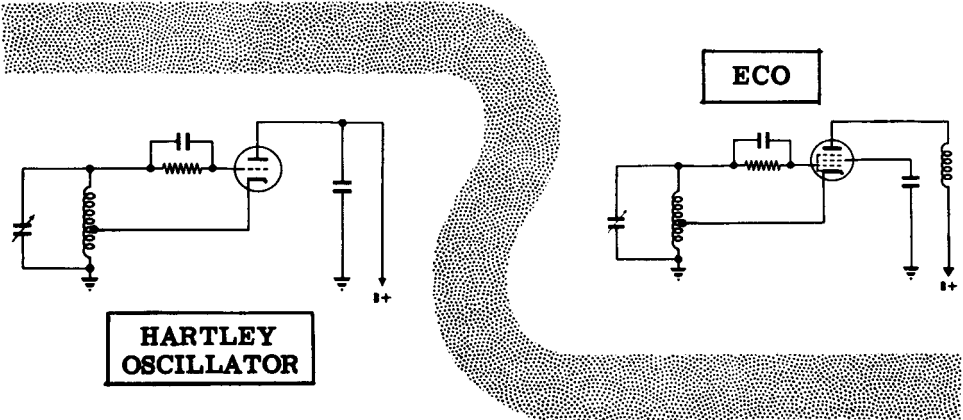

The oscillator section of the electron-coupled oscillator may be a Colpitts circuit instead of a Hartley circuit with equally satisfactory results. The "electron-coupling" effect refers to how energy is delivered from oscillator to plate circuit, not to how the oscillations are generated.

The only difference between the Colpitts ECO and the Hartley ECO lies in the feedback circuit to sustain oscillation. Capacitance, instead of inductance, is tapped.

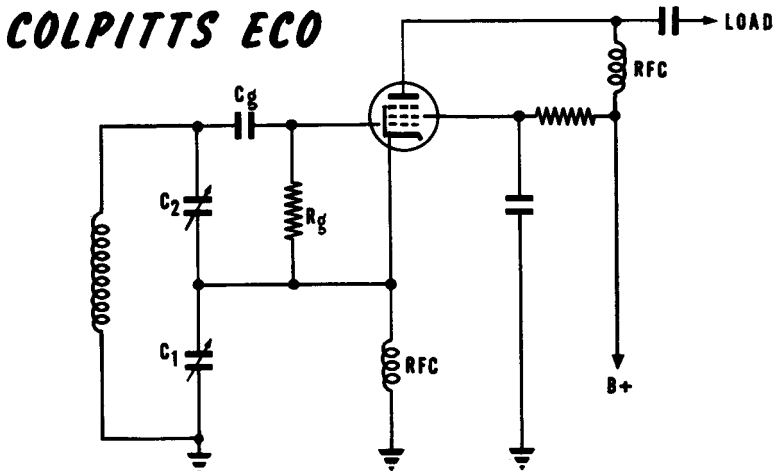

## THE ELECTRON-COUPLED OSCILLATOR

### Analysis of the ECO

Shown below is a Colpitts type ECO. Its operation is almost identical with that of the Hartley ECO which was explained previously.

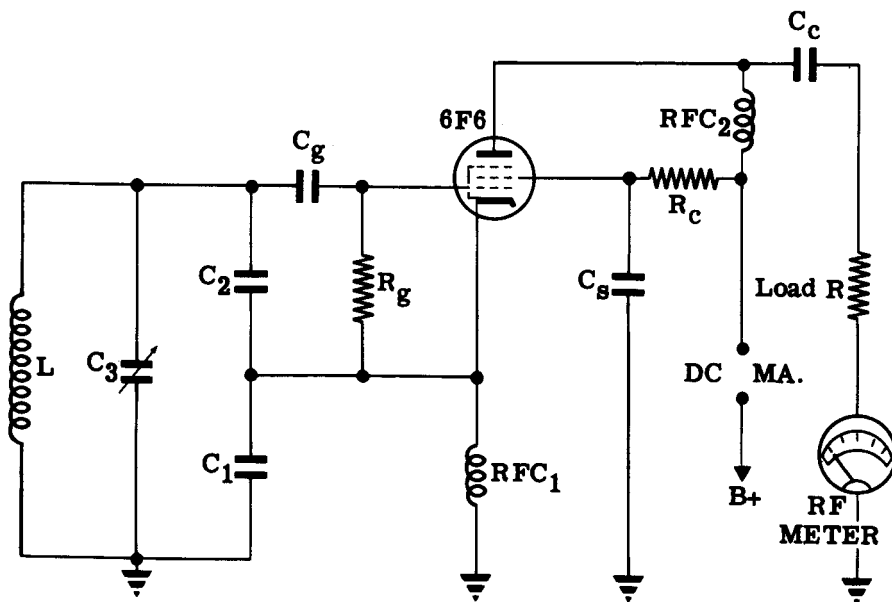

A pentode connected as a tetrode is used in place of the triode of the Colpitts oscillator. The cathode, control grid and screen, along with the tank circuit, act as a conventional Colpitts oscillator. The screen RF bypass capacitor,  $C_s$ , shields this triode from the plate and supplies feedback across  $C_1$ , the AC screen grid load.

The tank circuit is  $C_1$ - $C_2$ - $C_3$ - $L$ .  $C_3$  has been placed in parallel with  $C_1$ - $C_2$  so that the tank can be tuned without changing the ratio of  $C_1$  to  $C_2$ .

$RFC_1$  is necessary for oscillations to be sustained. It prevents an RF short circuit from  $C_s$  back to cathode, in which case feedback would never reach the tank circuit.

Most of the electrons leaving the cathode reach the plate which is at a higher potential than the screen grid. The AC component of plate current is coupled to the load by capacitor  $C_c$ , while  $RFC_2$  blocks this same AC (RF) current from the B+ supply. Thus the plate of the tube acts as an output electrode, its function being to deliver power to the load. Electron coupling within the tube delivers power to the plate circuit. This does not alter the way in which feedback is coupled back to sustain oscillations.

The Colpitts type ECO is relatively immune to changes of load and plate voltage.

# MISCELLANEOUS OSCILLATORS

## Variations in Oscillators—Series and Shunt Feed

In previous topics you examined the Armstrong, Hartley, electron-coupled, Colpitts, tuned-plate tuned-grid, and crystal oscillators. Each one of the circuits you have already studied can be set up in a number of ways. Then there are probably a dozen other types of oscillators, each of which may be connected in a number of ways.

The reason for all these oscillator circuits is that various circuits have different advantages as well as disadvantages. Certain oscillators are more stable than others. Some are less affected by loading. Others are just simpler, and thus easier, to include in the equipment for which they are designed.

One possible variation in an oscillator circuit is the choice between series feed and shunt feed. Series feed is a hookup in which the plate current flows through the tank coil. In shunt feed, the plate current flows through an RF choke, and only RF current flows through the tank. Here is how the Hartley oscillator is connected for series feed and shunt feed. Nearly every other oscillator circuit may be varied in a similar manner.

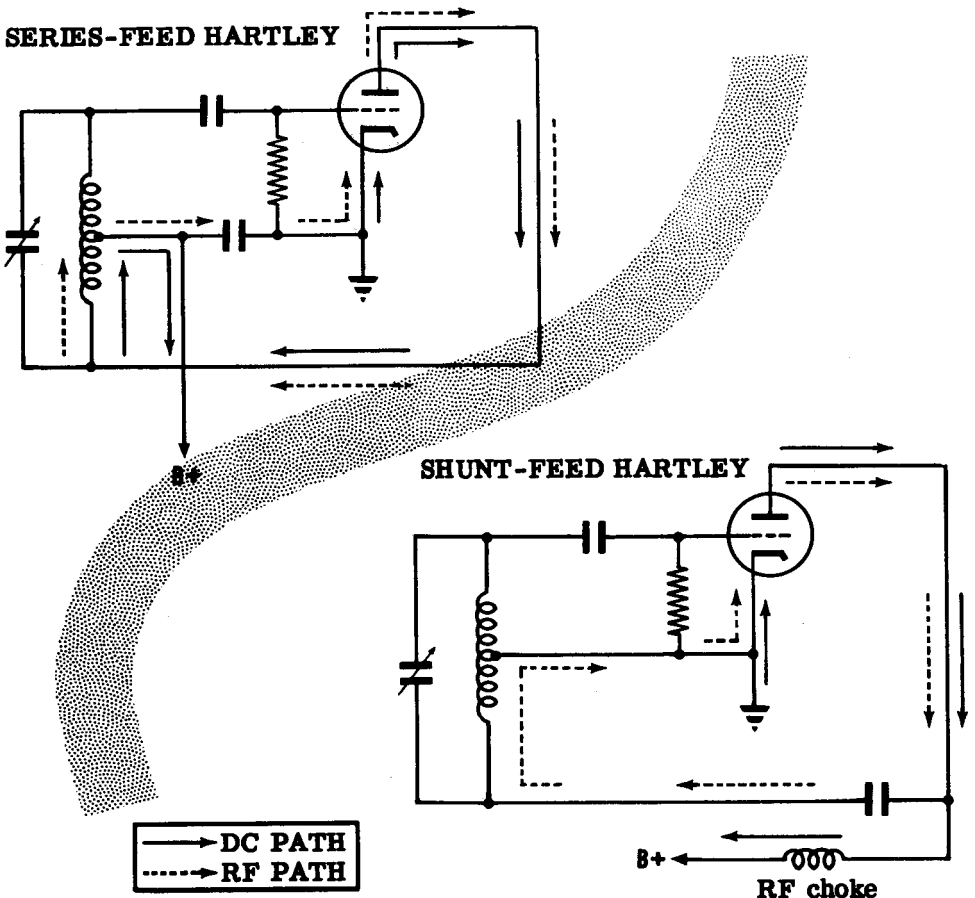

## MISCELLANEOUS OSCILLATORS

### Variations in Oscillators—RF Ground Potential

Any point in an oscillator or RF amplifier circuit which has a high impedance to ground with respect to RF is said to be "above RF ground potential." Any point which presents a low impedance to ground for RF current is said to be "at RF ground potential."

Below, you see a circuit of a Hartley oscillator. You will notice that the cathode does not go directly to ground. There is a coil between the cathode and ground. This coil presents some impedance to RF. Therefore, the cathode is not at ground potential with respect to RF. It is above RF ground potential.

#### RF Potential in the Hartley Oscillator

Above RF ground potential

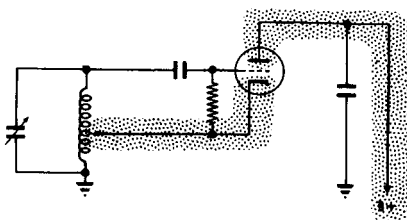

At RF ground potential

There is a capacitor between the plate of the Hartley oscillator and ground. This capacitor offers a very low impedance path for RF. Since it goes to ground, the plate is considered at RF ground potential, even though it is at a high DC potential.

A circuit diagram of the Armstrong oscillator is shown below. The cathode is at RF ground potential. It has a low impedance connection to ground—a wire. The plate is above RF ground potential because it is connected to B+ through a coil and B+ is always at RF ground potential.

Above RF ground potential

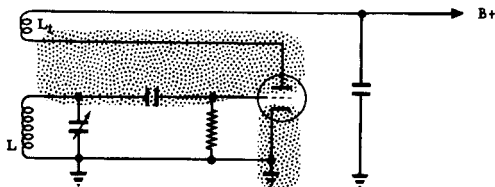

At RF ground potential

RF Potential in the Armstrong Oscillator

The grid of the Armstrong oscillator is above ground potential even though there is a capacitor between grid and ground. This is because the capacitor is connected across a coil. The combination of capacitor and coil form a parallel-resonant circuit which has a high impedance to RF at its resonant frequency. The Armstrong circuit oscillates at the resonant frequency of the tuned circuit. Therefore, as long as the circuit is oscillating, there is a high impedance from grid to ground so that the grid is above RF ground potential.

# MISCELLANEOUS OSCILLATORS

## Variations in Oscillators—Different Grounding Points

You have already seen that the Hartley oscillator may be connected for series or shunt feed. You probably noticed that the cathode goes directly to ground in both circuits. Any oscillator using a triode must have at least two of its three electrodes (cathode, grid and plate) above RF ground potential. The third electrode may be at RF ground potential. This produces three more variations in an oscillator circuit. These variations are illustrated below in the Colpitts circuit. The three hookups shown use shunt feed. Most other oscillators can be connected with the cathode, grid, or plate at RF ground potential.

### COLPITTS

#### Grounded Cathode

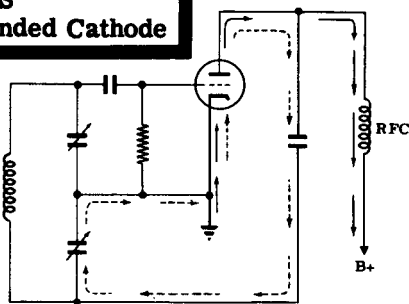

Legend  
— = DC  
- - - = RF

### COLPITTS

#### Grounded Plate

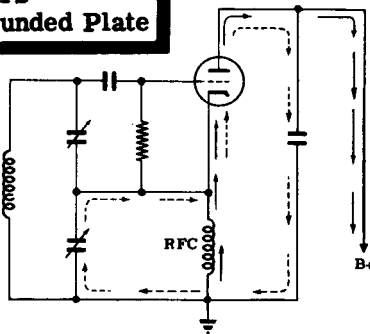

### COLPITTS

#### Grounded Grid

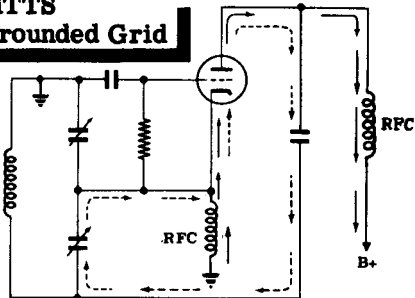

# MISCELLANEOUS OSCILLATORS

## Variations in Oscillators—Other Circuits

The oscillator circuits shown below are included so that you can become accustomed to analyzing many different forms of oscillators. They are all variations on the six basic oscillators which you studied in previous topics, except for the klystron oscillator, the principle of which is explained in the text.

### HARTLEY ECO

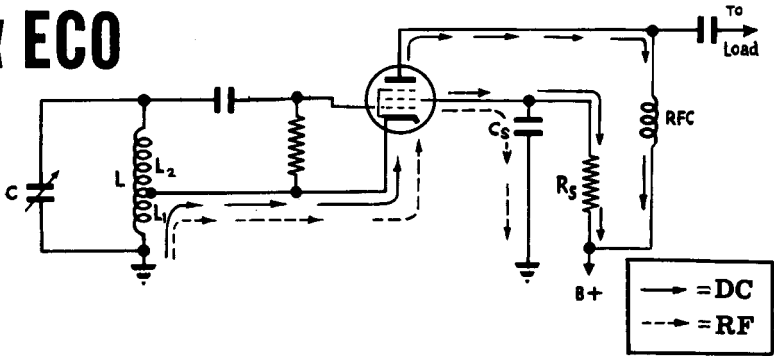

The most important thing to remember about oscillators, no matter what kind, is that they all must have certain features:

1. Something which couples the output to the input.
2. Something which corrects the phase of the voltage fed back.

Here are some other oscillator circuits. See if you can locate the source of feedback. Then trace the DC and RF paths.

### Armstrong ECO

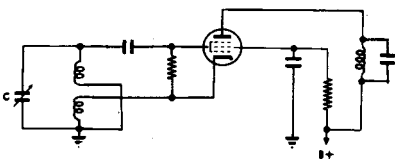

### Hartley Grounded Grid

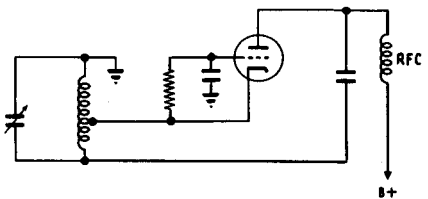

### Hartley Grounded Plate Series Feed

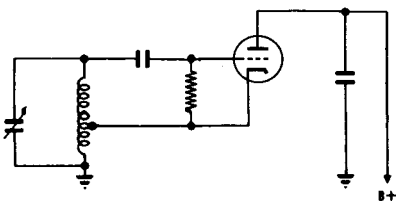

### Ultra-Audion Series Feed

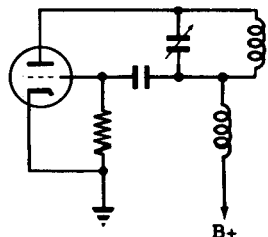

## MISCELLANEOUS OSCILLATORS

### High Frequency Oscillators

You have studied the basic oscillators used at low radio frequencies. These operate at high efficiency up to about 20 mc. Beyond 20 mc their efficiency drops unless specially designed high frequency tubes are used. Also the  $Q$  of the tuned circuits drops at high frequencies. This loss of efficiency becomes greater, until at 100 mc most tubes will lose fifty per cent of the power put into them. However, there are still tubes operating on the same principle as the ordinary 6C5 triode which can give reasonable efficiency up to around 700 mc. Beyond that—give up! Entirely different types of tubes and resonant circuits are needed to get more than 5 watts of RF power output. They operate on entirely different principles from those with which you are familiar.

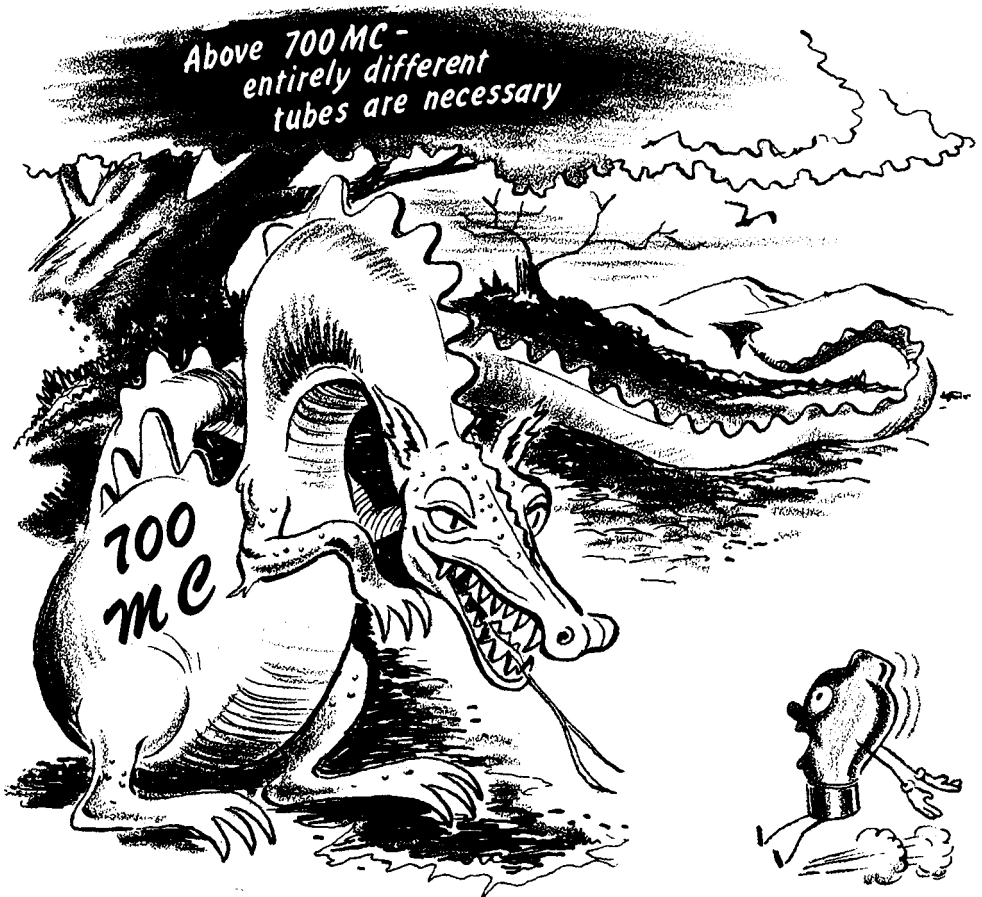

At very high frequencies the inductance of the connecting wires, and even of the tube leads, becomes greater than the inductance in the tuned circuit. Likewise, the grid-to-plate and grid-to-cathode capacity becomes greater than the capacity in the tuned circuit. The solution is to use shorter connecting leads and miniature tubes with low interelectrode capacity. Even then, these tiny tubes are useless at 1000 mc. Besides, small tubes cannot give much power output.



# MISCELLANEOUS OSCILLATORS

## Tuned Lines

At frequencies between 100 and 500 mc, it is still possible to get reasonable power from an oscillator using triodes with special tuned circuits. Instead of having coils with turns and capacitors with parallel plates, tuned lines, which are the equivalent of a coil and capacitor at low frequencies, are used.

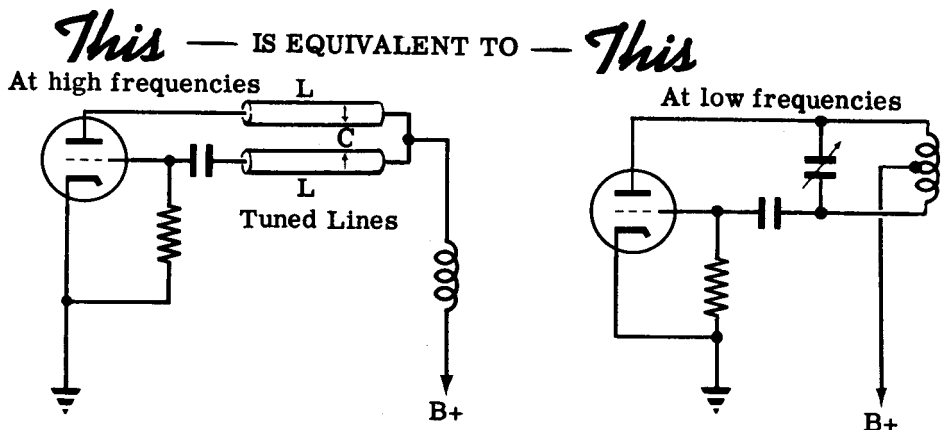

The characteristics of these tuned lines are calculated in the same way as characteristics of transmission lines, which you will find out about in "Transmitters." Inductance and capacitance of ordinary coils and capacitors is said to be "lumped." Inductance and capacitance of tuned lines is said to be "distributed." Here are some other high frequency oscillator circuits using distributed reactance (capacity and inductance).

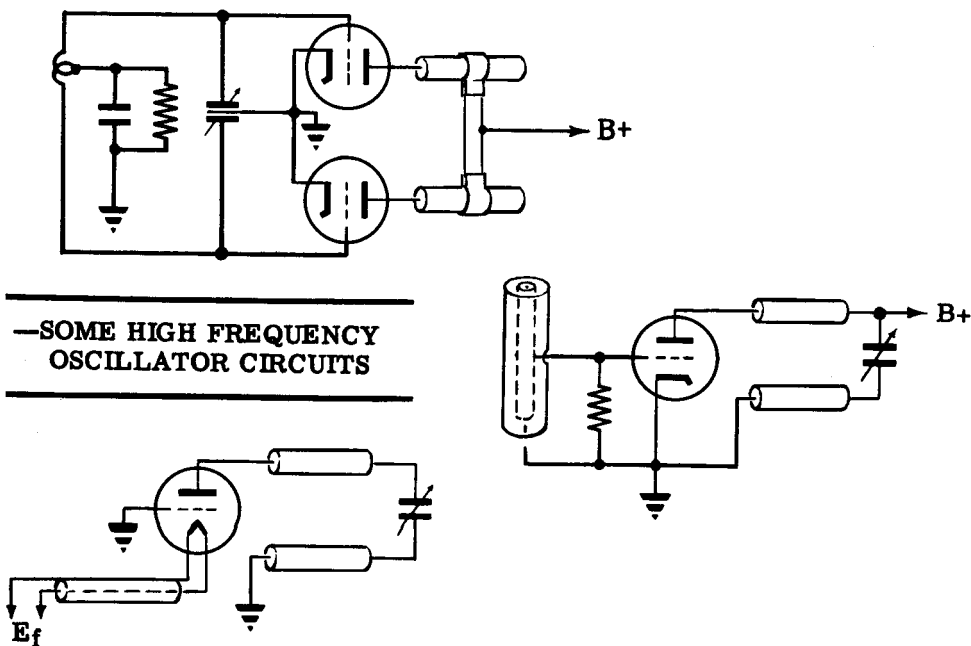

# MISCELLANEOUS OSCILLATORS

## Cavity Resonators at Ultra-high Frequencies

You have learned that the connecting leads between the tube and the tuned circuit have more reactance than the tuned circuit itself at high frequencies. One solution to this difficulty would be to eliminate the connecting leads by putting the tuned circuit inside the tube. What shape would the tuned circuit have then? Let's see.

Imagine yourself taking a low frequency tuned circuit and altering it for high frequencies. You would take turns off the coil. You would also make the tuning capacitor smaller. Eventually, the coil would be just a straight piece of wire. To lower the inductance still further, you would place another coil (straight piece of wire) in parallel with the first one. If you continued adding coils in parallel you would end up with a cavity resonator.



A TUNED  
CIRCUIT CHANGED TO -----

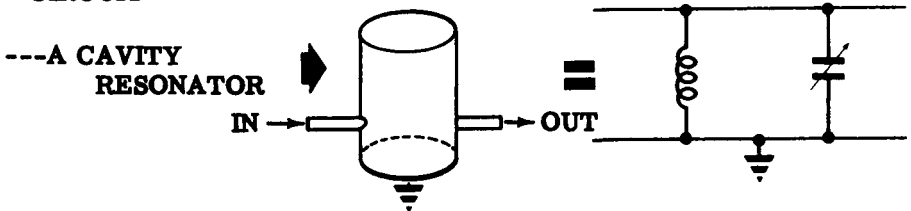

This cavity resonator is cylindrical in shape. If you performed the same conversion with a capacitor that has square plates, you would get a square cavity resonator. As a matter of fact almost any hollow metal structure can perform the job of a cavity resonator. Certain shapes are chosen because they are more convenient to work with. All cavity resonators have a very high  $Q$ , often 20 times higher than the best conventional tuned circuits. Remember that they do the same job as a conventional tuned circuit.

## OTHER TYPES OF CAVITY RESONATORS

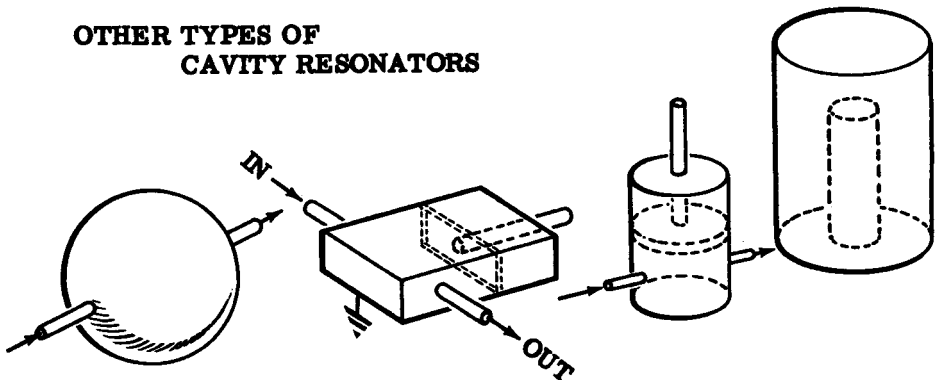

# MISCELLANEOUS OSCILLATORS

## The Klystron Tube

The klystron is a vacuum tube operating on an entirely different principle from conventional tubes. It can be made to amplify or oscillate. Its function as an oscillator is important at this point. Electrons leave the hot cathode and are accelerated by a positive grid. They fly toward a buncher, which is a pair of grids at the same positive potential as the accelerator. They reach the nearer of the two buncher grids first and deliver a kick to the tuned circuit, which starts it oscillating. By the time the first group of electrons reaches the second buncher grid, its potential has changed because of the oscillations in the tuned circuit. When the second buncher grid swings in a negative direction, fewer electrons get through. When it swings in a positive direction, more electrons get through. Although the electrons approach the buncher uniformly spaced, they leave the buncher in clusters. This is similar to the increase and decrease of plate current in a conventional oscillator.

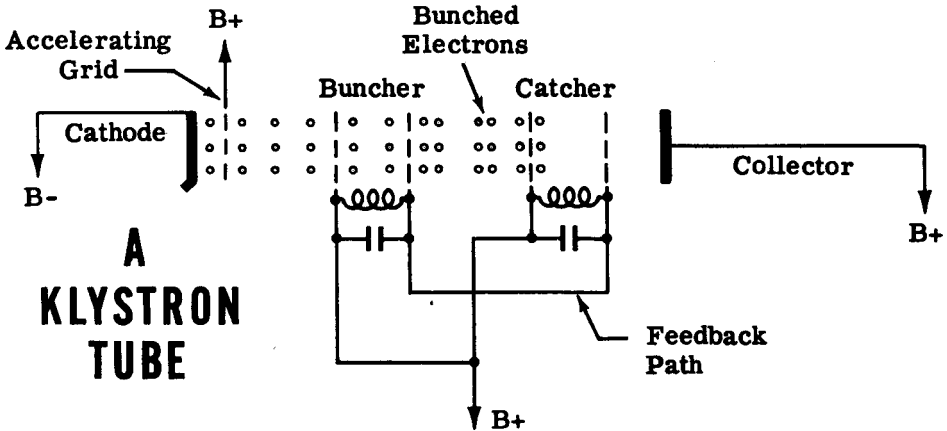

Then these bunched electrons reach the catcher grids and start the second tuned circuit oscillating. Since they keep arriving in bunches, they keep the second tuned circuit oscillating. The oscillations in the first tuned circuit will stop unless voltage is fed back from the catcher grids to keep it going. Of course the tuned circuits in the klystron are not coils and capacitors. They are cavity resonators.

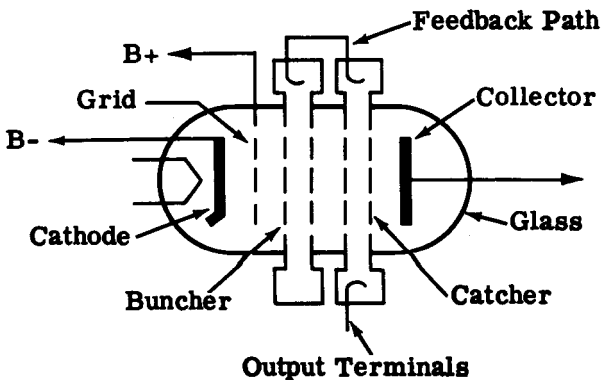

## SCHEMATIC OF KLYSTRON

# MISCELLANEOUS OSCILLATORS

## Review of High Frequency Oscillators

The description of the klystron tube was not included to make you into a klystron expert. There are other types of klystron tubes, and different circuits, too complex to be discussed at this point. The purpose of this description was to acquaint you with what sort of techniques are used at frequencies above the limit of conventional triodes. The klystron can operate efficiently above 10,000 mc. If you study radar you will learn about another ultra-high frequency oscillator, the magnetron. This tube can deliver millions of watts of RF power at 3000 mc and higher.

**SERIES FEED**—A circuit arrangement in which the plate current of the tube flows through the tank circuit. In cases where the plate of the tube goes directly to the tank, the entire B+ voltage is present at the tank. This presents the danger of shocks.

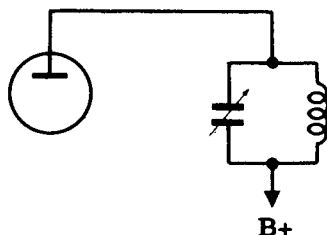

**SHUNT FEED**—A circuit arrangement in which the plate current of the tube flows through an RF choke and only RF voltage gets to the tank. This avoids the possibility of DC shock, but the RF choke cannot operate efficiently over a wide band of frequencies.

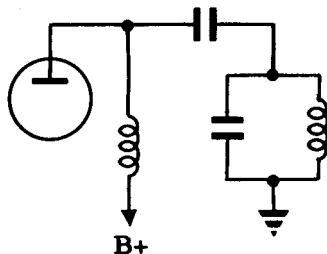

**GROUNDING POINTS**—Most oscillator circuits can be made to work with the plate, cathode or grid at RF ground potential.

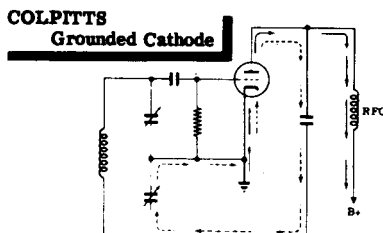
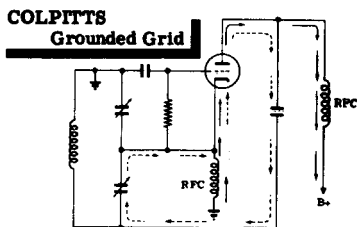
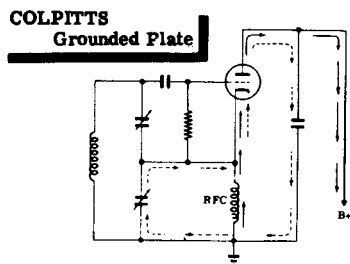

## MISCELLANEOUS OSCILLATORS

### Review of High Frequency Oscillators (continued)

**ECO**—The ECO is not a special type of oscillator. It is a circuit in which a screen-grid tube is used instead of a triode. The screen grid is the oscillator anode. It is at RF ground potential and therefore isolates the oscillator from the output circuit. Changes in loading have less effect on the frequency of oscillation.

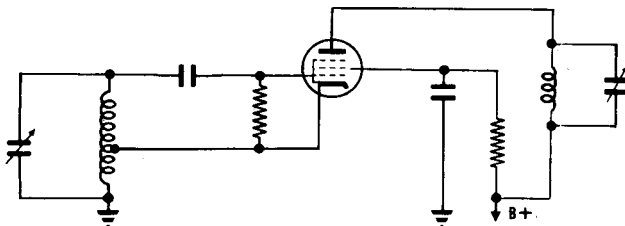

**LUMPED REACTANCE**—All standard coils and capacitors are lumped reactances.



**DISTRIBUTED REACTANCE**—Obtaining capacity or inductance from straight wires. Generally, parallel wires are used. At high frequencies, it becomes necessary to use distributed reactances because they have a higher Q than ordinary coils and capacitors.

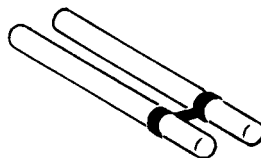

**CAVITY RESONATOR**—A hollow metal structure which exhibits the same characteristics at high frequencies as a coil and capacitor at low frequencies. It has a much higher Q than an ordinary coil and capacitor.

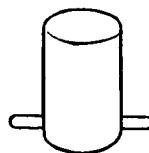

**KLYSTRON**—A vacuum tube designed to operate at frequencies above 1000 mc. It has several forms, all of which use a positive grid as an accelerator and other grids to bunch the electrons together in clusters.

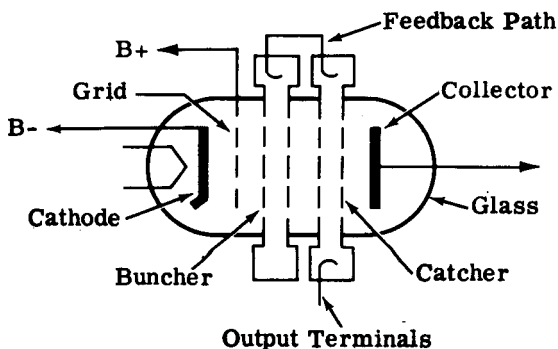

# OSCILLATORS

## Review of Oscillators

**ELECTRONIC OSCILLATOR**—A vacuum tube amplifier with a feedback circuit either internal or external to the tube. It generates continuous sine wave AC of a controllable frequency. It has a tuned circuit which does the oscillating and controls the frequency of the wave generated. The vacuum tube merely supplies pulses to keep the tuned circuit oscillating.

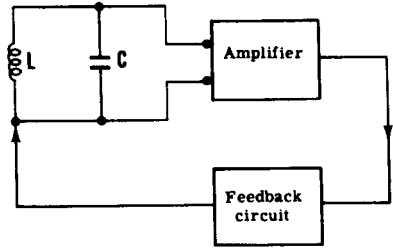

**ARMSTRONG OSCILLATOR**—uses a tickler coil to feed back pulses from the plate circuit to the tank circuit.

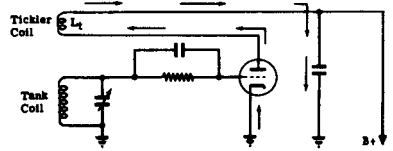

**HARTLEY OSCILLATOR**—uses a tapped coil instead of a separate tickler winding to feed back pulses. It has more frequency stability than the Armstrong.

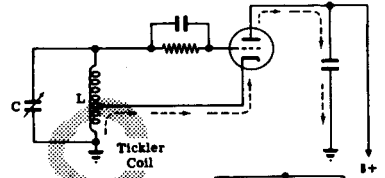

**COLPITTS OSCILLATOR**—uses a tapped capacitance network to couple the pulses to the tank. It has more frequency stability than the Hartley.

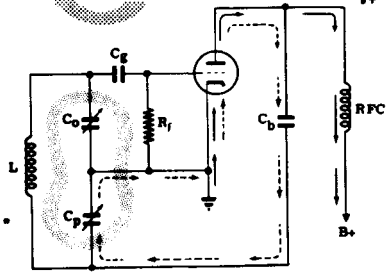

**TPTG OSCILLATOR**—uses the grid-plate capacitance of a triode to feed back pulses to a tuned circuit connected to the grid. It oscillates only when the two tuned circuits are set to or near the same frequency.

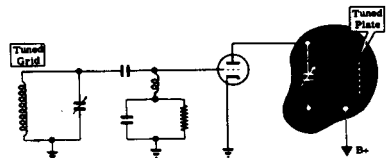

**CRYSTAL OSCILLATOR**—is like a TPTG oscillator, but a crystal is connected in place of the grid tank circuit. It can only oscillate at, or very close to, the frequency of the crystal. It has more frequency stability than any other oscillator.

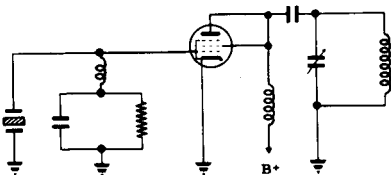

# OSCILLATORS

## Review of Oscillators (continued)

**ELECTRON-COUPLING**—is a method of connecting other oscillator circuits. In the electron-coupled oscillator, the screen grid is the feedback electrode, leaving the plate independent of the oscillator section. Changes in load and plate voltage have little effect on oscillator frequency. It is more stable than any other oscillator except the crystal.

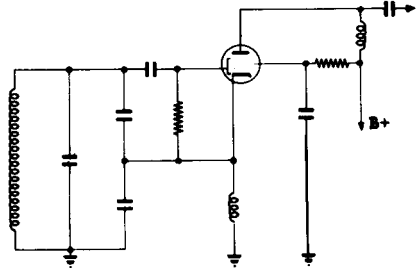

**SERIES FEED**—a circuit arrangement in which the plate current of the tube flows through the tank circuit. In cases where the plate of the tube goes directly to the tank, the entire B+ voltage is present at the tank. This presents the danger of shocks.

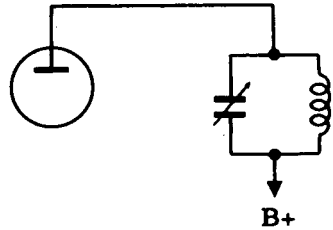

**SHUNT FEED**—a circuit arrangement in which the plate current of the tube flows through an RF choke, and only RF voltage gets to the tank. This avoids the possibility of DC shock, but the RF choke cannot operate efficiently over a wide band of frequencies.

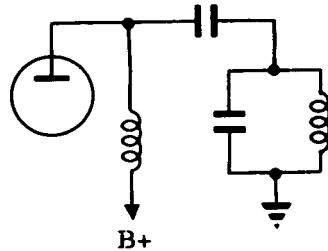

**FREQUENCY STABILITY**—the ability of an oscillator to keep putting out the same frequency when it is subjected to changes in load and plate voltage, heat, humidity, vibration, etc.

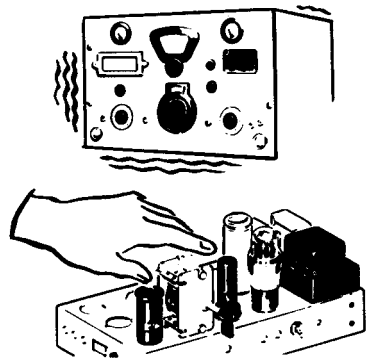

## INDEX TO VOL. 3

(Note: A cumulative index covering all five volumes in this series will be found at the end of Volume 5.)

- Amplifiers, amplification in, 3-15
- Armstrong, oscillators, 3-55 to 3-61
  - advantages of grid leak bias in, 3-60
  - frequency stability in, 3-61
  - grid leak bias in, 3-56
  - how oscillations are maintained in, 3-57, 3-58
- Bandpass, 3-37
- Capacitors, how they are connected to RF amplifier tube, 3-30
  - tuning, 3-25
- Coils, how they are connected to RF amplifier tube, 3-30
  - tuning, 3-26
- Colpitts oscillators, 3-64
- Compensating networks, high-frequency compensation, 3-5
  - low-frequency compensation, 3-6
- Crystals, as resonators, 3-69
- Crystal oscillators, 3-68 to 3-73
  - analysis of, 3-72
  - introduction to, 3-68
  - tuning in, 3-71
- Crystal oscillator circuits, 3-70
- Degeneration, 3-7 to 3-9
- Electron-coupled oscillators, 3-74 to 3-77
  - analysis of, 3-77
  - introduction to, 3-74
- Electron-coupled oscillator circuits, 3-75, 3-76
- Frequency response, improving, 3-7 to 3-9
- Hartley oscillators, 3-62, 3-63
  - how oscillations are maintained, 3-63
- High frequency oscillators, 3-82
  - tuned lines in, 3-83
- Klystron tubes, 3-85
- LC circuits, parallel, 3-21, 3-22
  - series, 3-20
- Oscillators, 3-41 to 3-89
  - different grounding points in, 3-80
  - electronic, 3-48 to 3-52
  - feedback circuits in, 3-53
  - frequency stability of, 3-54
  - introduction to, 3-43 to 3-54
  - other circuits, 3-81
  - RF ground potential, 3-79
  - series feed, 3-78
  - shunt feed, 3-78
  - what they do, 3-44
  - why they are studied, 3-43
- Oscillations, frequency of, 3-59
  - what they are, 3-45 to 3-47
- Pentodes, remote cut-off, 3-32, 3-33
  - why they are used in RF amplifiers, 3-28, 3-29
- Resonators, cavity type at ultra-high frequencies, 3-84
- Resonant circuits, how stations are selected, 3-23
- Review, A Single-Stage RF Amplifier, 3-34
  - Miscellaneous Oscillators, 3-86, 3-87
  - Oscillators, 3-88, 3-89
  - The Armstrong and Hartley Oscillators, 3-65
  - The Tuned-Plate Tuned-Grid and Crystal Oscillators, 3-73
  - The Two-Stage RF Amplifier, 3-39
  - Tuned Circuits, 3-27
  - Video Amplifiers, 3-10, 3-11
- RF amplifiers, 3-13 to 3-39
  - introduction to, 3-15 to 3-18
  - two-stage, 3-35 to 3-39
  - single-stage, 3-28 to 3-34
  - what it does, 3-16, 3-17
- RF amplifier circuit, development of, 3-31
- RF stages, how they are coupled, 3-38
  - why more than one is used, 3-35, 3-36
- Selectivity, 3-37
  - and "Q", 3-24
- Square waves, distortion of, 3-3, 3-4
- Tuned circuits, what they are, 3-19
- Tuned-plate tuned-grid oscillators, 3-66, 3-67
  - feedback in, 3-67
  - introduction to, 3-66
- Video amplifiers, 3-1 to 3-11
  - introduction to, 3-1, 3-2



## HOW THIS OUTSTANDING COURSE WAS DEVELOPED:

In the Spring of 1951, the Chief of Naval Personnel, seeking a streamlined, more efficient method of presenting Basic Electricity and Basic Electronics to the thousands of students in Navy speciality schools, called on the graphiological engineering firm of Van Valkenburgh, Nooger & Neville, Inc., to prepare such a course. This organization, specialists in the production of complete "packaged training programs," had broad experience serving industrial organizations requiring mass-training techniques.

These were the aims of the proposed project, which came to be known as the Common-Core program: to make Basic Electricity and Basic Electronics completely understandable to every Navy student, regardless of previous education; to enable the Navy to turn out trained technicians at a faster rate (cutting the *cost* of training as well as the time required) without sacrificing subject matter.

The firm met with electronics experts, educators, officers-in-charge of various Navy schools and, with the Chief of Naval Personnel, created a dynamic new training course . . . completely up-to-date . . . with heavy emphasis on the visual approach.

First established in selected Navy schools in April, 1953, the training course comprising Basic Electricity and Basic Electronics was such a tremendous success that it is now the *backbone* of the Navy's *current* electricity and electronics training program!\*

The course presents one fundamental topic at a time, taken up in the order of need, rendered absolutely understandable, and hammered home by the use of clear, cartoon-type illustrations. These illustrations are the most effective ever presented. *Every page has at least one such illustration—every page covers one complete idea!* An imaginary instructor stands figuratively at the reader's elbow, doing demonstrations that make it easier to understand each subject presented in the course.

Now, for the first time, Basic Electricity and Basic Electronics have been released by the Navy for civilian use. While the course was *originally* designed for the Navy, the concepts are so broad, the presentation so clear—*without* reference to specific Navy equipment—that it is ideal for use by schools, industrial training programs, or home study. *There is no finer training material!*

"Basic Electronics" consists of *five* volumes, as follows: *Vol. 1—Introduction to Electronics, Diode Vacuum Tubes, Dry Metal Rectifiers, What a Power Supply Is, Filters, Voltage Regulators. Vol. 2—Introduction to Amplifiers, The Triode Tube, Tetrodes & Pentodes, Audio Voltage & Power Amplifiers. Vol. 3—Video Amplifiers, RF Amplifiers, Oscillators. Vol. 4—Transmitters, Transmission Lines & Antennas, CW Transmission & Amplitude Modulation. Vol. 5—Receiver Antennas, Detectors & Mixers, TRF Receivers, Superheterodyne Receivers.*

\*"Basic Electricity," the first portion of this course, is available as a separate series of volumes.

**JOHN F. RIDER PUBLISHER, INC., 116 WEST 14th ST., N. Y. 11, N. Y.**



No. 170-4

# basic electronics

by **VAN VALKENBURGH,  
NOOGER & NEVILLE, INC.**

**VOL. 4**

TRANSMITTERS  
TRANSMISSION LINES &  
ANTENNAS  
CW TRANSMISSION &  
AMPLITUDE MODULATION

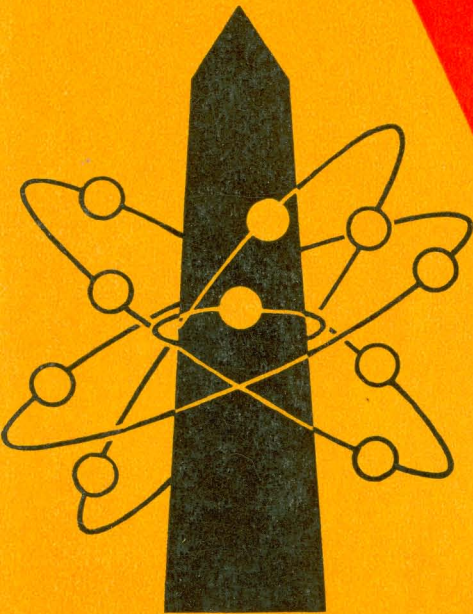

A. STICH

a **RIDER** publication

\$2.25

# **basic electronics**

**by VAN VALKENBURGH,  
NOOGER & NEVILLE, INC.**

**VOL. 4**



**JOHN F. RIDER PUBLISHER, INC.**  
116 West 14th Street • New York 11, N. Y.

**First Edition**

*Copyright 1955 by*

**VAN VALKENBURGH, NOOGER AND NEVILLE, INC.**

**All Rights Reserved under International and Pan American Conventions. This book or parts thereof may not be reproduced in any form or in any language without permission of the copyright owner.**

*Library of Congress Catalog Card No. 55-6984*

**Printed in the United States of America**

## PREFACE

The texts of the entire Basic Electricity and Basic Electronics courses, as currently taught at Navy specialty schools, have now been released by the Navy for civilian use. This educational program has been an unqualified success. Since April, 1953, when it was first installed, over 25,000 Navy trainees have benefited by this instruction and the results have been outstanding.

The unique simplification of an ordinarily complex subject, the exceptional clarity of illustrations and text, and the plan of presenting one basic concept at a time, without involving complicated mathematics, all combine in making this course a better and quicker way to teach and learn basic electricity and electronics.

In releasing this material to the general public, the Navy hopes to provide the means for creating a nation-wide pool of pre-trained technicians, upon whom the Armed Forces could call in time of national emergency, without the need for precious weeks and months of schooling.

Perhaps of greater importance is the Navy's hope that through the release of this course, a direct contribution will be made toward increasing the technical knowledge of men and women throughout the country, as a step in making and keeping America strong.

*Van Valkenburgh, Nooger and Neville, Inc.*

*New York, N. Y.*

*February, 1955*

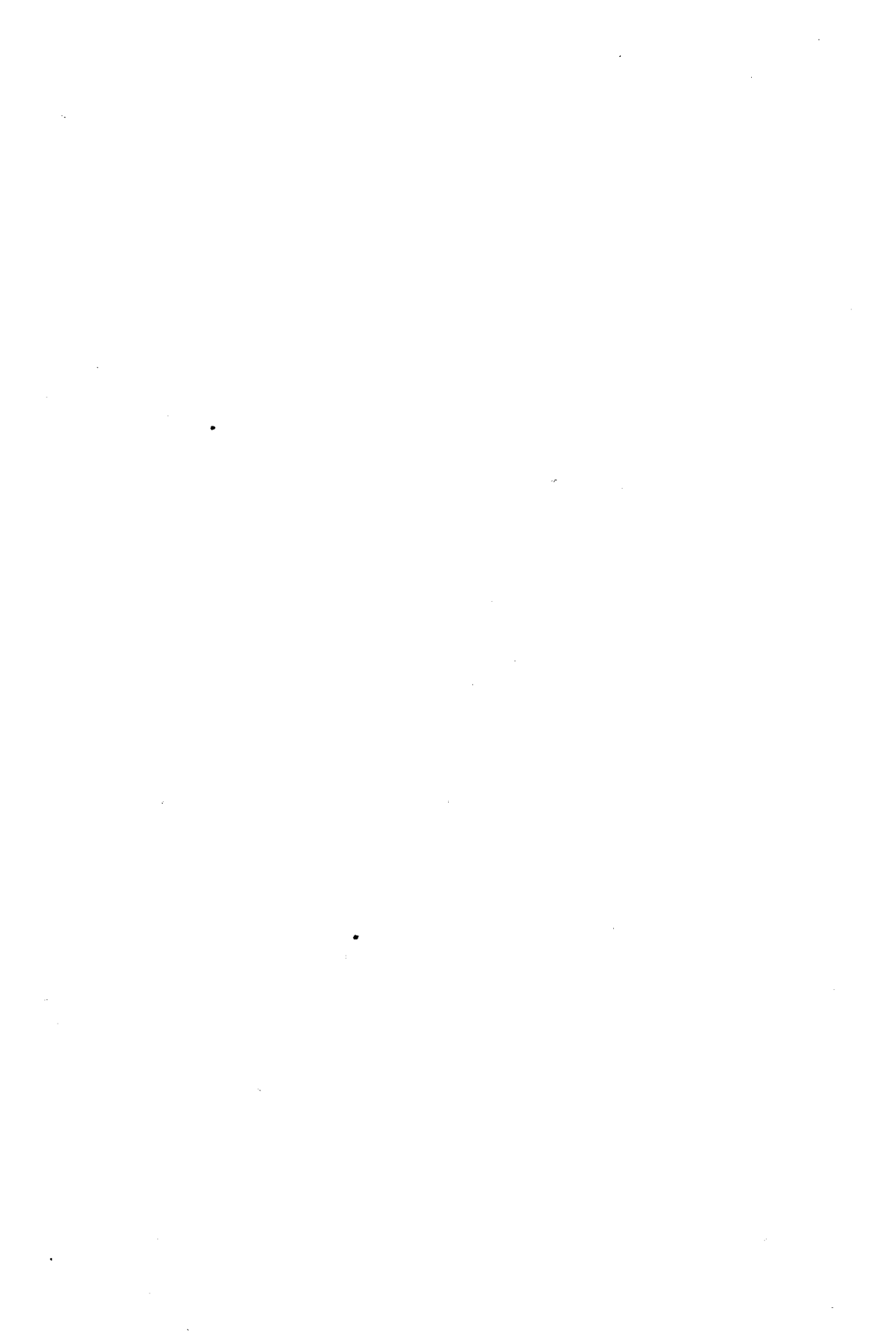

# TABLE OF CONTENTS

## VOL. 4 — BASIC ELECTRONICS

What a Transmitter Is . . . . .	4-1
Class C Amplifiers . . . . .	4-8
A Three Stage Transmitter . . . . .	4-16
Frequency Multipliers . . . . .	4-34
Transmission Lines . . . . .	4-39
Antennas . . . . .	4-63
CW Transmission . . . . .	4-80
Amplitude Modulation . . . . .	4-85





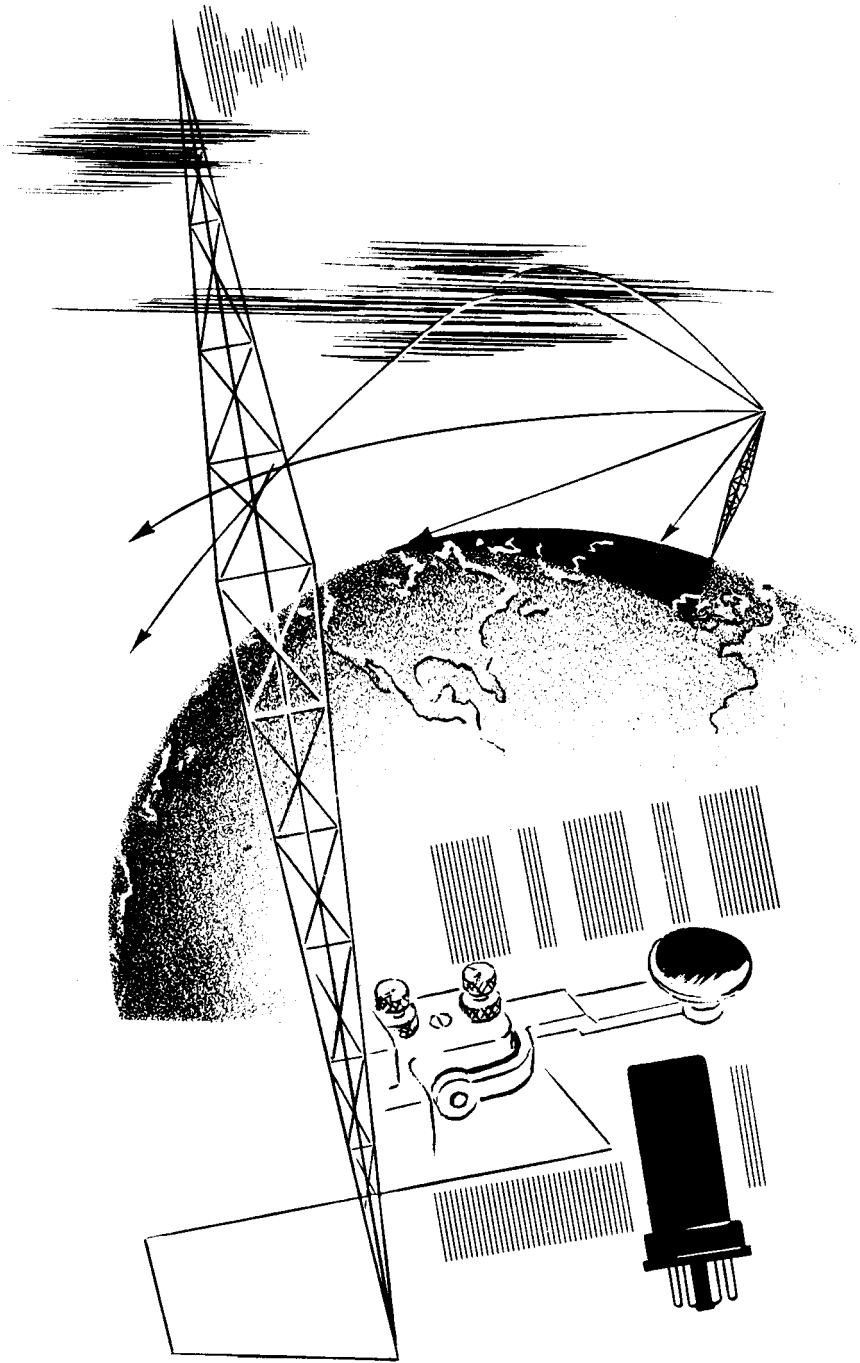

*Transmitters*



## WHAT A TRANSMITTER IS

### What You Know About Transmitters

Probably very few of you have had any direct experience with transmitters. To many of you, the word itself may be unfamiliar. However, you have referred many times to one type of transmitter—a radio station.

When you listen to a radio, the sounds you hear travel to the radio receiver through the air. If someone were to ask you how those "sounds" happened to be in the air, you would probably say, "A radio station broadcasts them."

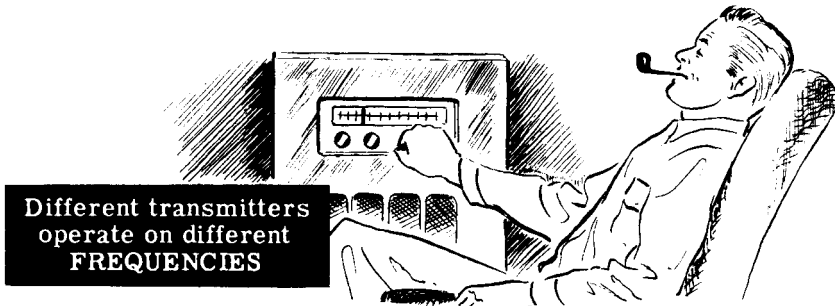

There are other things you already know about transmitters from your experience with radio sets. You know that "changing stations" is also called "tuning." From this, you realize that different transmitters operate at different frequencies. You select the station you want to listen to by tuning your radio to the frequency of that station.

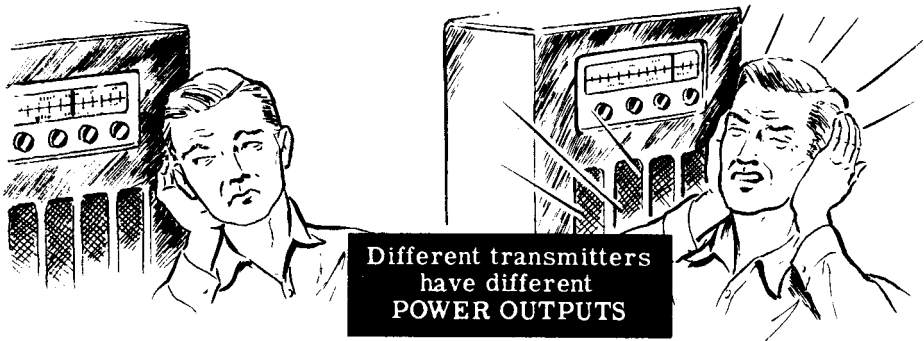

You have also noticed that some stations come in stronger than others. If different transmitters at equal distances away have different power outputs, the station whose transmitter has the largest power output will be heard the loudest. Also, if there are two stations whose transmitters have the same power output, you will hear more loudly the station that is closer to your radio set.

You see that you really knew some things about transmitters even if you never heard the word before.

# WHAT A TRANSMITTER IS

## A Simple Transmitter

The simplest transmitter consists of an oscillator which generates a high frequency signal. The oscillator—and the type of oscillator doesn't matter—could be connected to an antenna to make up a complete transmitter. The antenna in this case would radiate a signal which is constant in amplitude and of the same frequency as the oscillator.

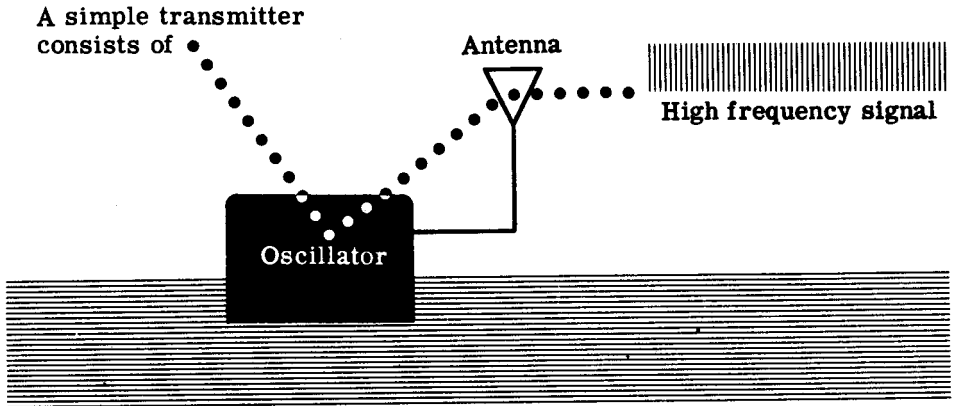

If your home radio set picked up the constant-amplitude signal from such a transmitter, you would hear nothing at all. If a special type of radio received this signal, a constant audio tone would be heard. In either of these cases, no message could be "read" from the incoming signal—such a signal is said to contain "no intelligence." To add intelligence to the signal, the oscillator would be turned on and off with a key to produce dots and dashes.

### Putting the transmitter to work . . . . .

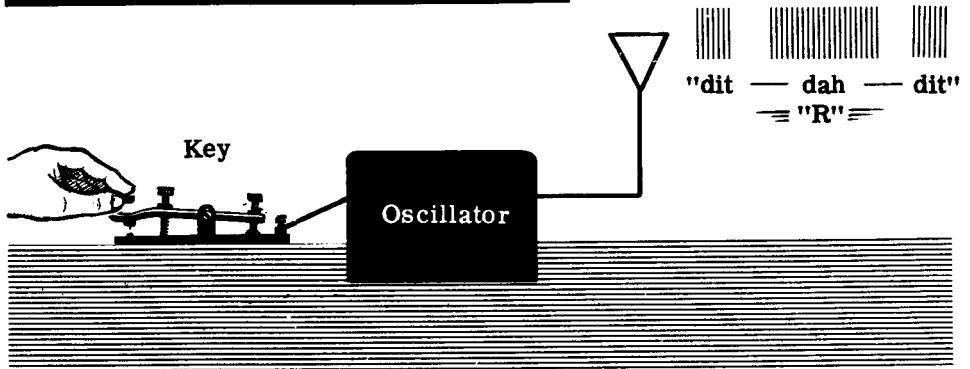

A signal of this type contains intelligence since a message can be obtained from it. The radio would produce a sound somewhat like "dit-dah-dit" which a radio operator understands as the letter "R."

## WHAT A TRANSMITTER IS

### A Simple Transmitter (continued)

Almost every transmitter contains more than just an oscillator. There are two main drawbacks to connecting the oscillator directly to the antenna. The first is that the power output would be limited because there are no stages of RF amplification between the oscillator and the antenna to build up the strength of the RF signal. Power output is important because it determines the distance over which the transmitted signal can be picked up by the receiver.

The other consideration is frequency stability. An oscillator from which a large amount of power is drawn has a tendency to drift in frequency. A drift in the frequency of the transmitted signal would mean that a portion of the message would be lost by the operator trying to receive it.

For these reasons—poor frequency stability and low power output—oscillators are not connected directly to an antenna.

## *Frequency Drift and Low Power Output*

*result in poor reception....*

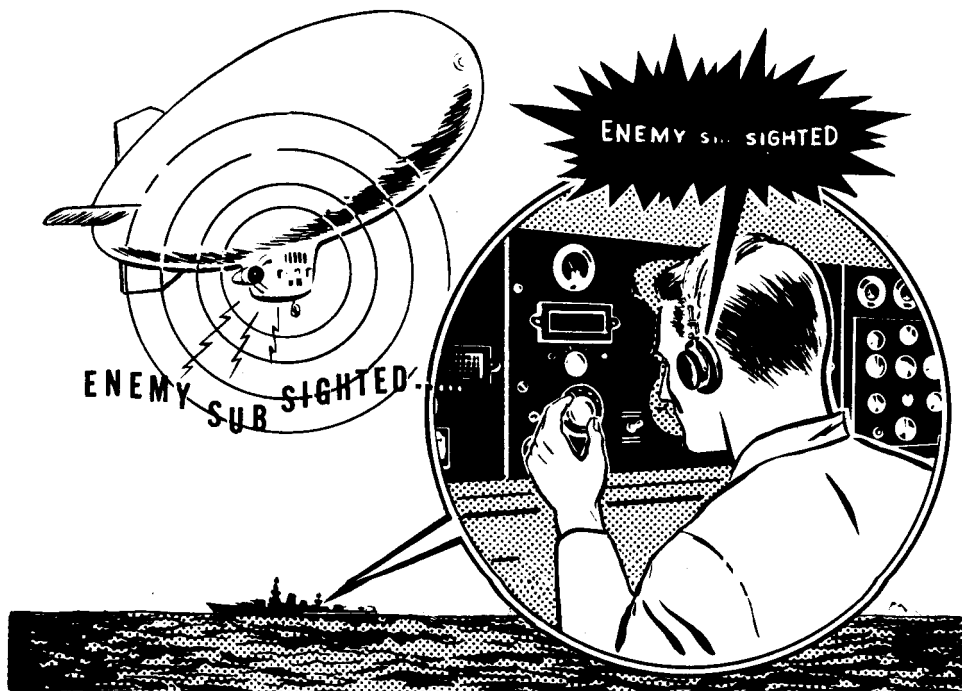

## WHAT A TRANSMITTER IS

### A Simple Transmitter (continued)

To overcome the limitations of connecting an oscillator directly to the transmitting antenna, one or more stages of amplification are connected between the oscillator and the antenna. The stage which is connected to the antenna is usually called the "final power amplifier." The other stages of amplification are known by several names. Sometimes they are referred to as the "first and second power amplifiers," and sometimes as "intermediate power amplifiers." In addition, the first power amplifier, since it serves to isolate the oscillator from variations of load, is also called a "buffer" amplifier.

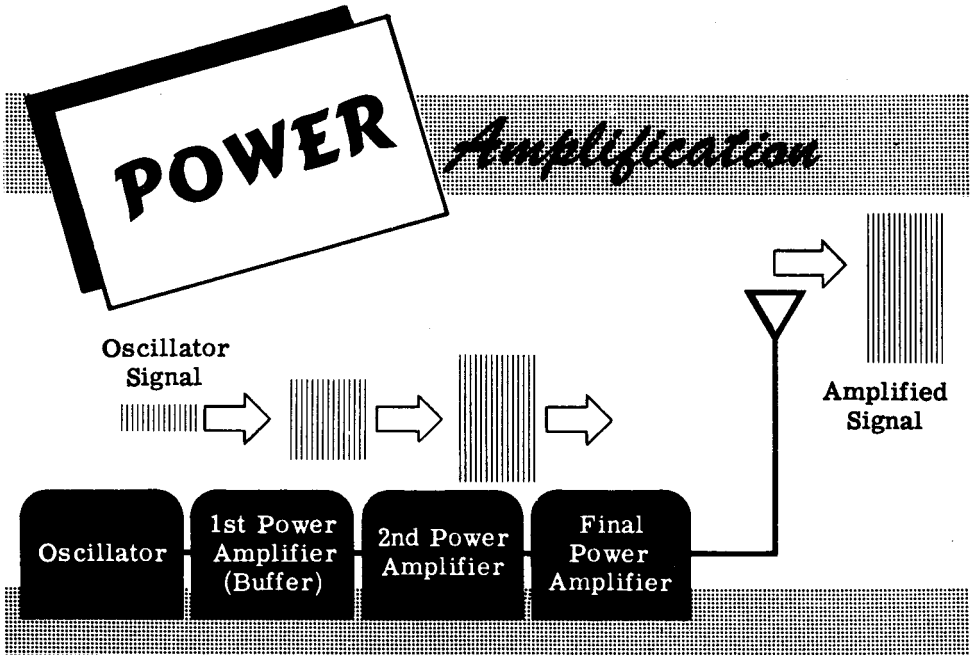

The RF signal is generated in the oscillator circuit and is amplified by the first and second power amplifiers which drive the final power amplifier. The powerful signal from the final power amplifier is fed to the antenna which radiates the signal into space.

As has been said, the RF signal by itself does not contain any intelligence. However, several things may be done to it so that it will contain or carry a message. Because of this, the RF signal is commonly referred to as "the carrier wave"—it is not, of itself, the message, but it can carry a message to some distant point.

# WHAT A TRANSMITTER IS

## Keyed Transmission

A transmitted signal may contain a message in several forms such as code or voice. The process by which the carrier wave is changed so that it can carry a message is called "modulation." Every communication transmitter needs modulation because the carrier by itself (unmodulated) cannot be interpreted as having any meaning.

In most transmitters the message is transmitted either in code or by voice. The most common types of code transmission are continuous wave (CW) and modulated continuous wave (MCW). In CW transmission the RF to the antenna is interrupted or turned on and off with a hand key so that the carrier is radiated as dots and dashes. CW is used primarily for long distance communication. A special receiver is needed to receive CW.

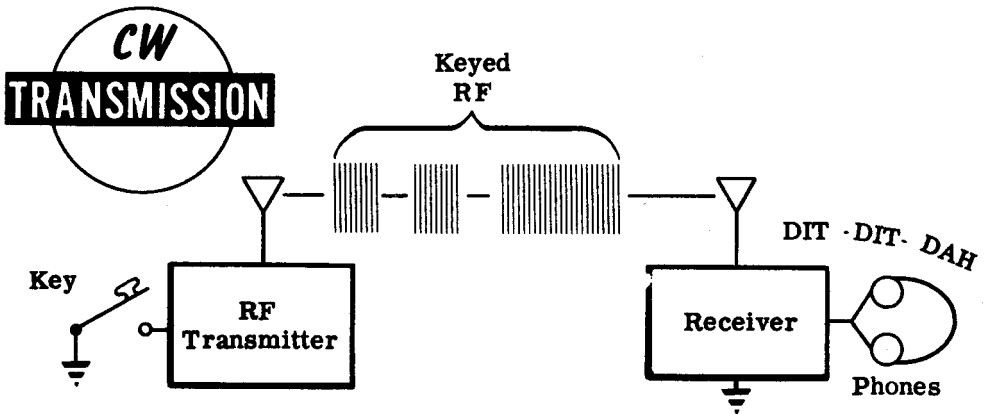

In MCW transmission a constant amplitude audio frequency is superimposed on the carrier. The carrier is then turned on and off with a key just as in CW transmission. Any receiver with the proper frequency range can receive MCW. MCW transmission is used mostly for emergency communication.

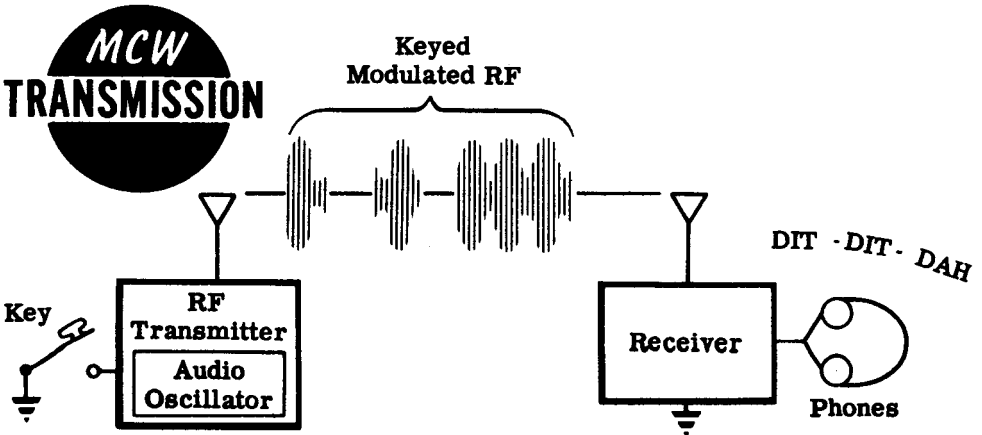

## WHAT A TRANSMITTER IS

### Voice Transmission

Voice transmission is also of two types. In the most common type of voice transmission used the amplitude of the carrier is varied in the same manner as the amplitude of the voice signal. This is called "amplitude modulation" (AM) and is the type of transmission used in the standard radio broadcast.

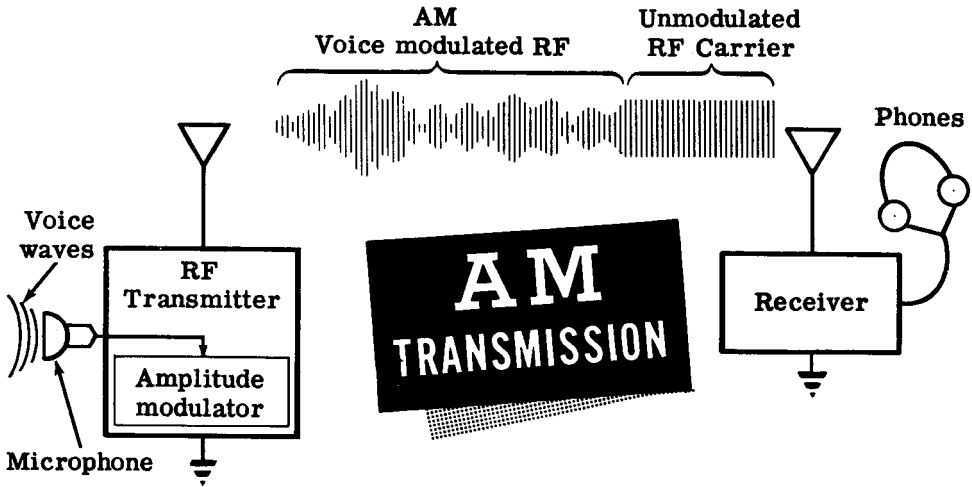

The other type of voice transmission, which is being used more and more, is called "frequency modulation" (FM). Here the frequency of the carrier is shifted back and forth at a rate equal to the frequency of the voice signal. FM transmission is comparatively free from "static" interference, is used in place of AM when the latter may be difficult to receive.

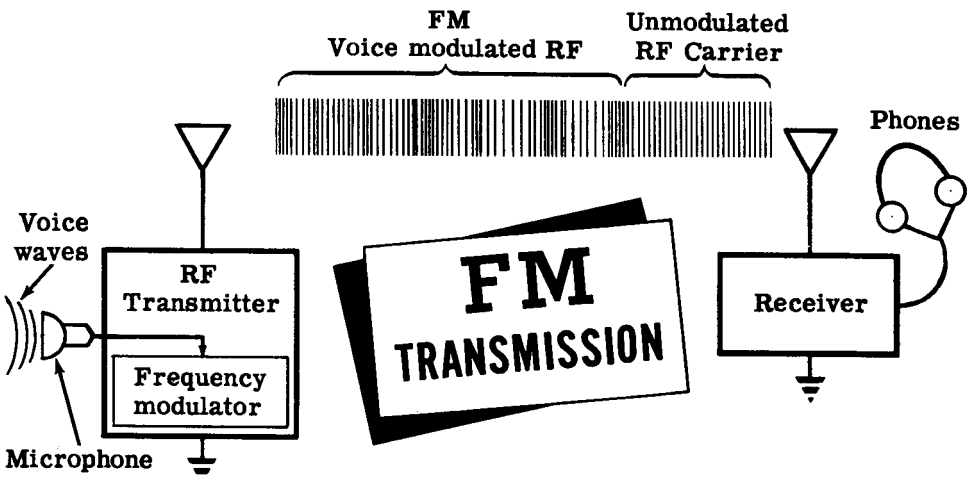



## WHAT A TRANSMITTER IS

### What You Will Learn About Transmitters

At this point in your study of electronics, you could not go up to a transmitter front panel and use it efficiently. However, after you have gone through this section the terminology and also the function of the various controls and indicators will be clear to you.

In order to understand the various transmitters found in equipment, whether in sonar, radar, communications equipment, etc., you first will need to understand how basic transmitter circuits operate. The three-stage RF transmitter you will learn about in this section is the key to understanding other transmitter circuits you will work with. When you know what each circuit in this basic transmitter does and how it should operate correctly, you will have the foundation to work with nearly any type transmitter in whatever equipment it may be found.

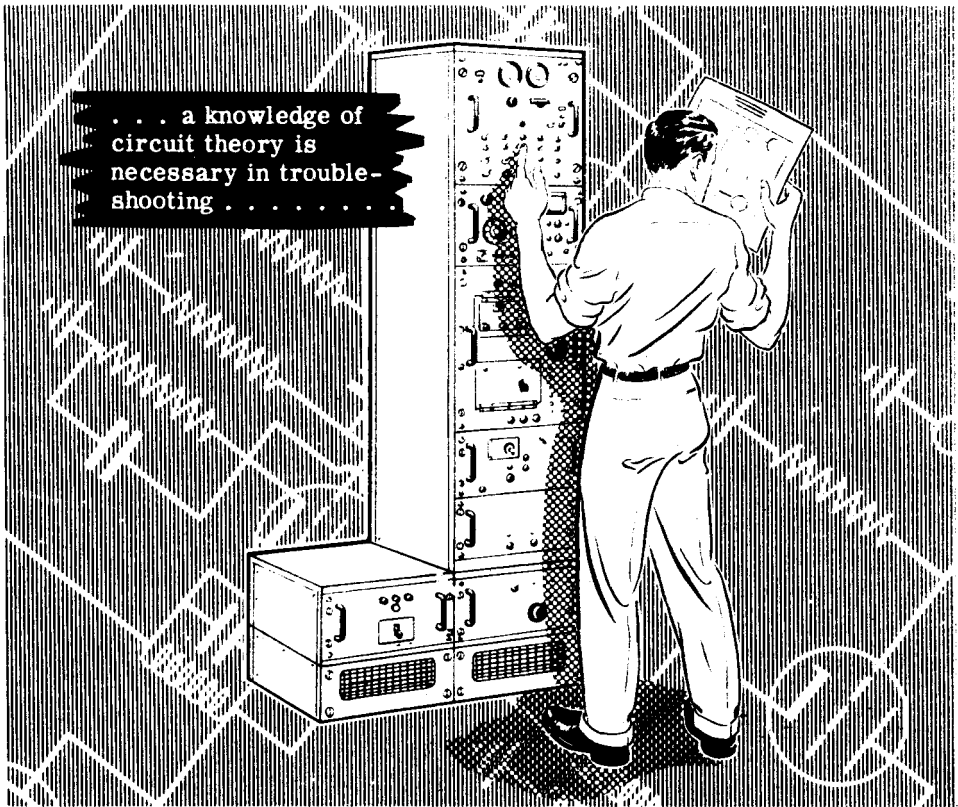

The type of amplifier most commonly used in transmitter circuits is the tuned Class "C" power amplifier. You will study the operation of this circuit first. Then you will see how Class "C" amplifiers are used in a typical three-stage transmitter. From here you will go into a study of transmission lines, antennas and coupling circuits which together help to get the signal into the air.

## CLASS C AMPLIFIERS

### Review of Classes of Operation

You remember from your study of amplifiers that there are three main types of vacuum tube operation—Class A, Class B, and Class C.

In Class A operation, the grid is biased near the midpoint of the linear portion of the plate current – grid voltage curve. The AC signal on the grid causes the grid voltage to vary above and below the bias value. The current variations are proportional to the grid voltage since the grid voltage swing does not go beyond the linear portion of the curve. Plate current flows throughout the entire AC cycle since the grid voltage does not bring the tube into cut-off.

In Class B operation, the grid is biased at or near its cut-off value. The AC signal drives the tube into cut-off for approximately half of the cycle. Thus the tube conducts for about 180 degrees of the cycle and is cut off during the other 180 degrees of the cycle.

In Class C operation—the type of operation with which you will be most concerned in your study of transmitters—the grid is biased considerably beyond cut-off. The tube remains cut off for most of each AC cycle and current flows in the tube only when the AC signal increases the grid voltage above cut-off. The plate current therefore flows in pulses as shown.

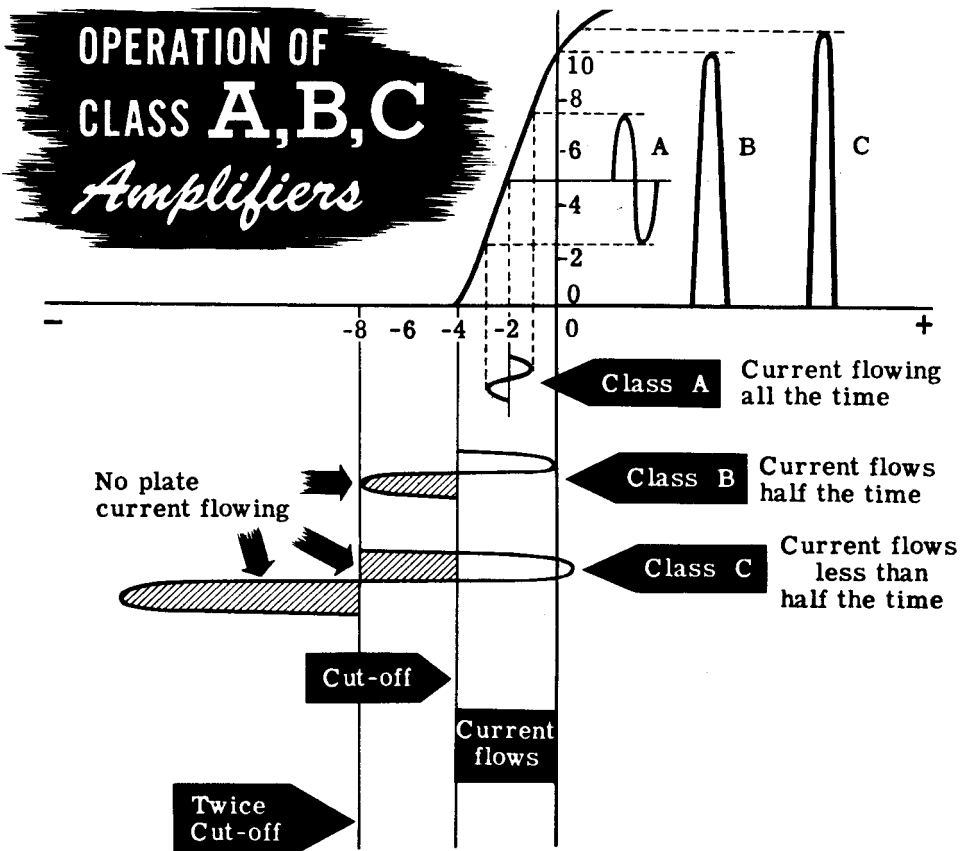

# CLASS C AMPLIFIERS

## Tuned Class C Amplifiers

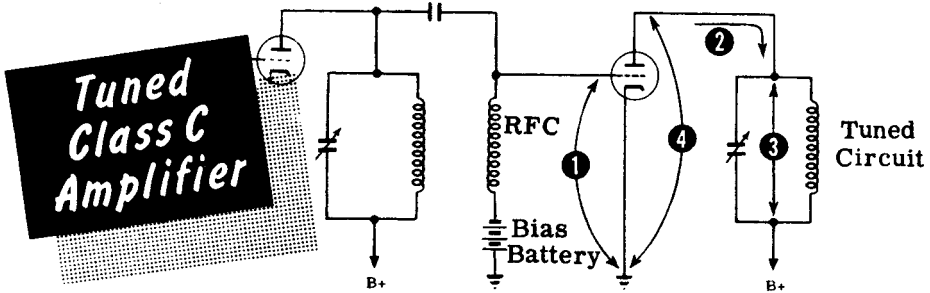

The operation of a Class C amplifier will become clear when you analyze what happens in a tuned amplifier such as the one shown in the schematic diagram. An AC signal is developed across the tuned circuit in the plate of the previous stage. This voltage also appears across the RF choke (RFC) in the grid circuit of the tuned Class C amplifier stage. The DC bias provided by the bias battery causes the tube to operate Class C.

The pulses of tube current which flow as a result of this type of operation deliver a "kick" to the tuned circuit in the plate. This "kick" makes the tuned circuit oscillate, and it fills in the part of the cycle during which plate current has stopped. For a review of how oscillations are kept going in a tuned circuit, refer to the section on oscillators, Volume 3.

The plate voltage is the difference between the B+ voltage and the AC voltage across the tuned circuit. When the pulse of plate current flows, the voltage at the plate end of the tuned circuit goes negative and subtracts from the B+ voltage. When the voltage across the tuned circuit reverses and goes positive at the plate end, it adds to the B+ voltage. As a result, the plate voltage wave form varies above and below the B+ voltage level as shown.

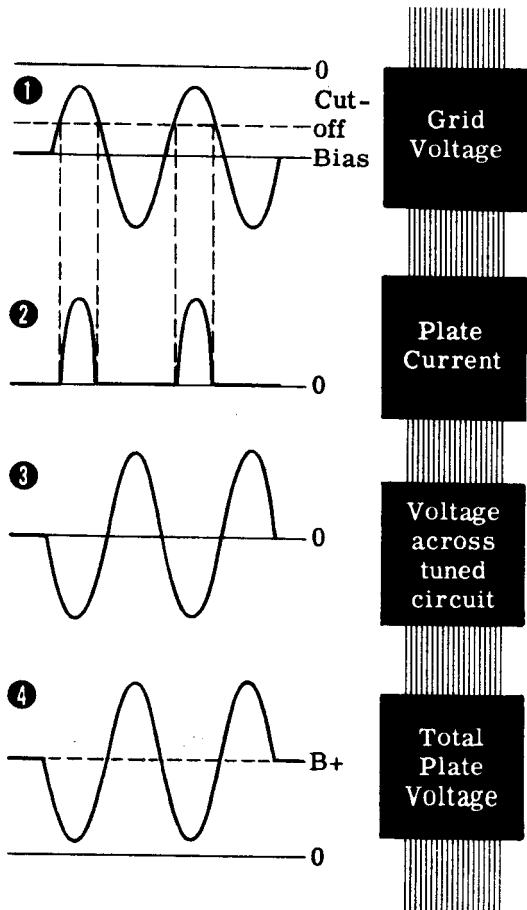

## CLASS C AMPLIFIERS

### Tuned Class C Amplifiers (continued)

The reason why tuned Class C amplifiers are universally used in high powered transmitters is because of their high efficiency of operation which results in a maximum of radiated power.

The power we supply to an amplifier is always greater than the power we get out of it. Some power is used up by the tube and the rest appears as useful output in the load. The power used up by the tube equals its plate voltage times its plate current.

Since the plate current of a Class C amplifier flows during less than half the cycle, the average plate current is less than in Class A or B operation. Therefore less power is used up by the tube and more power can get to the output. This makes the Class C amplifier more efficient and therefore more desirable for use in a transmitter.

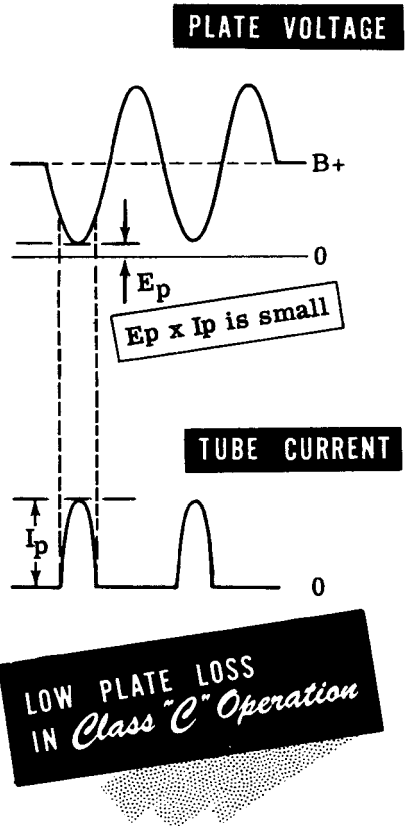

If the tuned circuit in the plate is not tuned to the frequency of the input signal, then the voltage across it will be lower—in proportion to how much it is mistuned. The further off it is tuned, the less power will appear across it and the more power will be dissipated by the tube itself. Then the efficiency of the amplifier is lower, the tube heats up more, and the power output is lower.

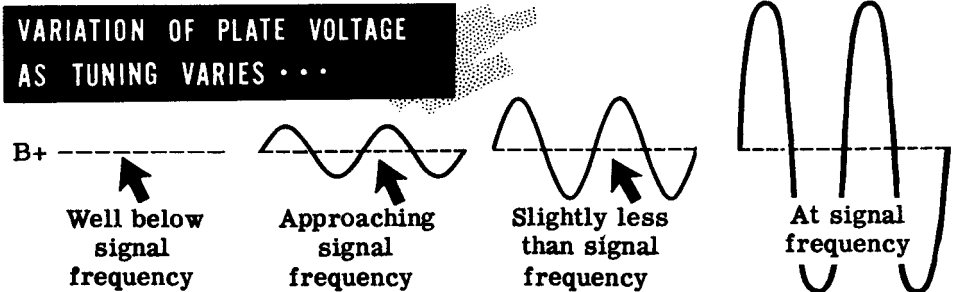

## CLASS C AMPLIFIERS

### Fixed Bias

The term "fixed bias" describes any method of obtaining bias in which the bias remains fixed as the strength of the input signal varies.

Fixed bias may be obtained from a negative power supply, from a motor-generator set, with a negative DC output, or from a battery. Each of these methods will keep the grid at a constant negative DC voltage which will not vary regardless of the strength of the signal input. The fixed negative bias is called "C-" just as the positive supply voltage is called "B+."

## Fixed Bias may be obtained from...

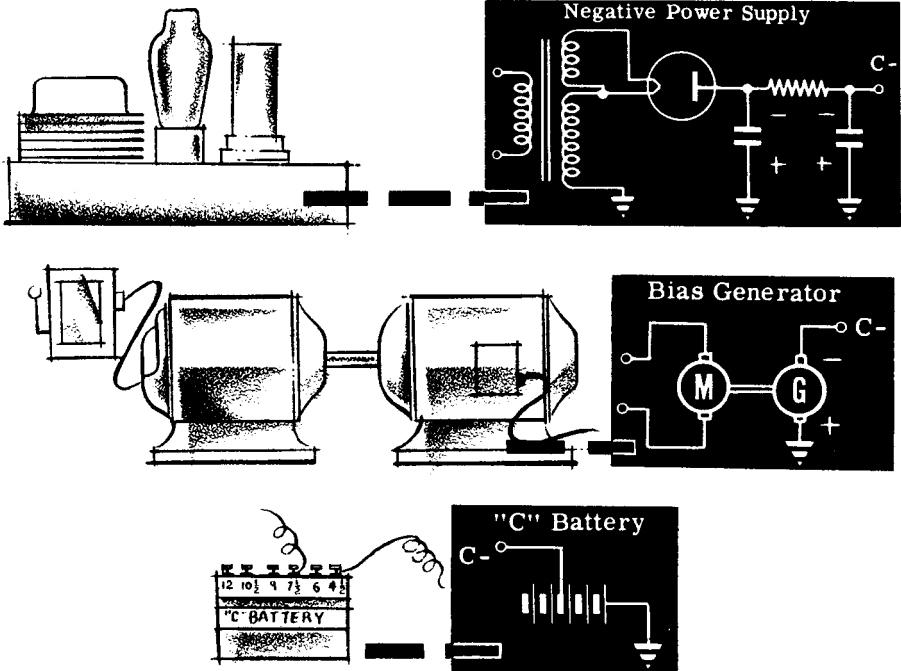

One of the advantages of fixed bias is that the tube remains cut off under no signal conditions.

The disadvantage of fixed bias is that the gain of the amplifier remains constant so that if the grid signal varies in amplitude, the output will similarly vary. This is not desirable in a transmitter because the output to the antenna must remain constant in amplitude if the radiated signal strength is to remain constant. If the bias could be made to vary as the signal input to the amplifier varies, the amplifier output could be maintained practically constant.

## CLASS C AMPLIFIERS

### Self-bias

The term "self-bias" describes any grid bias which results from the current flow in the vacuum tube that is being biased. You are already familiar with the two methods that are commonly used to provide self-bias.

A resistor placed in the cathode circuit makes the cathode more positive than ground and therefore makes the grid more negative than the cathode. The bias voltage developed across this resistor is equal to the average current times the size of the resistor. If a large cathode resistor is used, the bias voltage will be large. This resistor can be made large enough to cause the bias to approach cut-off when there is no signal on the grid.

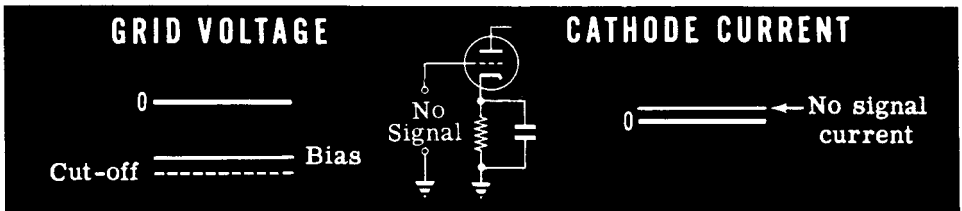

When there is a signal applied to the grid, the cathode current will increase on the positive half-cycles, and become zero (cut-off) on the negative half-cycles. The average current will be increased and the bias will increase.

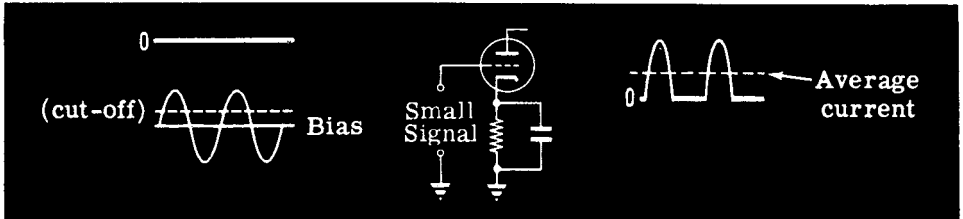

If a larger signal is applied to the grid, the current will be larger during the positive half-cycles of voltage but will remain zero during the negative halves. Thus, the average tube current increases as the grid signal becomes larger, resulting in increased bias for larger signals.

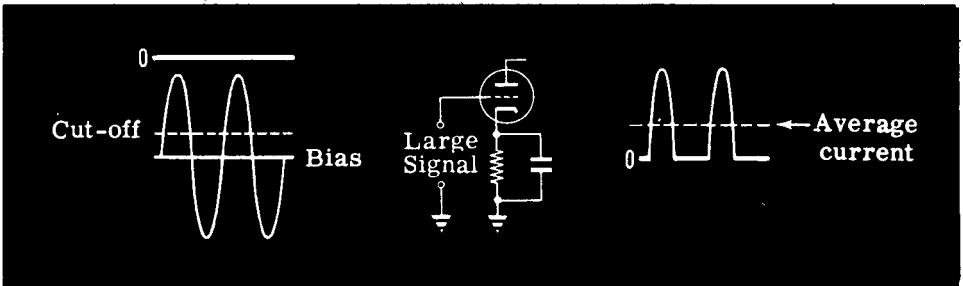

This effect of bias varying with signal strength tends to stabilize the amplitude of that portion of the grid signal above the cut-off level. As a result the amplitude of the current pulses in the plate will not vary as much as their corresponding grid signals vary. Because of the above mentioned effect, self-bias tends to produce amplitude stability of the plate signal and, therefore, is sometimes called "automatic bias." Cathode bias is not common in high-powered transmitter circuits.

## CLASS C AMPLIFIERS

### Self-bias (continued)

A very common type of self-bias arrangement found in transmitters makes use of the current that flows from the cathode to the grid at the positive peaks of the signal input. This is called "grid-leak bias."

### Class C Amplifier with *Grid-leak Bias*

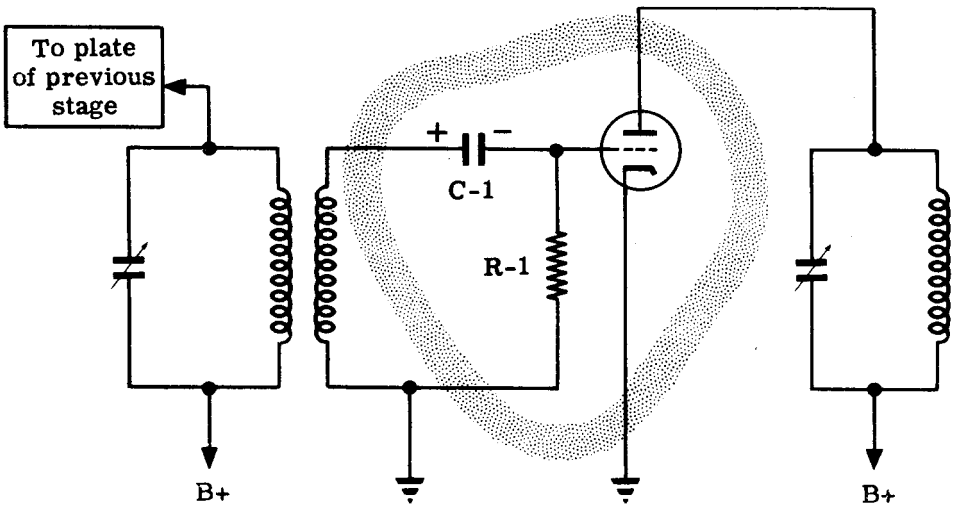

Whenever the signal drives the grid positive, the grid draws current and charges up capacitor C-1 to make the grid negative. Resistor R-1 provides a path for C-1 to discharge slightly between the pulses of grid current flow.

The main advantage of this type of bias is that it develops a voltage whose amplitude depends upon the strength of the input signal. If the input signal increases, the grid will draw more current and the bias will become more negative. After the new value of bias has become established, the peaks of this larger signal will not drive the grid very much more positive than a weaker signal would. Thus, the peaks of the larger signal will cause about the same amount of plate current to flow as the peaks of a smaller signal. In this way, grid-leak bias provides for amplitude stability.

The main disadvantage of grid-leak bias is that it depends entirely upon the presence of a signal in order to develop any bias voltage, and therefore doesn't protect the tube when there is no signal on the grid. If the oscillator of a transmitter stopped oscillating for any reason, the grid-leak arrangement in the amplifiers would not develop any bias since the grid would not, under these conditions, be driven positive. The transmitting tube would draw a very large current with zero bias and would burn out in a short time.

## CLASS C AMPLIFIERS

### Combination Bias

The most common bias arrangement in transmitters is a combination of fixed bias and grid-leak bias. The fixed bias is sufficient to limit the current to a low value or even to cut-off in the absence of a signal. When a large enough signal is present to drive the grid positive, grid-leak bias is developed which stabilizes the amplitude of the output. Thus combination bias protects the tube and stabilizes the output.

## Combination Bias

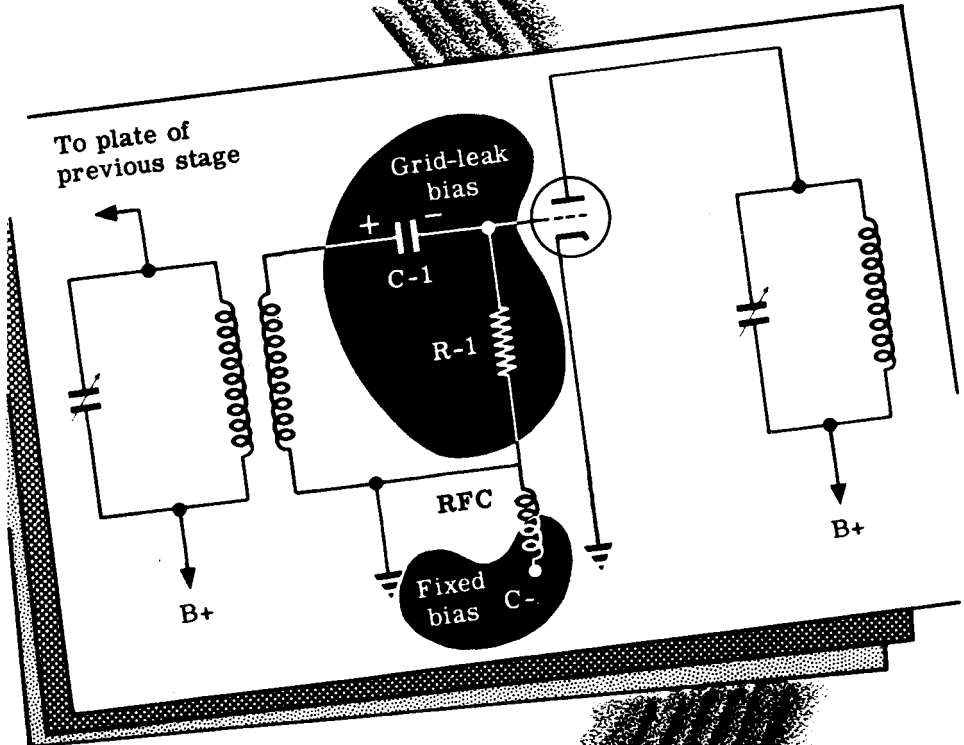



# CLASS C AMPLIFIERS

## Review of Class C Amplifiers

**CLASS C OPERATION**—The grid of the vacuum tube is biased well below cut-off so that plate current flows only in pulses.

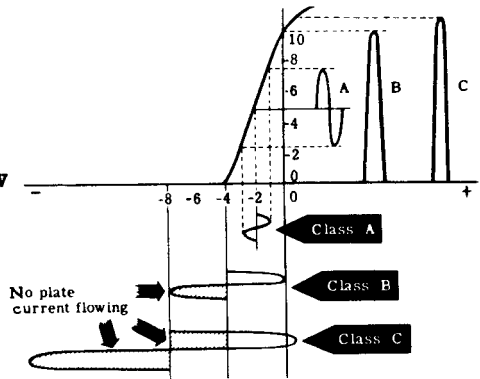

**TUNED CLASS C AMPLIFIERS**—Used in transmitters because they are very efficient when tuned to the frequency of the input signal.

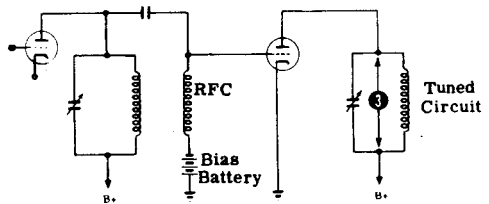

**GRID-LEAK BIAS**—Depends on grid current and varies as the strength of input signal changes.

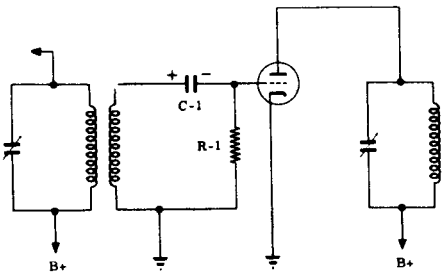

**COMBINATION BIAS**—A combination of fixed and grid-leak bias most commonly used in transmitters.

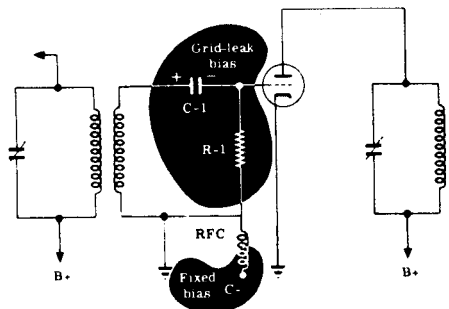

## A THREE STAGE TRANSMITTER

### The Three Basic Circuits

A block diagram of a basic three stage transmitter is shown below. All three stages are operated Class C for high efficiency. The ECO master oscillator (MO) generates the RF signal which can be varied, for example, from 2 to 4 megacycles.

The intermediate power amplifier (IPA) amplifies the RF signal and isolates the master oscillator from the final power amplifier to improve frequency stability. The IPA is therefore called a "buffer amplifier." The IPA may also act as a frequency doubler to double the oscillator frequency. The operation of a frequency doubler will be explained later. The output frequency of the IPA can therefore vary from 2 to 4 or 4 to 8 megacycles.

The final power amplifier (PA) generates a large amount of power output and delivers it to the antenna, usually at the same frequency as its grid signal.

### Basic

## THREE STAGE

## Transmitter

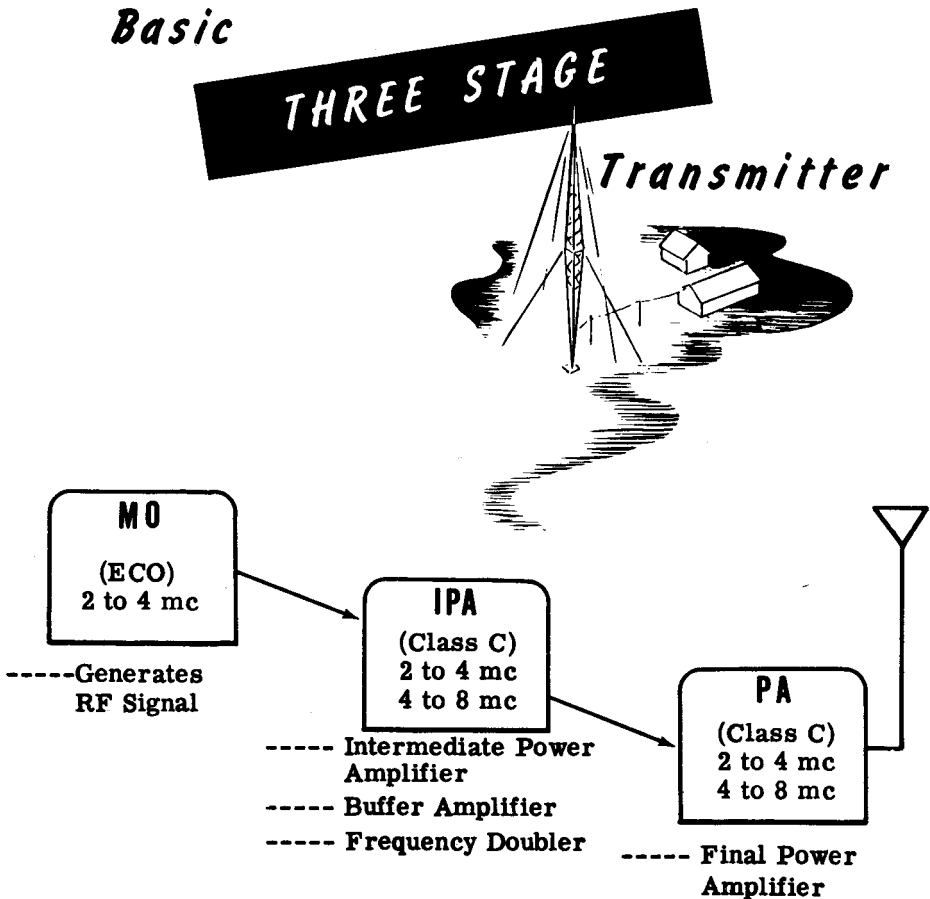

## A THREE STAGE TRANSMITTER

### The Oscillator

The purpose of the electron-coupled master oscillator is to generate a stable RF signal which can be varied over a given range.

The ECO operates as follows: The oscillator section of the ECO is composed of the grid and screen circuits and is a Colpitts oscillator. The oscillator frequency is determined by the grid-screen tank circuit consisting of L-1, C-1, C-2 and C-3. The screen, which acts as the plate of the oscillator section, is coupled to the tank circuit through the RF bypass capacitor, C-5. Grid-leak bias is developed across R-1 by the discharge of C-4. The RF choke in the cathode circuit provides a low resistance DC path to ground for the cathode. However, the high reactance of the choke to RF does not allow RF to flow through it. The RF must flow through C-3 (the feedback capacitor) to the cathode. The screen dropping resistor, R-2, drops the screen voltage to the correct value. The RF oscillations generated in the oscillator section of the ECO are electron-coupled to the plate through the flow of plate current. The RF choke in the plate lead acts as a high impedance for the RF signal and serves the same purpose as the plate load resistor in an audio amplifier. The RF coupling capacitor, C-6, passes the signal to the grid of the IPA.

### *Master Oscillator (ECO)*

...Generates RF Signal

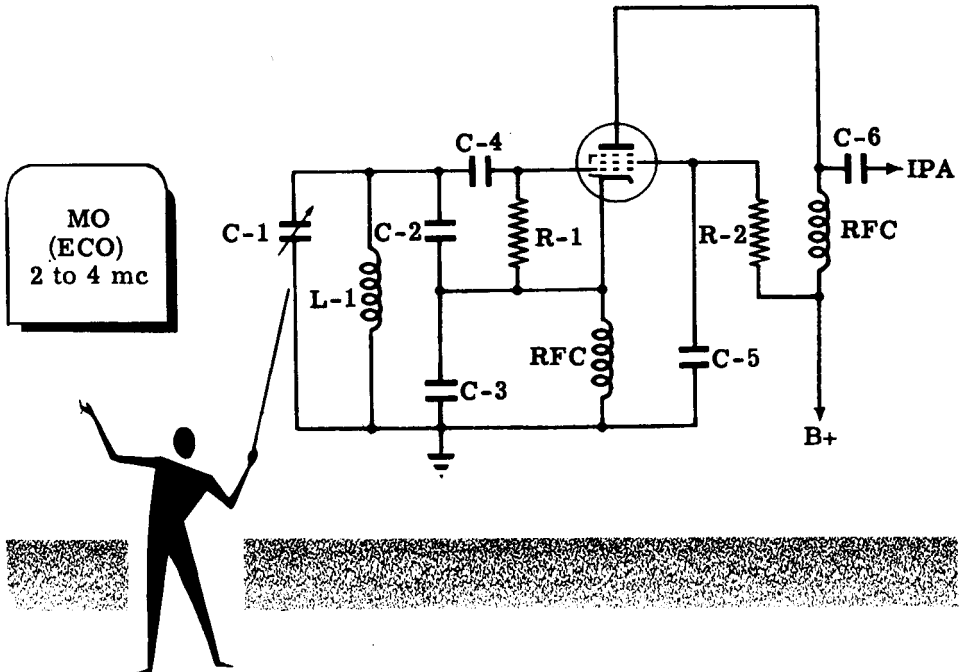

## A THREE STAGE TRANSMITTER

### The Intermediate Power Amplifier

The purpose of the intermediate power amplifier is to isolate the oscillator for improved frequency stability and to amplify the RF signal in order to drive the power amplifier efficiently. The IPA also serves to increase the tuning range, if desired, by doubling or tripling the generated frequency in its plate tank circuit.

The operation of the IPA is essentially as follows: A combination of grid-leak and cathode bias is provided by R-3, C-6 and R-4, C-7 respectively. Resistor R-5 drops the screen voltage to the correct value. The screen by-pass capacitor, C-8, is returned directly to the cathode rather than to ground. This provides a more direct path back to the cathode for any RF variations on the screen. The RF coil in the plate lead acts as a high impedance for the RF signal and serves the same purpose as the plate load resistor in an audio amplifier. C-9 is a coupling capacitor which passes the RF to the tank circuit and at the same time blocks the DC. The plate tank circuit, C-10 and L-2, can be tuned to the IPA grid signal, in which case the IPA is said to operate "straight through," or the tank circuit can be tuned to twice the grid signal frequency, and in this case the IPA is called a "doubler." When the IPA doubles, the isolation between the grid and plate circuits is improved and as a result there is less chance of the IPA breaking into oscillation. Doubling has another advantage in that it raises the carrier frequency while permitting the oscillator to operate at a lower frequency where it will be more stable. Capacitor C-11 couples the RF to the grid of the power amplifier.

### Intermediate Power Amplifier (IPA)

- ... Intermediate Power Amplifier
- ... Buffer Amplifier
- ... Frequency Doubler

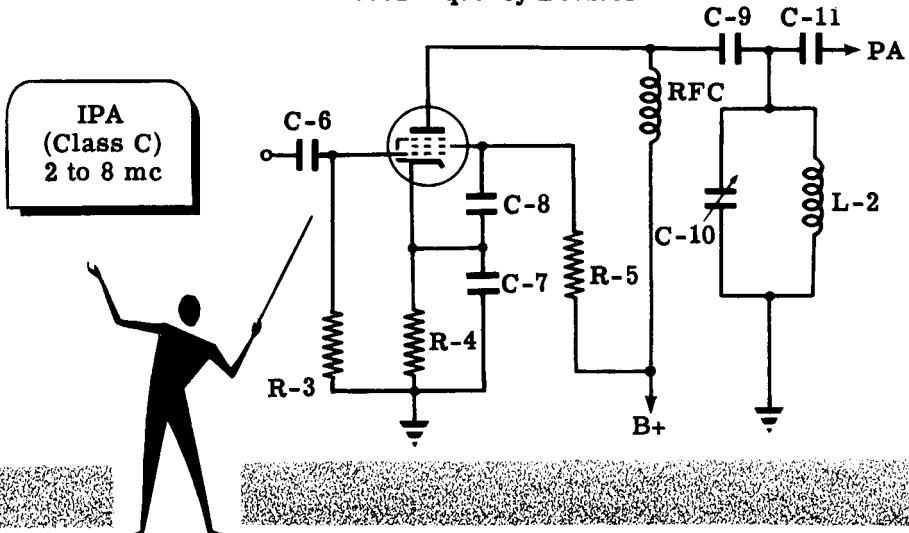

## A THREE STAGE TRANSMITTER

### The Power Amplifier

The purpose of the power amplifier is to increase the power of the RF signal so that it can be radiated by the antenna. The PA usually operates straight through for good efficiency. Only in unusual cases does the PA act as a doubler.

The PA operates as follows: Capacitor C-11 couples the RF from the output of the IPA to the grid of the PA. Here as in the IPA there is a combination of grid-leak and cathode bias provided by R-6 and C-11; and R-7 and C-12, respectively. The RF choke while providing a DC path from plate to B+ also acts as a high impedance plate load for the RF signal. C-13 couples the RF to the tuned circuit and blocks the DC.

The plate tank circuit C-15, L-3 is tuned to the grid signal frequency and a high RF voltage is developed across it. The high powered RF signal in the plate tank is coupled by coil L-5 to the antenna for radiation. Coil L-4 couples some energy back to the grid through capacitor C-14, called a "neutralizing capacitor." The purpose of the neutralizing circuit will become apparent shortly.

### *The Final Power Amplifier (PA)*

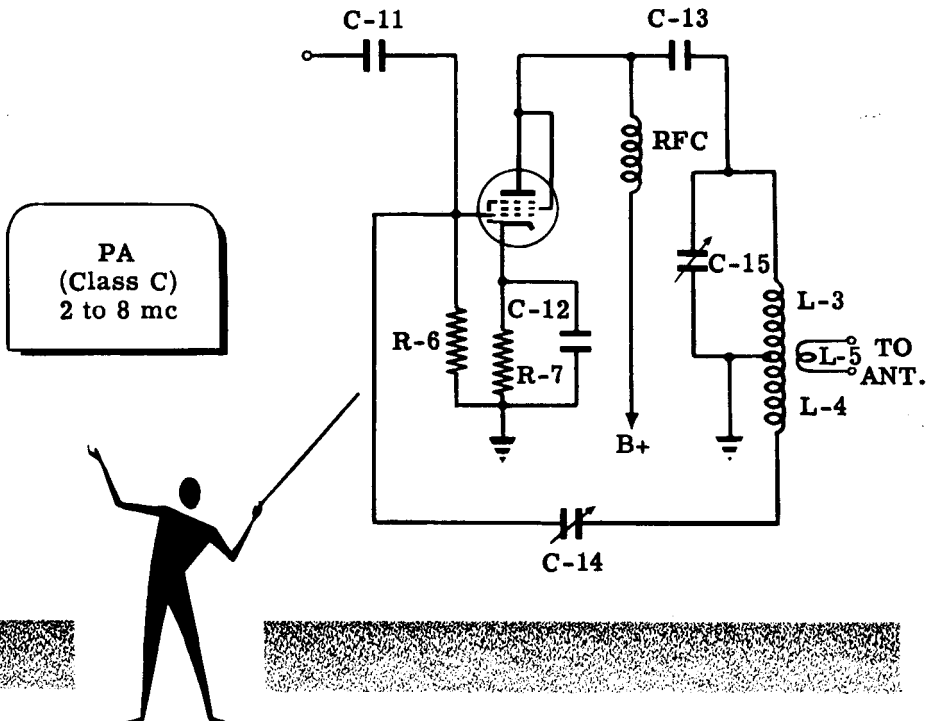

## A THREE STAGE TRANSMITTER

### Transmitting Tube Filament Circuit

Transmitting tubes used in many transmitters usually have directly heated cathodes which are capable of supplying the large current requirements. Tungsten cathodes are commonly used because of their relatively long life. However, the use of directly heated tubes complicates the wiring of the cathode circuit slightly, as shown.

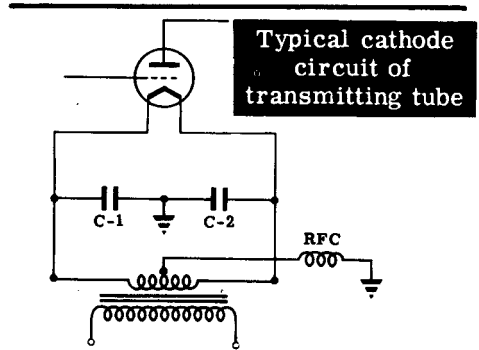

The filament is connected across a secondary winding of a filament transformer. This secondary winding is center-tapped to prevent the 60-cycle filament voltage from appearing in the plate signal of the tube.

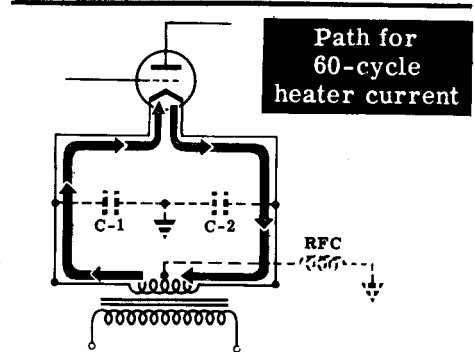

The center tap of the transformer is connected to ground through the RF choke to keep the RF current from flowing in the transformer winding. The RF current gets to the filament through C-1 and C-2.

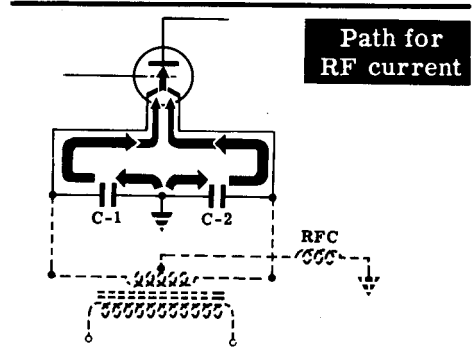

The DC tube current flows through the RF choke, divides in going through the filament transformer winding and arrives at the filament. Because the DC current divides, both ends of the filament are at the same DC potential. If one side were less positive than the other, more plate current would be drawn from that side. Since the two sides of the filament are at the same potential, equal currents are drawn from each, resulting in longer life for the tube.

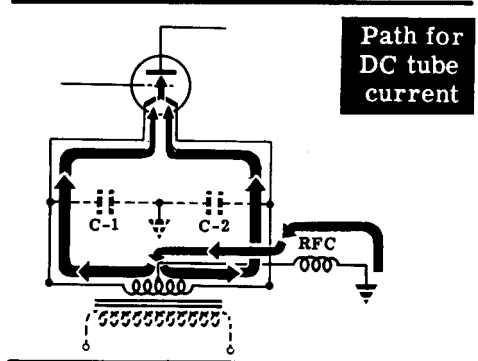

# A THREE STAGE TRANSMITTER

Complete Diagram of a Three Stage Transmitter

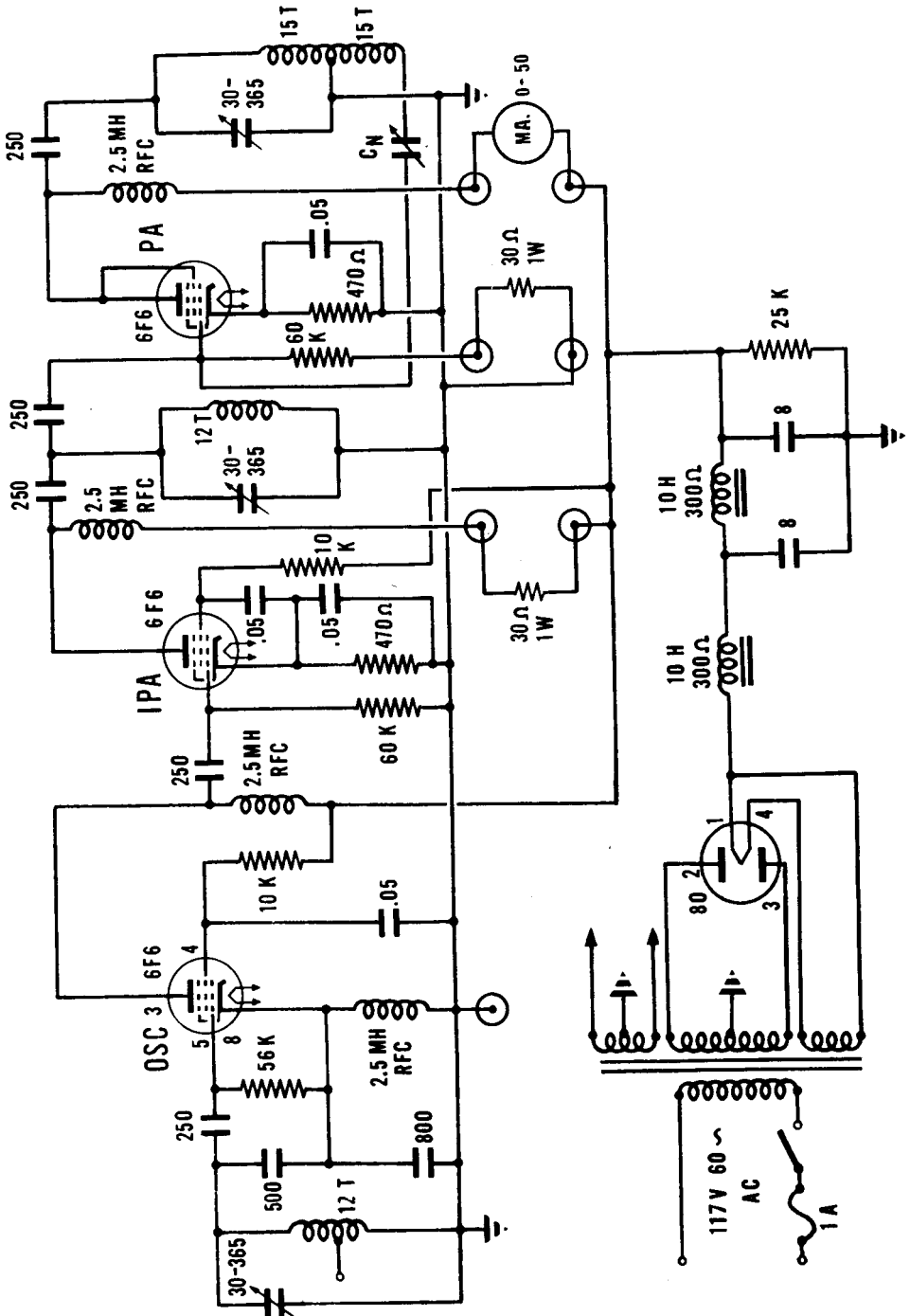

## A THREE STAGE TRANSMITTER

### Purpose of Tuning

If a Class C amplifier is to operate efficiently, the plate tank circuit must resonate at the same frequency as the grid signal. If the tuning capacitor is variable, the plate circuit will be either on or off resonance depending upon the setting of the variable capacitor. Adjusting the variable capacitor to make the plate tank circuit resonate to the grid signal is called "tuning."

When a transmitter is detuned, a weak signal will be radiated and receivers tuned to the transmitter frequency may not pick up the signal.

When a transmitter is tuned to a given frequency, all the tank circuits in the transmitter are tuned to resonate at this given frequency. The transmitter then radiates a stable signal at maximum efficiency and maximum power output. Tuning a transmitter is therefore the most important procedure in its operation.

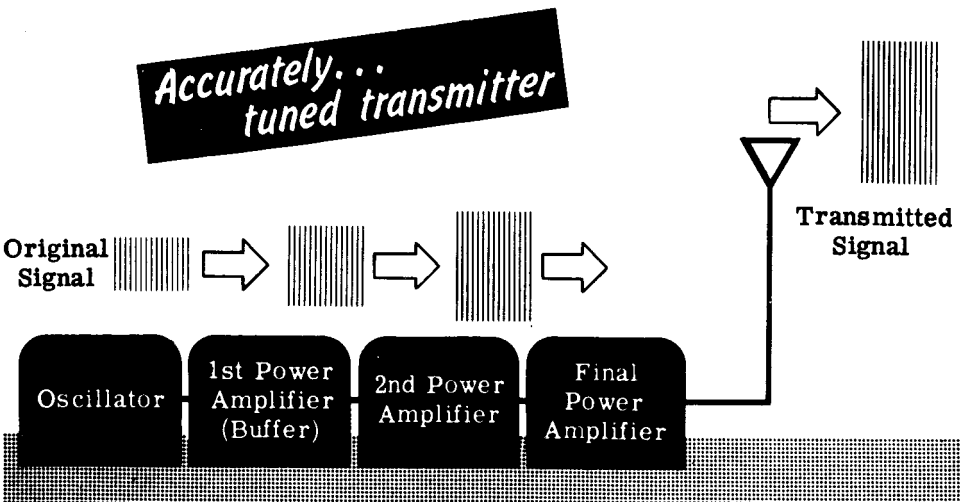
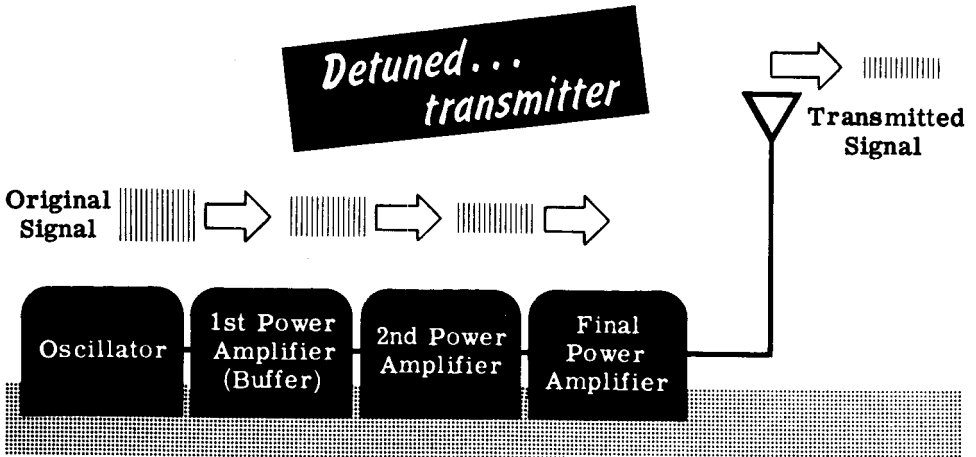



## A THREE STAGE TRANSMITTER

### Tuning Methods

A tank circuit in series with the plate of a Class C amplifier can be compared to a rheostat in series with the plate. When the plate circuit is completely detuned, it acts just as if there were no resistance in the plate. As a result, plate voltage will always be equal to B+ and the pulses of plate current (when grid is driven above cut-off) will be large. The DC meter (M-1) which measures the average of the current pulses will therefore read high.

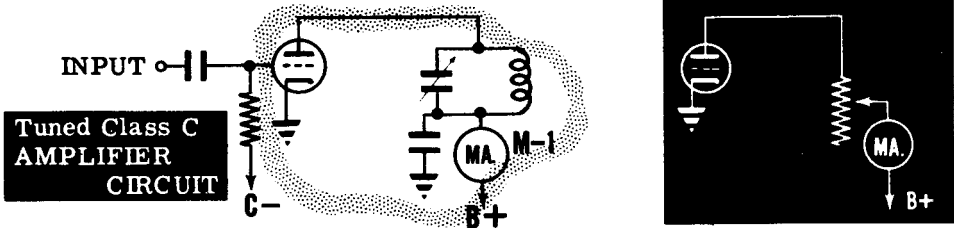

As the tuning is varied so that the resonant frequency of the tank circuit comes closer to the grid signal frequency, the impedance of the plate circuit rises above zero. Now a signal voltage appears across this impedance. Just as in an ordinary amplifier, when the grid signal is positive the plate voltage drops because of the voltage drop across the plate load resistor. Since the plate voltage is now lower than before (lower than B+) during the time the grid is driven above cut-off, the pulses of plate current will be lower in amplitude, and therefore their average value will be less. When the plate tank is tuned to the grid signal, the plate impedance is at its highest point and therefore the voltage drop across this impedance is at its highest point. As a result, the plate voltage (the difference between B+ and the load voltage) is at its lowest point. Since the plate voltage is at its lowest point (during the time the grid is above cut-off), the plate current pulses and therefore the average plate current will be at their lowest point.

A minimum DC plate current reading is therefore an indication that the plate tank is tuned to the grid signal frequency. When a plate tuned circuit is tuned for a minimum reading on the plate current meter, it is called tuning for a "dip."

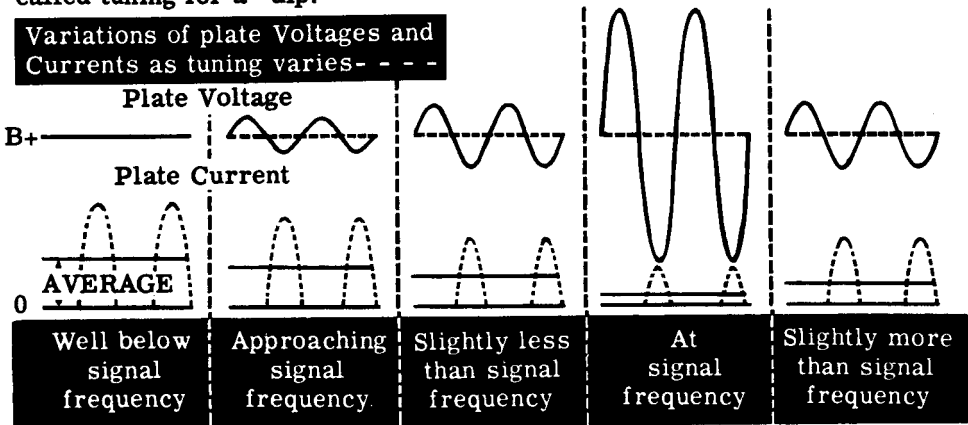

## A THREE STAGE TRANSMITTER

### Tuning Methods (continued)

The first step in tuning a transmitter is to set the oscillator to the desired frequency. This may be done by using a standard frequency meter which is calibrated and set to the desired frequency. The output of the oscillator in the transmitter (called the "master oscillator") is then zero-beat with the frequency meter at which point the master oscillator is set to the desired frequency.

The next stage to be tuned is the stage which follows the master oscillator. This can be done by observing the plate current for a minimum indication when the plate circuit is tuned to the master oscillator frequency. Initially this stage is detuned and the plate current is at a fairly high value.

As the tuning control is rotated, no change in the milliammeter reading will be noticed until the tuned circuit frequency is near the oscillator frequency. When the current starts to "dip," the control should be rotated slowly.

The current will continue to decrease as the tuning control is rotated until a minimum value occurs. This is the dip reading.

Continuing to rotate the control in the same direction will detune the circuit and the current will rise again.

When the current is observed to be rising, the control should be turned in the opposite direction until it is set for minimum current. At this point, the tuned circuit is at the same frequency as the signal frequency and the output of the stage is maximum.

The plate tank circuits of the other stages can be tuned in exactly the same way.

### TUNING THE TRANSMITTER

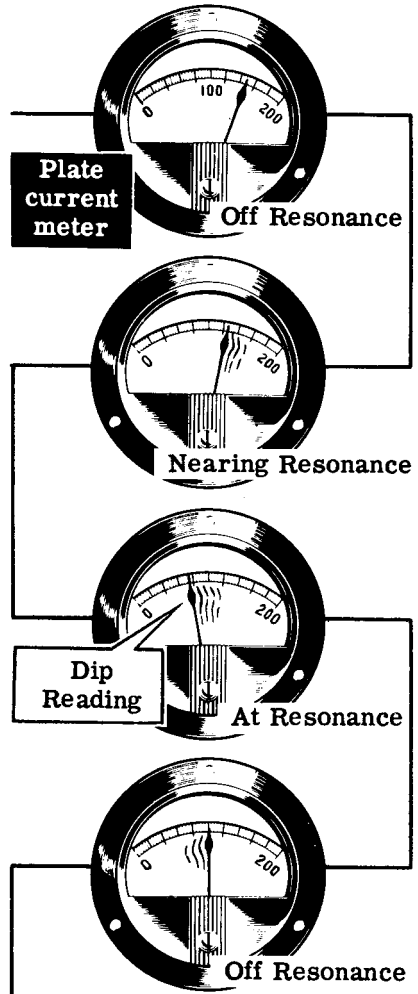

## A THREE STAGE TRANSMITTER

### Tuning Methods (continued)

In addition to the plate current meter, there is another meter which indicates correct tuning of the plate circuit. This meter is in the grid circuit of the following stage and is labeled M-2 in the diagram below.

When the plate circuit is tuned to the frequency of the input signal, the voltage developed across the circuit is greatest and the output from that amplifier stage is greatest. The larger the output from that stage, the greater is the signal to the grid of the following stage.

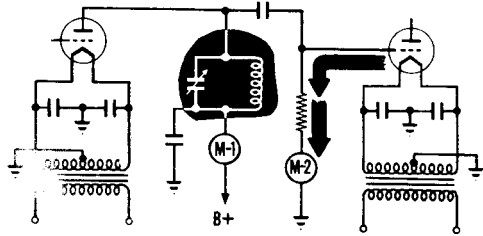

The grid of the following stage will draw current whenever the input signal drives the grid positive. The larger the signal input, the greater will be the flow of current from the cathode to the grid. Since the signal input to the grid will be greatest when the plate circuit of the previous stage is accurately tuned, the grid will draw maximum current and milliammeter M-2 (which measures the average grid current) will indicate a maximum reading. Thus when the plate tank is accurately tuned, the plate current meter indicates a dip and the grid current meter of the following stage simultaneously registers a rise known as a "peak" reading.

**Plate Current ••** *decreases when* •• **Grid Current ••** *increases*

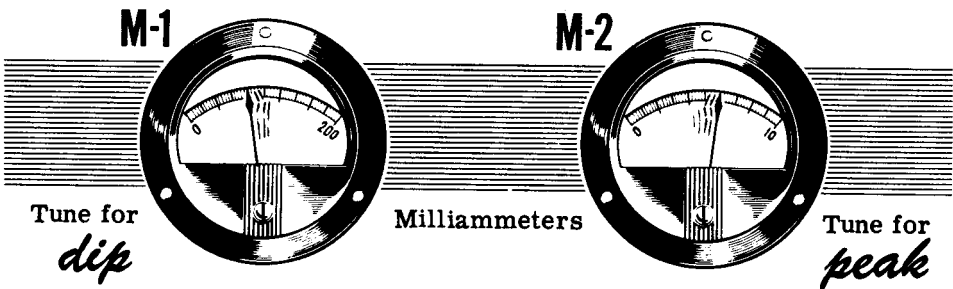

If the grid circuit has fixed bias or combination bias, no grid current will be drawn until the signal is fairly large. This will happen some time after the plate current meter has started to dip. For this reason, the rising grid current indication is sharper than the decreasing plate current indication.

The normal procedure for tuning a stage which has a plate current meter and is followed by a stage which has a grid current meter, is to tune first for a minimum plate current. This indication is broader and less likely to be overlooked as you vary the tuning. After you have observed the plate current starting to decrease, you watch the grid current meter for a rise. The final adjustment will be for a rise in grid current. Since this is a sharper indication, tuning based on this indication will be more accurate.

# A THREE STAGE TRANSMITTER

## Tuning Methods (continued)

When a plate tank circuit is tuned to the same frequency as the grid signal, the voltage across the tank is at its maximum. If another coil is transformer coupled to the coil of the tank circuit, the voltage induced in this coil will also be a maximum. This second coil can be connected to a pilot lamp which will glow if the induced voltage is large enough. If the tank circuit is detuned from the grid signal, the induced voltage in the lamp circuit will drop and the lamp will go out. The transformer coupled lamp is therefore a convenient means of tuning a tank circuit as the lamp is brightest when the tank circuit is tuned to the signal frequency.

This method of tuning is not as accurate as the current meter indications because the lamp circuit loads down the tank circuit and detunes it slightly. When using this method for tuning indication, the coupling must be kept as loose as possible to minimize the detuning effects on the plate tank circuit. The lamp method of tuning can be conveniently used on built up experimental transmitters in which the plate coils are accessible. In many transmitters this method cannot be used since the tuning coils are out of sight, and therefore tuning is done exclusively by current meter indications.

## Using a lamp for tuning . . .

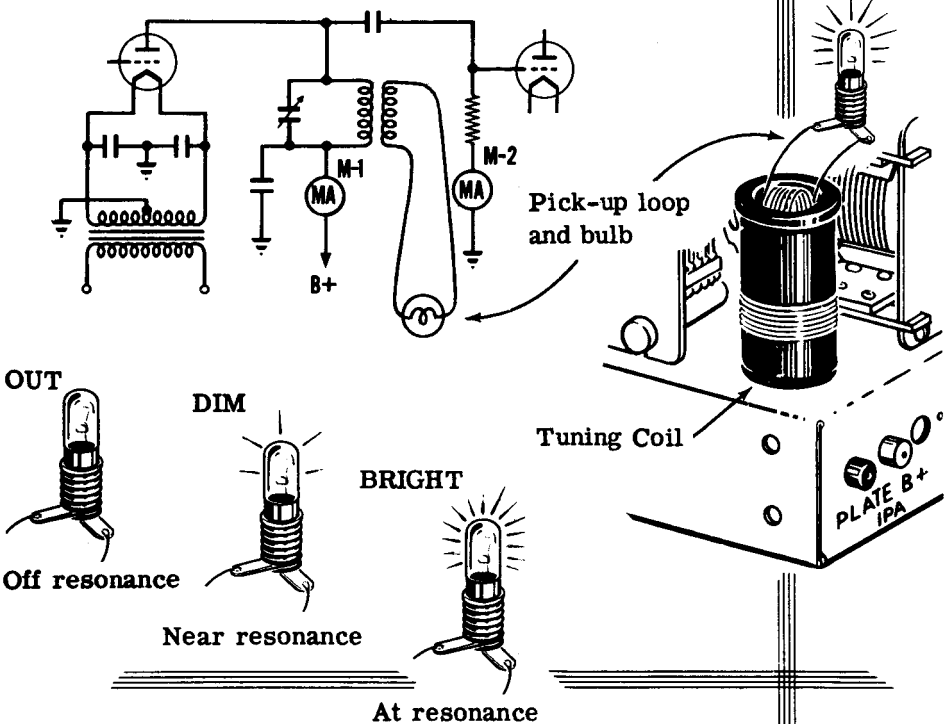

## A THREE STAGE TRANSMITTER

### Neutralization

Sometimes a tuned Class C amplifier will act as a tuned-plate—tuned-grid oscillator at the resonant frequency of the tuned circuits. In this case, the interelectrode capacitance between plate and grid is large enough to provide the proper amount of feedback for sustained oscillations. This type of oscillation is most often encountered with triodes because of their large interelectrode capacities. Tetrodes and pentodes rarely have this problem of oscillations because their interelectrode capacities are very low. When triodes are used as RF amplifiers, it is possible to eliminate the above mentioned oscillations by a process called "neutralization." In neutralization a circuit is included in the amplifier which counteracts the feedback effect of the interelectrode grid to plate capacity.

Two circuits are used to neutralize the grid-to-plate capacitance and thereby reduce the possibility of oscillations. Each of these circuits accomplishes neutralization by feeding back a signal from the plate to the grid through a neutralizing capacitor. This signal is opposite in phase and equal in magnitude to the signal fed back through the grid-to-plate capacitance. These circuits are called "plate neutralization" and "grid neutralization" and get their names from the part of the circuit in which the feedback voltage is developed.

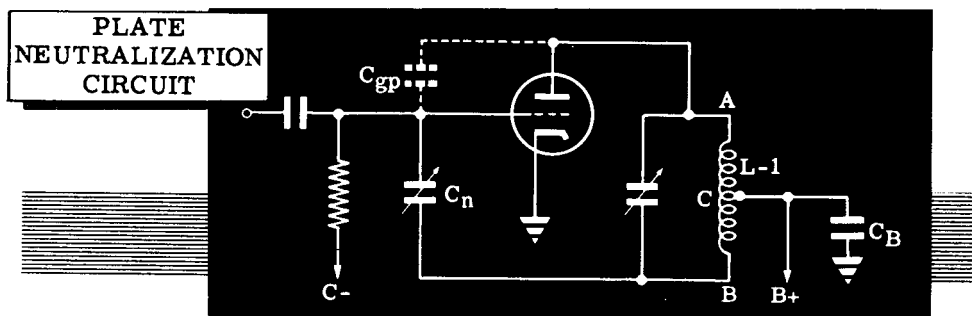

This is the circuit for plate neutralization.  $C_{gp}$  is the grid-to-plate capacitance represented in the schematic as a capacitor external to the tube.  $C_n$  is the neutralizing capacitor—that is, the capacitor through which the neutralizing signal is brought to the grid. The tuning coil, L-1, is center-tapped at point C, which is placed at RF ground by the RF bypass capacitor  $C_B$ . Since points A and B are at opposite ends of coil L-1, they are 180 degrees out of phase. Therefore the RF voltages measured at points A and B with respect to ground are 180 degrees out of phase and equal in amplitude (assuming point C is the exact center-tap).

The neutralizing capacitor,  $C_n$ , is connected between point B and the grid, while the interelectrode capacitance,  $C_{gp}$ , is connected between point A and the grid. Therefore the phase of the voltage fed from the plate to the grid through  $C_n$  is opposite to the phase of the voltage fed through the grid-to-plate capacitance and the voltages cancel.  $C_n$  is made variable so that the amplitude of the signal fed back through  $C_n$  can be made to balance out exactly that fed back through  $C_{gp}$ .

## A THREE STAGE TRANSMITTER

### Neutralization (continued)

In the plate neutralization circuit just considered, both plates of the tuning capacitor and one plate of the neutralizing capacitor are at a high DC potential with respect to ground. Therefore, the rotor of the tuning capacitor must be insulated from ground. In many common types of tuning capacitors the rotor is common to the capacitor frame, and therefore an insulated mounting must be provided to keep the capacitor frame insulated from the chassis.

If a grounded rotor tuning capacitor must be used, the plate neutralization circuit can be modified so that no DC voltage is present on the rotor plate as illustrated below. In the schematic on the left, the rotor of the tuning capacitor is grounded. The tap on the coil is grounded for RF through the 0.05 mfd RF bypass capacitor. The tap is also connected to B+ through a radio frequency choke. Observe that only part of the coil from A to B is in the tuned circuit. The remainder of the coil from B to C is transformer-coupled to the A-B portion of the coil, and thus picks up RF for the neutralizing circuit.

In the other schematic the tuned circuit is capacity-coupled to the plate so that the DC plate current flows only through the radio frequency choke. One side of the tuning coil and tuning capacitor connect directly to ground, and the tuning and neutralizing circuits are completely isolated from DC.

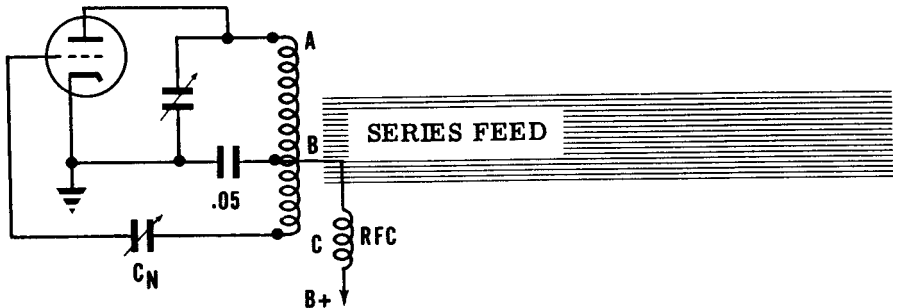

## PLATE NEUTRALIZATION

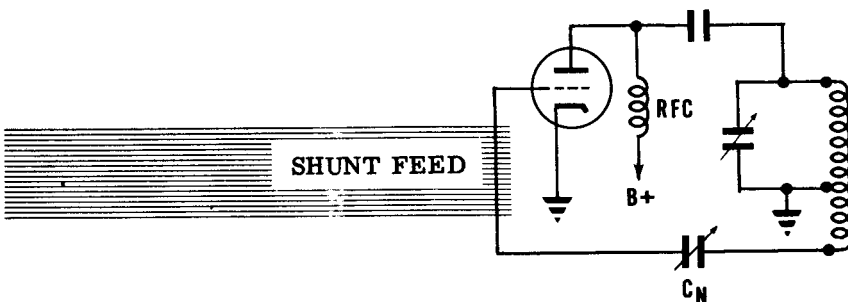

Neutralization (continued)

# Grid Neutralization Circuit

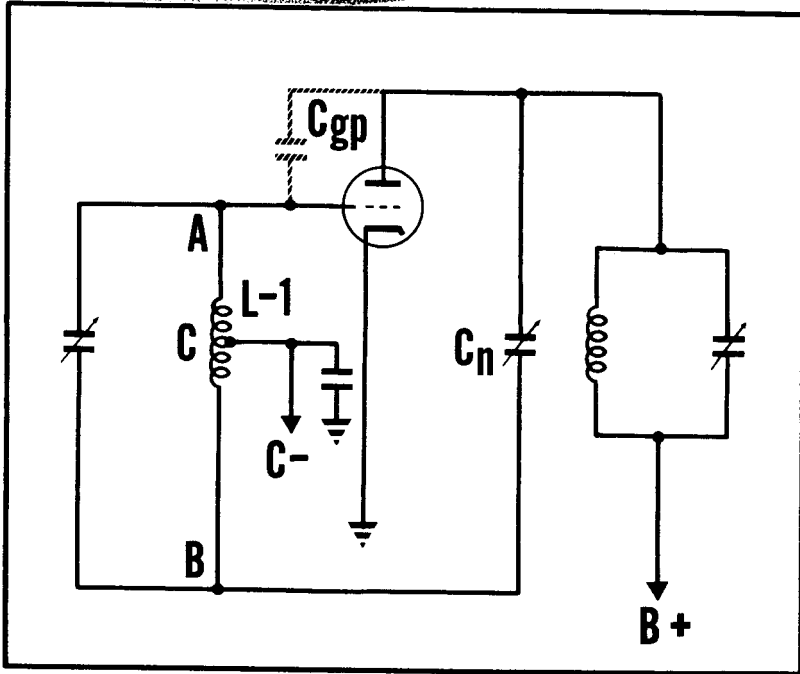

Another circuit which provides a means of neutralizing the grid-to-plate capacity is the grid neutralization circuit. In this circuit the neutralizing voltage is applied to end B of the center-tapped coil L-1 while the grid-to-plate feedback voltage is applied to end A of coil L-1. Since these two voltages are equal and of the same polarity, they cause currents to flow in the balanced grid tank circuit whose effects cancel each other. The result is that oscillations due to feedback cannot occur in the grid tank circuit and therefore the entire stage will not be able to oscillate. Therefore if C<sub>n</sub> is adjusted to be equal to C<sub>gp</sub>, the voltages coupled through these capacitors will cancel each other and the tube will not oscillate.

Once a neutralizing capacitor is adjusted for a particular tube, it will require only occasional checks. However, if the tube is changed for a new one, the neutralizing capacitor will need adjustment since the new tube will have a slightly different value of C<sub>gp</sub>.

# A THREE STAGE TRANSMITTER

## Neutralizing Procedures

The procedures for neutralizing are almost independent of the type of neutralizing circuit used. At the start of neutralization, the plate voltage is removed from the stage to be neutralized so that any signal present in the plate circuit is due to the interelectrode capacity coupling between the grid and plate.

Then the master oscillator and those amplifier stages which precede the unneutralized stage are tuned. This will provide a strong signal to the grid of the unneutralized stage. The next step depends on the indicator used but it always results in the adjustment of the neutralizing capacitor until there is a minimum amount of energy transferred to the plate circuit.

If there is a grid current meter, the grid current can be used to indicate the correct adjustment of the neutralizing capacitor. When this capacitor is not properly adjusted, the grid current will dip as the plate circuit is tuned through resonance. When the circuit is properly neutralized, there will be no dip in the grid current when the plate circuit is tuned to resonance.

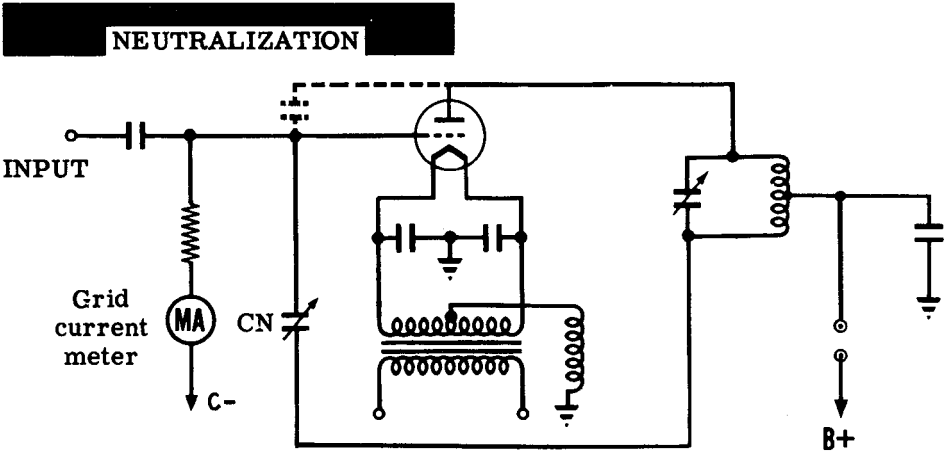

### Effect of varying PLATE TUNING ON GRID CURRENT

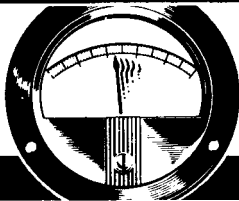

**LARGE DIP**  
when stage is  
poorly neutralized

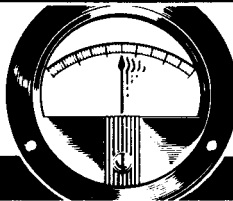

**SMALL DIP**  
when neutralization  
is improved

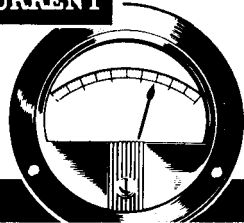

**NO DIP**  
when properly  
neutralized



## A THREE STAGE TRANSMITTER

### Neutralizing Procedures (continued)

Other methods used to adjust the neutralizing capacitor make use of devices which can indicate the presence of RF energy in the de-energized plate circuit. Some devices which can be used for this purpose are the oscilloscope, a neon lamp, a small flashlight bulb or a sensitive DC milliammeter. The device chosen affects the accuracy of neutralizing but not the method of adjusting the neutralizing capacitor

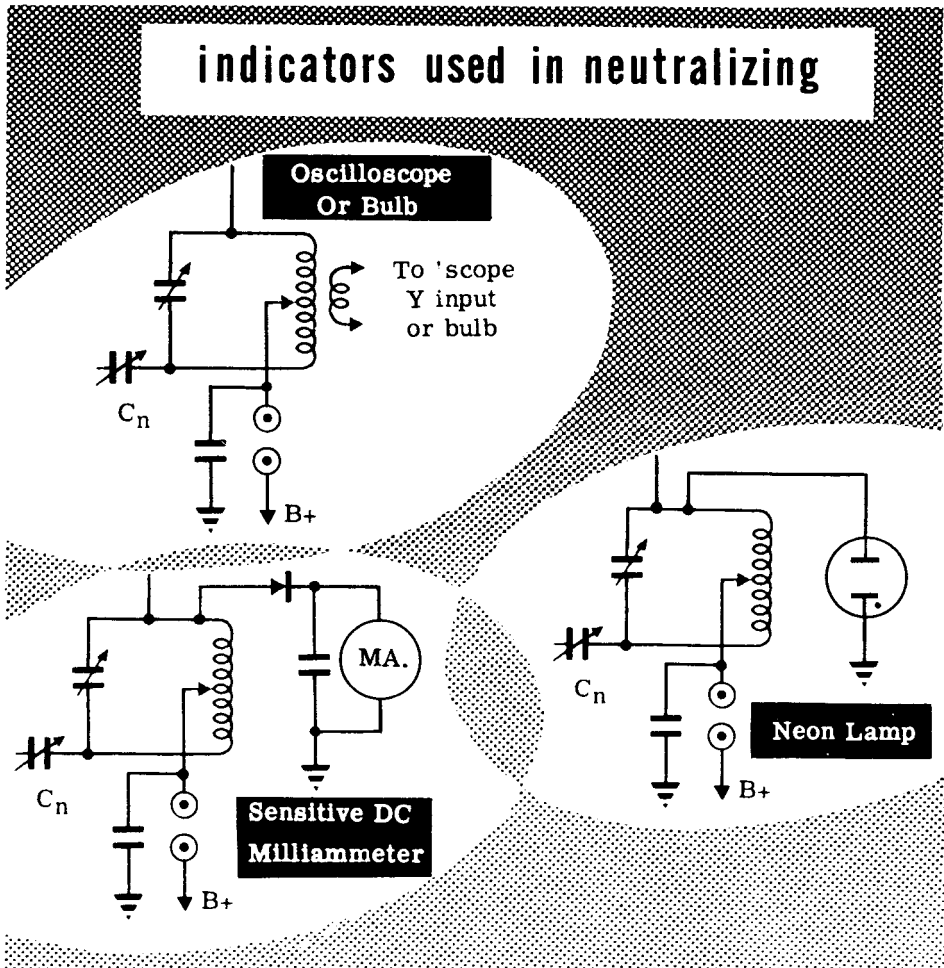

As before, the circuits in the transmitter that precede the unneutralized stage are tuned to provide a strong signal to that stage. The plate supply voltage is disconnected from the plate of the stage and when the plate is tuned to resonance, the indicator will show either a maximum current flowing in the tuned circuit or a maximum voltage across the tuned circuit. The plate circuit remains tuned to resonance and the neutralizing capacitor is adjusted until the voltage across (or the current in) the tuned circuit is a minimum as shown on the indicating device.

## A THREE STAGE TRANSMITTER

### Parasitic Oscillations

In a transmitter which is operating correctly, the tuned Class C amplifiers serve only to amplify the RF generated by the master oscillator. Sometimes the inductance of wires in the circuit combine with stray capacities to form tuned circuits which are resonant to frequencies much higher than the desired transmitted frequency. These stray tuned circuits will often cause the amplifiers to oscillate at very high frequencies. These oscillations, called "parasitic oscillations," are transmitted together with the desired frequency. Parasitic oscillations are undesirable because they cause undue power losses and reduce the efficiency of the transmitter. In addition, they cause interference with other transmitters.

One way to eliminate parasitic oscillations is to improve the wiring by shortening leads and relocating components which may be in the parasitic oscillatory circuit. If this does not help, low value resistors or chokes of a few turns of wire should be connected directly to the grid and plate leads. These added components have very little effect on the amplification of the desired frequency. They do, however, isolate the grid from the stray tuned circuits to the point where the parasitic oscillations are eliminated. Components which are placed in a circuit to eliminate parasitic oscillations are called "parasitic suppressors." Very often parasitic oscillations can be eliminated only by completely rewiring a circuit.

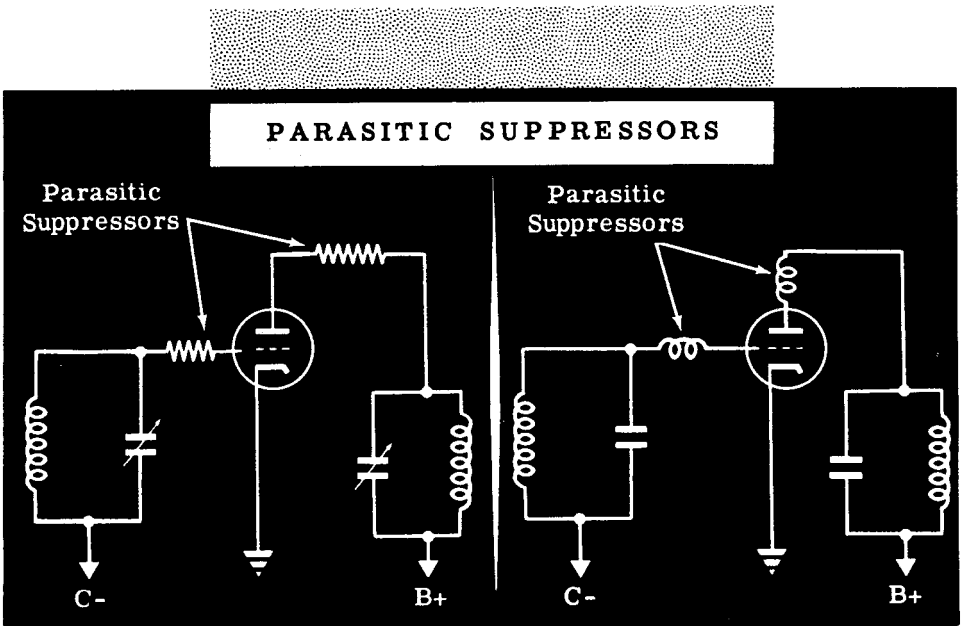

# A THREE STAGE TRANSMITTER

## Review of the Three-Stage Transmitter

**THE THREE STAGES**—The master oscillator, intermediate power amplifier and final power amplifier make up the basic three-stage transmitter.

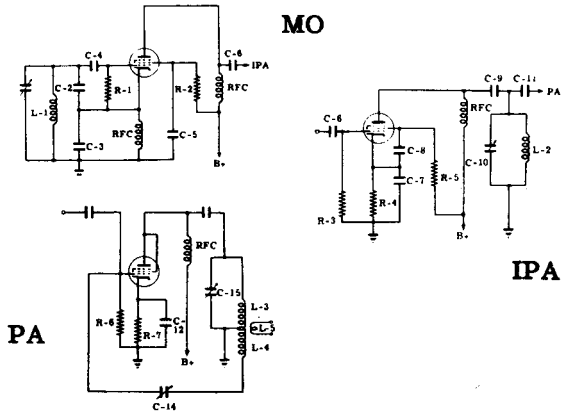

**TUNING**—For efficient operation, the plate tank circuit of the amplifier must resonate at oscillator frequency. Adjusting the variable capacitor to reach this condition is called "tuning."

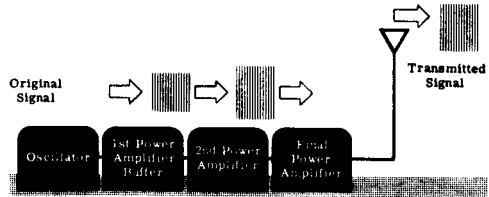

**TUNING METHODS**—The plate circuit of each transmitter stage may be tuned by adjusting the variable capacitor for minimum DC plate current.

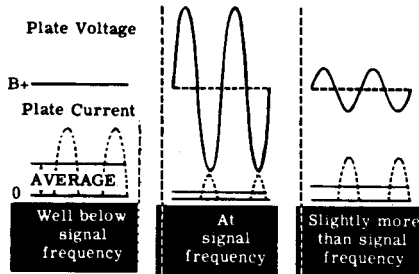

**NEUTRALIZATION**—Plate or grid neutralization circuits may be used to counteract the feedback effect of the grid to plate capacity in amplifiers using triodes.

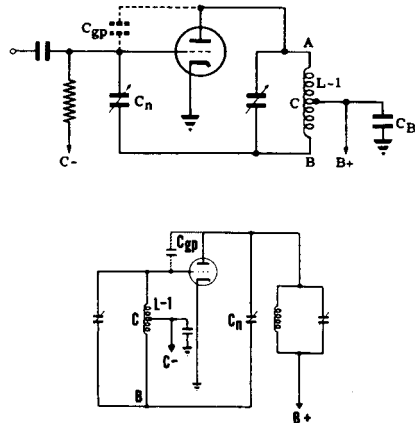

## FREQUENCY MULTIPLIERS

### Purpose of Frequency Multiplication

Up until now, it has been assumed that the plate-tuned circuit of an amplifier stage in a transmitter can be tuned only to the grid signal frequency, whatever that may be. For example, if the grid signal frequency is 1 mc, the plate circuit is also tuned to 1 mc.

If the grid signal is a pure sine wave, the plate circuit can be tuned only to the frequency of this sine wave (called the fundamental) and none other. It so happens that generated frequencies are very seldom pure; they usually contain harmonics of the fundamental frequency. This is especially true in transmitters where Class C amplifiers introduce many harmonics into the generated signal. For example, if the master oscillator (operating Class C) generates a 1 mc sine wave, that sine wave is rich in harmonics—it contains not only the fundamental (1 mc) but also the second harmonic (2 mc), the third harmonic (3 mc), etc. Therefore if a signal rich in harmonics is placed on the grid of a tuned amplifier, the plate can be tuned to any one of the harmonics that is present in the original grid signal. The process by which the input frequency to the grid is converted to a higher one in the plate by tuning to a harmonic of the fundamental is called "frequency multiplication." For example, if the output of the oscillator is 1000 kc, the output of the buffer amplifier might be 2000 kc (second harmonic) and of the next amplifier 4000 kc (fourth harmonic).

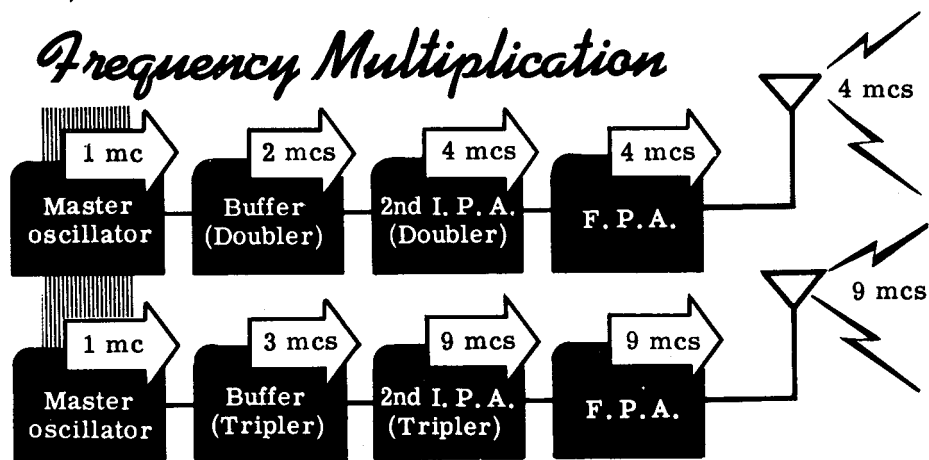

The reason that frequency multiplier circuits are used in transmitters is that an oscillator operates more satisfactorily at low frequencies. Therefore, if a high frequency is required, the oscillator operates at a low frequency and the multiplier circuits step up the oscillator frequency to the desired one.

For very high frequencies, crystal oscillators are used to provide for good frequency stability. However, it is impractical to manufacture a crystal to vibrate at such high frequencies. Therefore, the crystal oscillator is operated at a much lower frequency and the desired output frequency is obtained by frequency multiplication.

## FREQUENCY MULTIPLIERS

### The Final Power Amplifier

The maximum power which can be radiated from a transmitting antenna depends on the power output of the final power amplifier (FPA). If the final power amplifier has a power output of 100 watts, the antenna can radiate no more than 100 watts.

A frequency multiplier has a lower output than the same stage used as a straight frequency amplifier. If the final power amplifier which is capable of an output of 100 watts as a straight frequency amplifier were used as a doubler, its power output would be about 65 watts—as a tripler, 40 watts; as a quadrupler, 30 watts and so forth. As the multiplication of the frequency increases, the power output decreases.

Because the power output of a transmitter depends to a great extent upon the output of the final power amplifier, the FPA is not operated as a frequency multiplier. Thus all the multiplication of the oscillator frequency must take place in the intermediate power amplifiers.

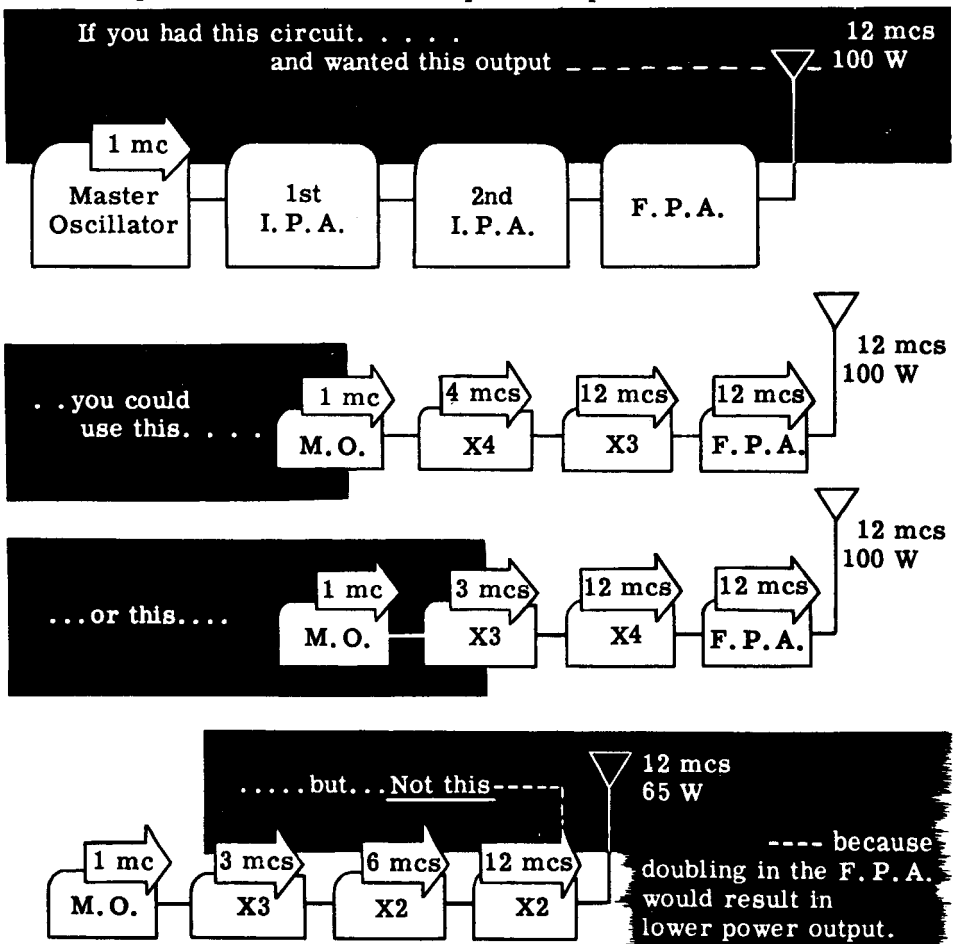

## FREQUENCY MULTIPLIERS

### Frequency Doubling

Let's examine a typical doubler circuit—that is, one in which the output frequency is twice the input frequency—and see how it works.

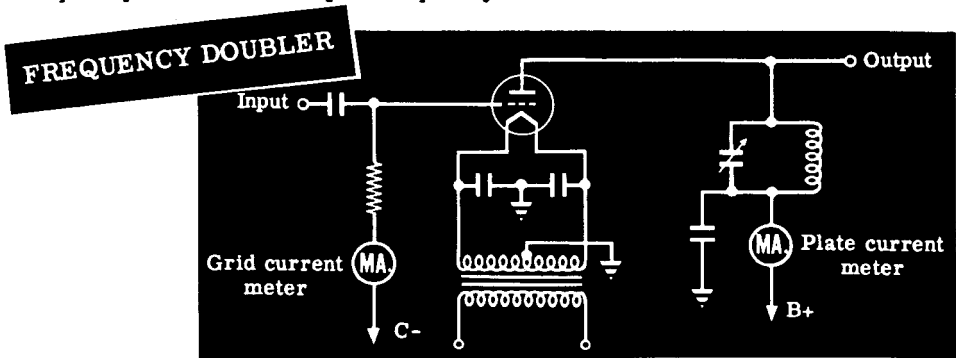

The circuit of a frequency doubler appears to be the same as that of an amplifier which operates at the input frequency. The only differences are that the plate circuit will be tuned to twice the input frequency and no neutralization is required since the input and output operate at different frequencies. This reduces the possibility of self-excited oscillations.

### WAVE FORMS IN A TYPICAL DOUBLER CIRCUIT

The doubler circuit is operated Class C with the plate tank resonant to twice the grid signal frequency. The pulses of current at the same frequency as the input signal flow from the cathode to the plate, energizing the plate tank circuit and causing it to oscillate at twice the grid signal frequency. Between pulses of plate current, the tank circuit continues to oscillate.

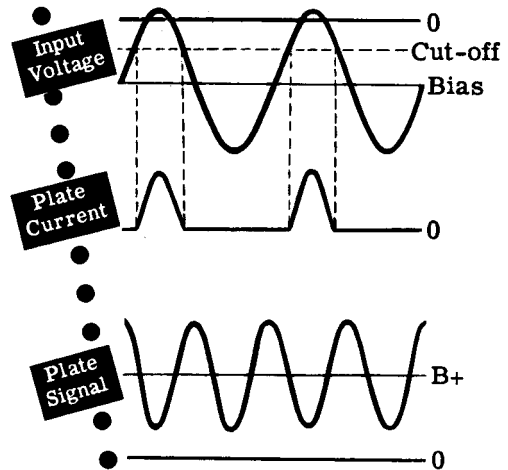

The reason the tuned circuit continues to oscillate is that the pulses of current always arrive at the same time during alternate cycles of the doubled frequency, thus energizing the tank circuit at the right time. When accurately tuned, the voltage across the doubler-tuned circuit is at a maximum and the voltage at the plate is at a minimum when current flows. Therefore, the indications for tuning to twice the frequency are the same as for tuning to the input frequency. The plate current meter will indicate a dip as the plate circuit is tuned to twice the input frequency. At the same time, the grid current meter will indicate a rise.

# FREQUENCY MULTIPLIERS

## Frequency Tripling

A frequency-tripling circuit, or more briefly a tripler, has an output frequency that is three times the input frequency. The appearance of the circuit is the same as that of a doubler or of an ordinary amplifier. Frequency tripling is accomplished by tuning the plate circuit of the tripler to the third harmonic of its input frequency.

**Wave forms in a typical tripler circuit**

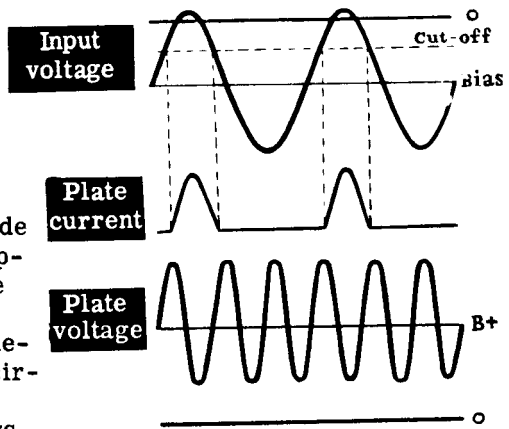

Pulses of current flow from cathode to plate—one pulse per cycle of applied signal. These pulses arrive at the tuned circuit during every third cycle of output voltage and deliver enough energy to the tuned circuit to sustain oscillations during those cycles when no current flows.

The same tuning indications hold for frequency doubling and tripling as for fundamental frequency amplification. When the circuit is tuned accurately to the third harmonic of the applied frequency, the voltage across the tuned circuit will be larger than if the circuit were poorly tuned. This will cause the voltage fed to the next stage to be larger, which results in more grid current. The larger voltage across the accurately tuned circuit causes the plate voltage to be at a low value when the tube conducts. This results in decreased plate current. Therefore the tuning of the plate circuit—whether it is tuned to the input frequency or to the second or third harmonic of the input frequency—can be indicated as a dip on the plate current meter or as a rise on the grid current meter of the following stage.

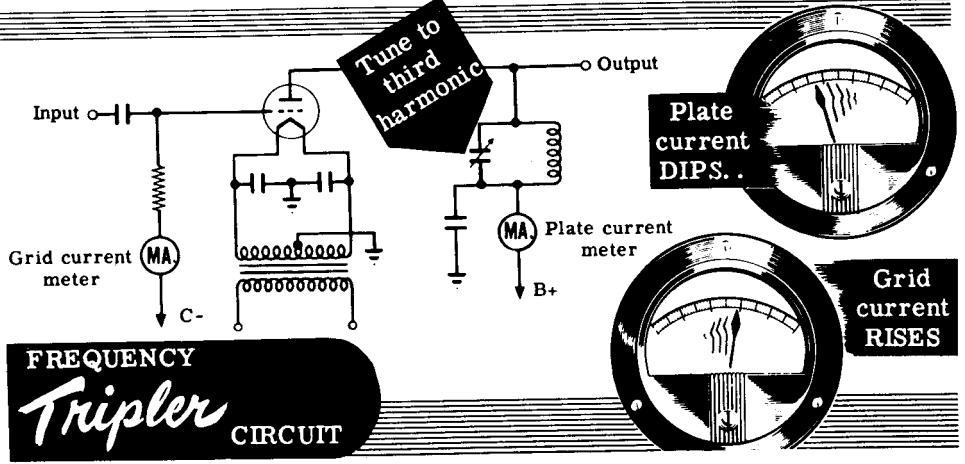

**FREQUENCY Tripler CIRCUIT**

# FREQUENCY MULTIPLIERS

## Tuning Indications

At this point the question arises "How can you tell to what frequency the plate tank circuit is tuned when the plate current meter indicates a dip reading?" The only way to tell is to use a frequency indicator such as a wavemeter, or a calibrated dial if the tuned circuit has been previously tuned. If you are working with an uncalibrated transmitter, the thing to do is to tune a stage, starting with the tuning capacitor fully meshed. The first dip indicates that the tank circuit is tuned to the fundamental. This can be checked with the wavemeter. As you continue decreasing the capacity, you come to a second dip (not as pronounced as the first one) which is the second harmonic. Again you can check the frequency with a wavemeter. Continue decreasing capacity and you may come to a third dip (provided the circuit constants are correct) which is not as pronounced as either the first or second dip. This dip indicates that the plate-tuned circuit is tuned to the third harmonic. Here too you can check the resonant frequency by using a wavemeter.

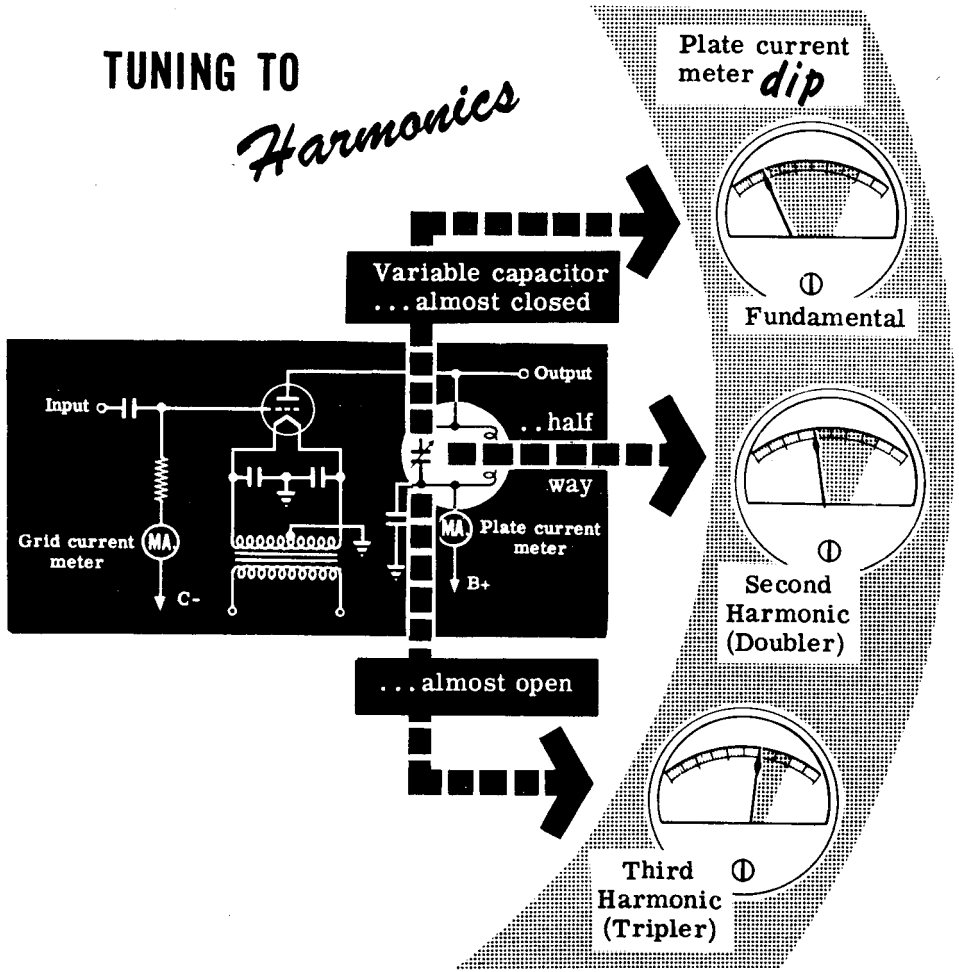



## TRANSMISSION LINES

### The Overall Transmitter

The end result of transmitter operation is the radiation of RF energy for great distances through space so that this energy can be detected by remote receiving antennas.

You have studied oscillator and Class C amplifier circuits whose function it is to generate and amplify RF energy. Other circuits are needed, in addition to the ones just mentioned, to transfer the amplified RF from the plate circuit of the final power amplifier to surrounding space. These additional circuits are transmission lines, antennas and coupling circuits. Just as a speaker in audio work transfers audio energy from electronic circuits into the air, so the antenna is the means of transferring RF energy from the electronic circuits into space. The transmission line is the conveyor or link between the transmitter and the antenna; and the coupling circuit connects the final power amplifier tank circuit to the transmission line.

## HOW RF IS DELIVERED FROM TRANSMITTER TO SPACE

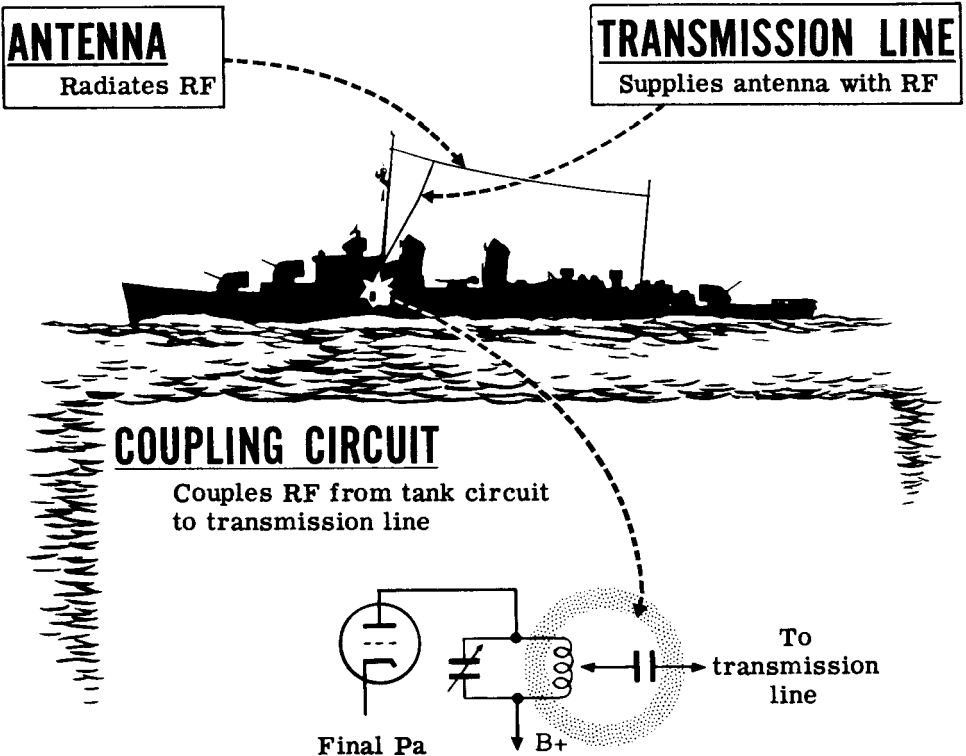

In this topic you will learn about transmission lines and coupling circuits —what they are like and how they do their job. Antennas will be discussed separately in the next topic.

# TRANSMISSION LINES

## Coupling Circuits

A coupling circuit is used to transfer energy from the output of the transmitter to the transmission line which feeds the antenna. In doing its job of transferring energy, the coupling circuit isolates the antenna system from the high DC potentials present in the plate of the final power amplifier. The coupling circuit also determines the amount of coupling that is required for maximum power transfer from the plate tank circuit of the power amplifier to the line input.

The simplest coupling circuit is direct coupling from the tank circuit to a single wire transmission line. A small capacitor is always placed at the input to the line to block the DC from the antenna. The coupling is adjusted by varying the tap on the plate tank coil.

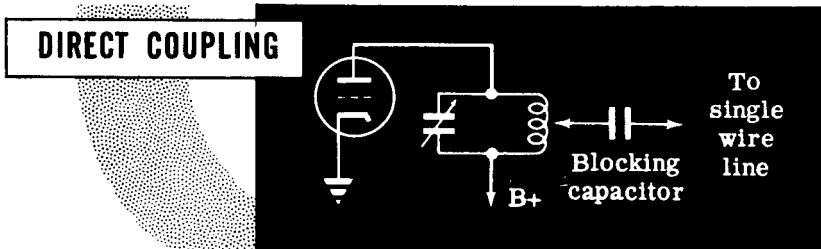

Another simple coupling circuit is inductive coupling to the plate tank circuit with an untuned coil of a few turns. This type of coupling is used principally with flat lines (to be discussed later).

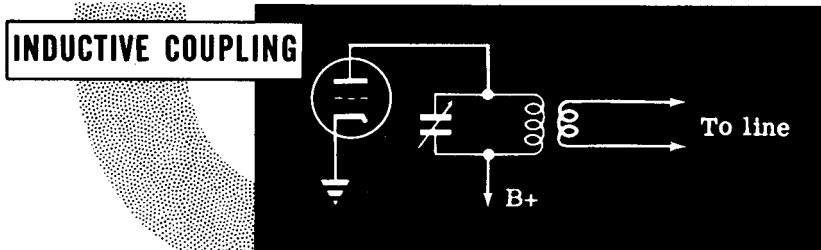

A system of untuned coupling called "Link Coupling" is used when the antenna coupling is remote from the plate tank circuit. The link consists of two pick-up coils of about two or three turns connected by wires and coupled to the plate tank and the antenna coupling circuit, respectively.

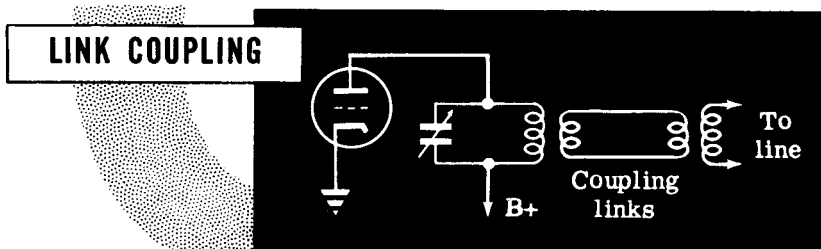

## TRANSMISSION LINES

### Tuned Coupling Circuits

A more commonly used type of coupling is tuned coupling in which the coupling circuit is tuned to the operating frequency. The advantage of tuned coupling is that it insures greater selectivity and minimizes the possibility of undesired frequencies being radiated. In addition, since the tuned coupler is almost always variable tuned it can compensate for changes in the impedance of the transmission line and thus insure maximum power transfer from the final power amplifier to the line at all times.

When the transmission line has a low input impedance, a series-tuned coupling circuit is used. Series tuning is called "current feed," and can match the final PA to the low line impedance.

#### *Series* TUNED COUPLING

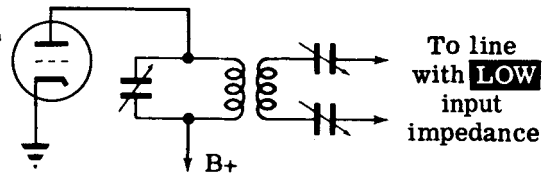

When a transmission line has a high input impedance, parallel tuning, called "voltage feed," is used. Here the high impedance of the parallel tank circuit matches the high input impedance of the line, and maximum power transfer is effected.

#### *Parallel* TUNED COUPLING

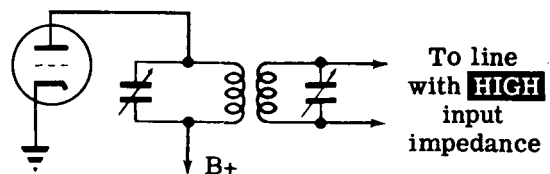

If the input impedance of the line is other than pure resistive, either of the above two tuned coupler circuits can be adjusted so that the reactance of the line is cancelled by the reactance of the tank circuit. This results in a pure resistive load, which is the requirement for maximum power transfer.

## TRANSMISSION LINES

### Transmission Lines

A transmission line provides a means of transferring electrical energy from one point to another. You know of at least one application of a transmission line in carrying 60 cycle power from the generator to the point of application.

In transmitters, transmission lines are similarly used to convey RF power from one point to another. For example, a transmission line is always used to carry RF power from the transmitter to the antenna when the antenna is some distance from the transmitter.

### *Transmission Lines . . . . .*

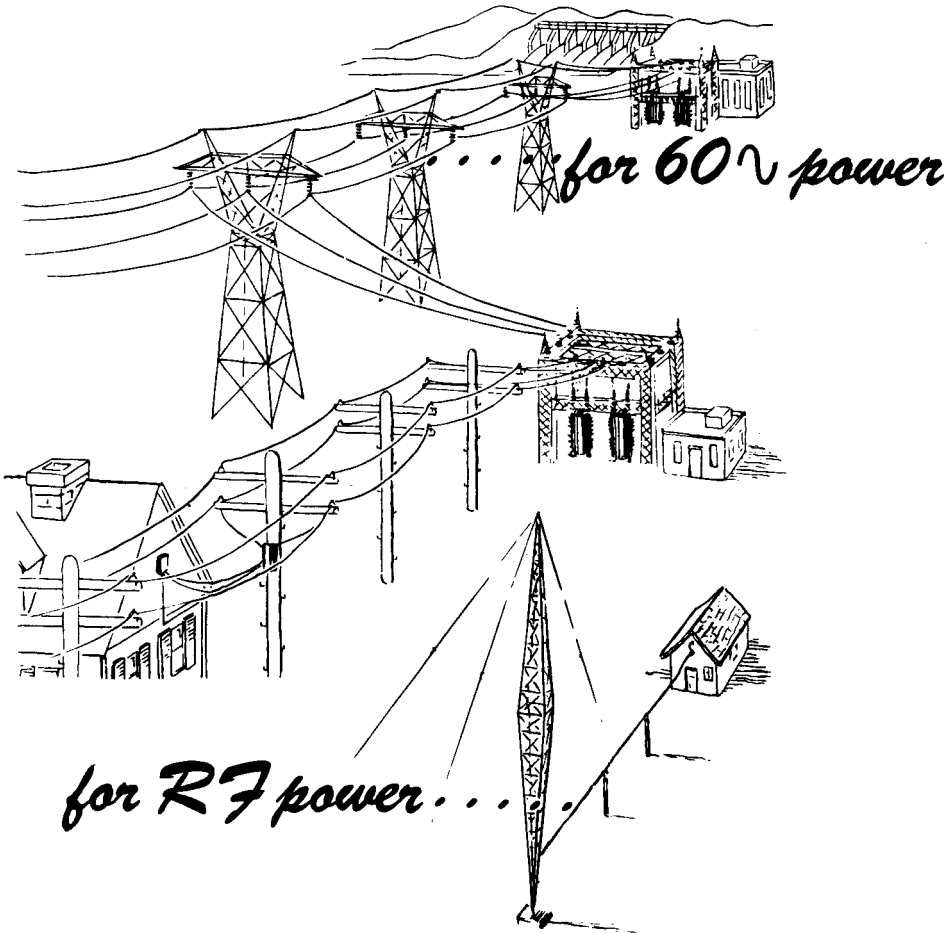

Transmission lines play an important part in the operation of a transmitter, not only to convey RF energy but also as circuit components.

## TRANSMISSION LINES

### Frequency and Wavelength

Before you learn the theory of transmission lines, you should understand something about the properties of a radiated wave—its velocity of propagation (how fast it travels), its frequency and its wavelength.

For purposes of simplicity consider an AC generator sending 60 cps energy along a transmission line from New York to California by way of Kansas. Assume that the rate of travel of the AC power is the same as the velocity of electromagnetic radiation in free space which is constant at 186,000 miles per second or 300,000,000 meters per second regardless of the frequency.

If the generator starts its generating action at the zero voltage point on the sine wave, after a half cycle has elapsed ( $\frac{1}{120}$  of a second in time), the zero voltage point will have traveled a distance which can be determined by multiplying the velocity of the wave by the time duration for a half cycle. This distance equals about 1550 miles ( $186,000 \times \frac{1}{120}$ ) which is approximately the distance from New York to Kansas.

**DISTANCE TRAVELLED  
IN  $\frac{1}{120}$  OF A SECOND**

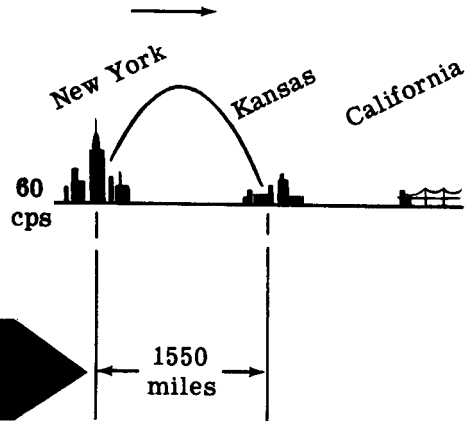

When another half cycle or a total of a full cycle has elapsed ( $\frac{1}{60}$  of a second), the zero voltage point will have traveled a distance of 3100 miles ( $186,000 \times \frac{1}{60}$ ) which is the approximate distance from New York to California. This distance of 3100 miles is the wavelength of the 60 cycle AC, which is the distance that the wave travels during the time interval for one cycle. The symbol for wavelength is the greek letter " $\lambda$ ".

**DISTANCE TRAVELLED  
IN  $\frac{1}{60}$  OF A SECOND**

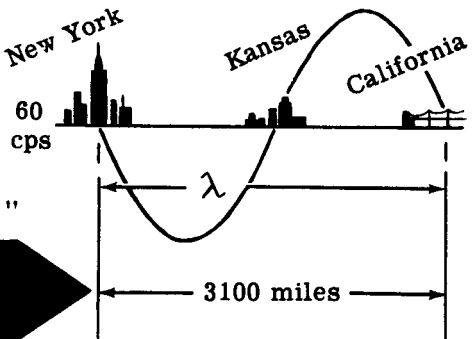

Similarly the wavelength of any frequency radiation can be determined by multiplying the constant velocity by the time for one cycle. Since the time for one cycle is equal to 1 divided by the frequency ( $\frac{1}{f}$ ), the wavelength equals constant velocity over frequency ( $\lambda = \frac{V}{f}$ ) or the velocity equals the frequency times the wavelength ( $V = f\lambda$ ). Since  $V$  is constant, the higher the frequency, the lower the wavelength and vice versa.

From now on, transmission lines and antenna lengths will be defined in terms of wavelengths of the RF energy they are to radiate. For example, if an antenna is a half of a wavelength long it means that only one-half wavelength of the RF will be present on the antenna.

## TRANSMISSION LINES

### Equivalent Circuit of a Transmission Line

A typical transmission line used to convey RF energy from one point to another may consist of two parallel lengths of wire which are spaced apart at equal distances by insulating spacers as illustrated.

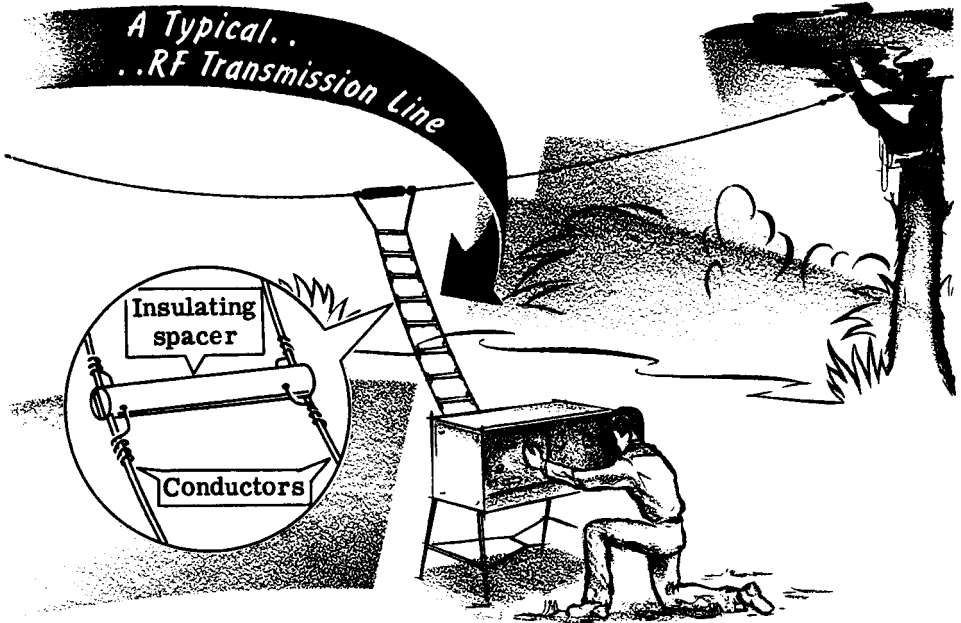

An RF transmission line will have a certain amount of resistance, capacitance and inductance along its length. The resistance is simply the resistance of the wire. The inductance is generated by the magnetic field (caused by current flow) expanding and collapsing along the entire length of the line, and the capacitance exists because the two conductors of the line act as plates of a capacitor separated by a dielectric (in the above case air). Since the line can be broken up into any number of small segments having equal amounts of inductance, capacitance and resistance, the entire line can be represented as consisting of a series of L, C, R networks connected as shown.

Transmission line and its equivalent circuit...

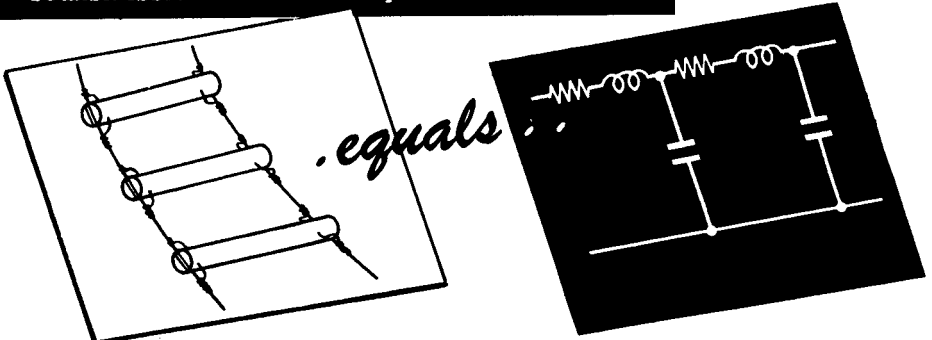

# TRANSMISSION LINES

## Characteristic Impedance

Suppose an RF generator is connected across a transmission line. The RF generator impresses a voltage across the line, which forces a current to flow. The amplitude of this current will be determined by the resistance, inductance and capacitance of the line, which together make up the line's impedance. If the magnitude of the input current is measured and divided into the input voltage, the input impedance ( $Z_{in}$ ) of the line is obtained. If the line is infinitely long, this input impedance defines the characteristic impedance of the line. The symbol for characteristic impedance is  $Z_0$ .

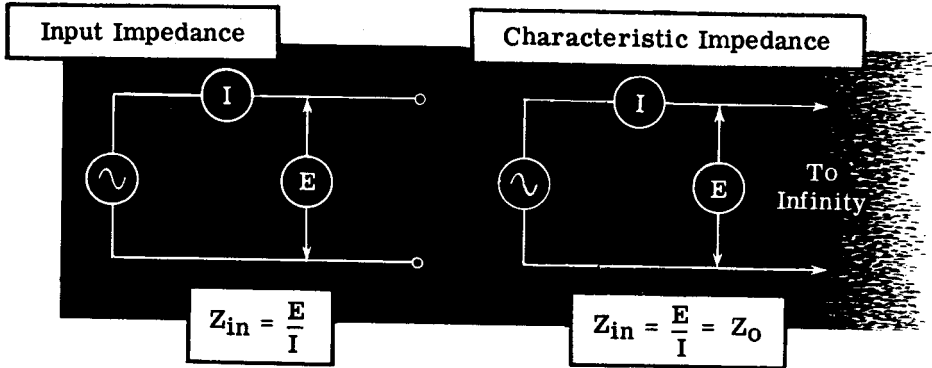

When a pure resistance loads down a generator, all of the power generated is dissipated by this resistance. Similarly when a generator sends electrical energy down an infinitely long transmission line, the electrical energy travels down the line indefinitely. In other words, all the electrical energy that the generator puts out is absorbed or dissipated by the infinitely long line. The infinite line therefore acts like a resistance equal in value to its characteristic impedance,  $Z_0$ . The infinite line can therefore be replaced by a resistance equal to its characteristic impedance and the generator will send the same amount of power into the resistance as it did into the infinite line.

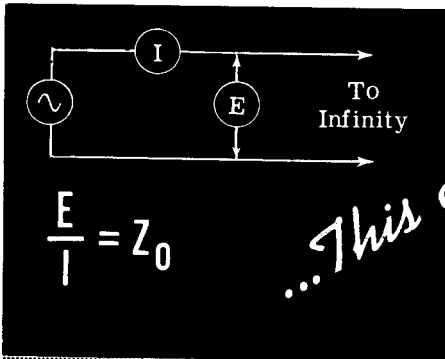

*... This equals this ...*

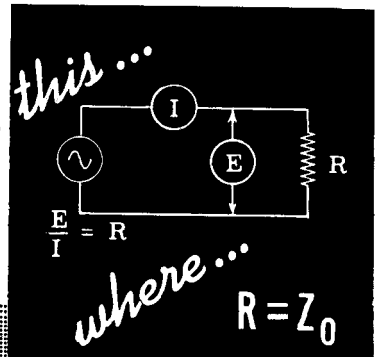

*where ...*

## TRANSMISSION LINES

### Line Termination In Characteristic Impedance

If a transmission line is terminated in a resistive load equal to its characteristic impedance, the load will absorb all the energy from the line that is applied to the input by the generator. This is the ideal condition of maximum power transfer.

### ... FOR MAXIMUM POWER OUTPUT

$$Z_{\text{LOAD}} = Z_0$$

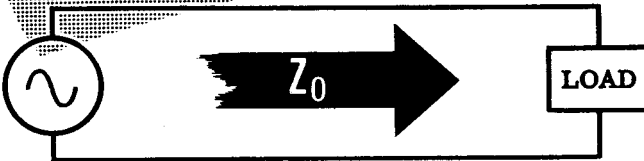

An example of getting maximum power transfer from a transmission line to a load is the case of a line feeding an antenna. If a certain type of antenna, called a "half-wave dipole," is used, the impedance at its center feed point is 73 ohms. Therefore in order to get maximum power transfer from the transmission line to the antenna, the characteristic impedance of the line should be 73 ohms or close to it. When this is the case, the line is said to be "matched" to the antenna.

### ... MATCHING LINE TO ANTENNA

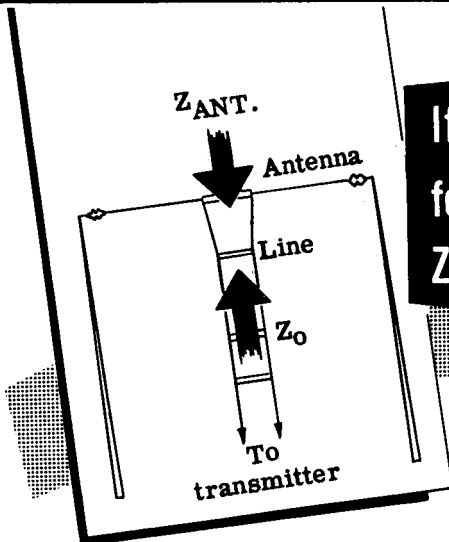

If ...  $Z_{\text{ANT.}} = 73 \Omega$  ...

for *Maximum Power Output*

$Z_0$  should equal  $73 \Omega$



## TRANSMISSION LINES

### Nonresonant and Resonant Lines

When a transmission line is matched to a load ( $Z_{load} = Z_0$ ), the AC voltage measured across the line at any point is the same, discounting the slight voltage drops in the line due to its resistance. The current measured at any point in the line is also the same. This condition is shown in the illustration by equal readings on the RF voltmeters and ammeters placed along the length of the line. The effective voltage and current distribution along the line can be shown graphically by two straight lines indicating that the effective RF voltages and currents are equal all along the length of line. Such a line is called a "flat" line or nonresonant line. A transmission line will always be nonresonant if it is terminated in its characteristic impedance, which is the condition required for maximum power transfer.

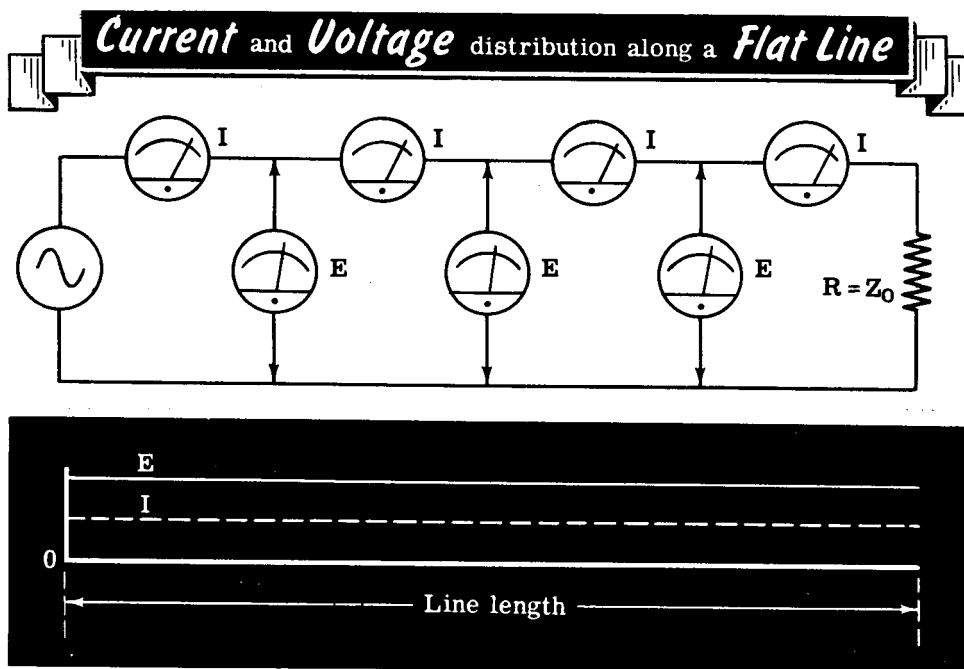

If a line is not terminated in its characteristic impedance it is said to be "mismatched," and all of the RF energy traveling down the line is not absorbed at the load end. The amount of energy absorbed depends upon how close the value of the load impedance is to the characteristic impedance of the line. Since the load of a mismatched line does not absorb all of the energy coming down the line, part of the energy which is not absorbed must be reflected back up the line. This energy which is reflected is called the "reflected wave." A mismatched line therefore has two waves flowing through it, the forward wave and the reflected wave. These two waves combine all along the line (now called a "resonant line") to form a resultant wave called a "standing wave."

## TRANSMISSION LINES

### Standing Waves on a Rope

To better understand how energy travels down a transmission line and how reflections generate standing waves on the line, consider a rope when one end is fastened to a wall while the other end is held in the hand. When the hand flicks the rope once, a vibration starts to travel down the rope. If the rope were infinitely long, the vibration would continue down the rope forever. This is equivalent to an infinite length of transmission line or a flat line in that the energy put into the line is completely absorbed.

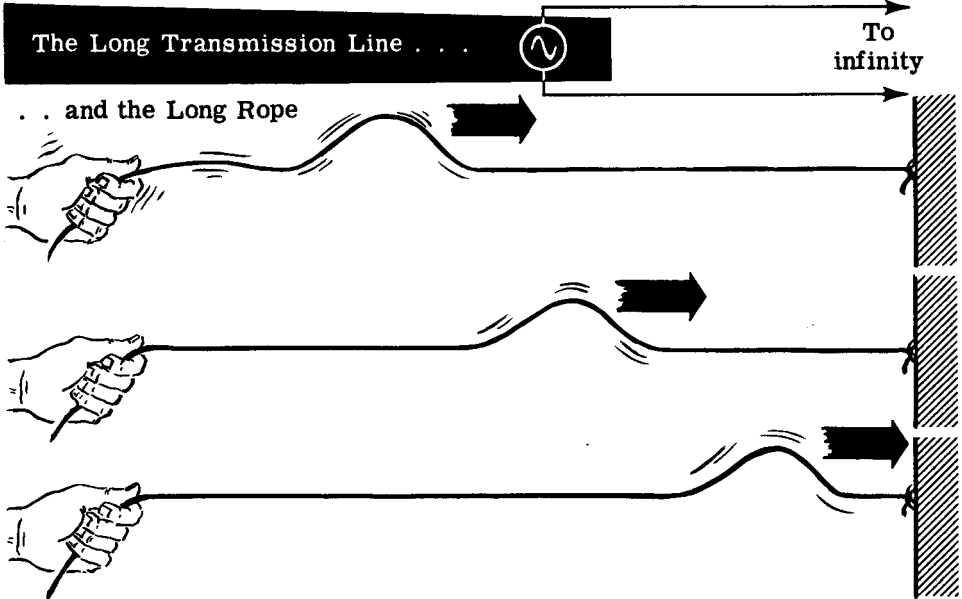

When the vibration traveling down the rope reaches the end attached to the wall, it is reflected back toward the hand. Similarly when a transmission line is mismatched, the electrical energy is reflected back toward the generator. If the hand vibrates the rope at a constant rate, the reflected vibrations combine with the oncoming vibrations to produce standing waves along the rope. At some points along the rope, the forward and reflected vibrations are in phase, reinforcing each other to produce vibration of large amplitude. At other points they are out of phase, thereby cancelling each other, and the rope appears to be motionless at these points. In a similar manner standing waves of voltage and current are formed on a transmission line when it is mismatched.

### STANDING WAVES on a rope

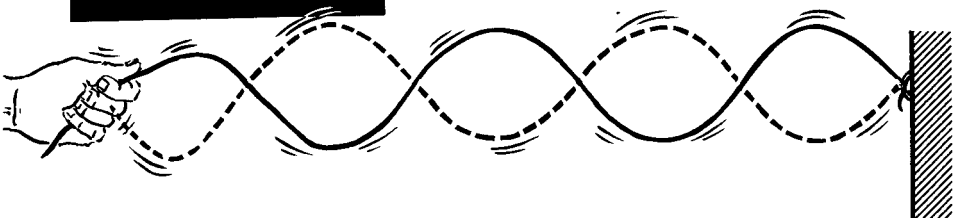

## TRANSMISSION LINES

### Open and Shorted Transmission Lines

When a transmission line is open at its end, the forward and reflected waves combine along the line to form points of varying effective voltage and current. At the open end, the effective voltage is a maximum and the effective current is zero. It is easy to see that the current must be zero at all times at the open end because it is an open circuit. Also since charges build up on the open ends, a large voltage difference will exist there. At half-wavelength distances from the open end, the voltage and current conditions will repeat themselves, and between these half-wave points the effective voltage and current readings will vary as a sine wave varies. The meter reading in the illustration shows the variations in the effective voltage and current along the length of the line at quarter-wavelength distances from the open end to the input. The wave forms shown are actually a plot of these voltage and current readings at different points along the line. The wave forms are called "standing waves." Observe that the standing waves cause the voltage and current to be zero at all times at certain definite points along the line. Notice that when the current is zero, the voltage is a maximum and when the voltage is zero, the current is maximum.

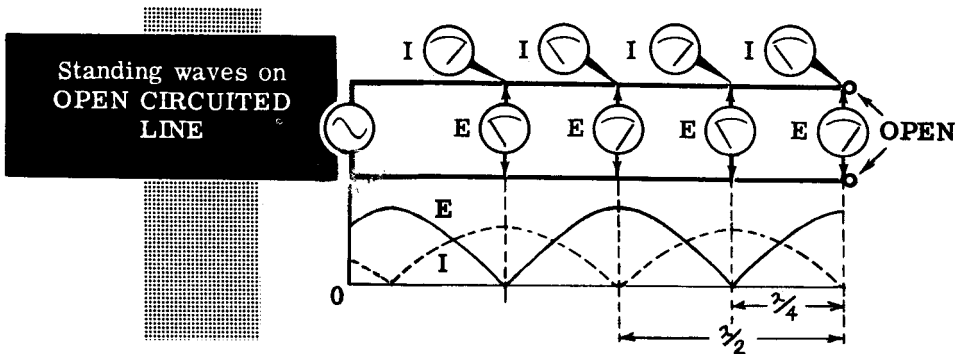

When the transmission line is shorted at its terminating end, the voltage at the open end must be zero because no voltage can exist across a short. Also the current at the short will be a maximum because the short provides a zero resistance path through which current can flow. Just as in the open-circuited line, these voltage and current conditions at the terminating end will repeat themselves at one-half wavelengths back from the short circuit. Observe that the standing waves on the short-circuited line have been displaced a distance equivalent to a quarter of a wavelength (90 degrees) compared to waves on the open-circuited line.

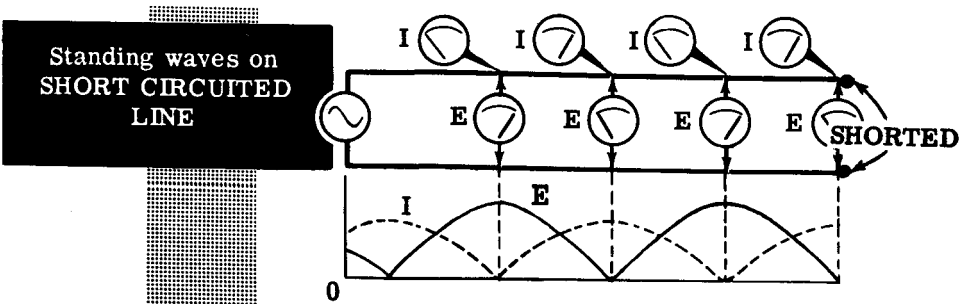

## TRANSMISSION LINES

### Input Impedance of a Line

In a transmission line terminated in its characteristic impedance, the voltage and current readings are the same all along the line. Therefore, the impedance anywhere along the line is constant and equal to its characteristic impedance. In other words, if you were to break off the line anywhere along its length and measure the impedance ( $Z_{in}$ ) looking in towards the load end, the impedance value measured would always be the same and equal to the characteristic impedance,  $Z_0$ , which is resistive.

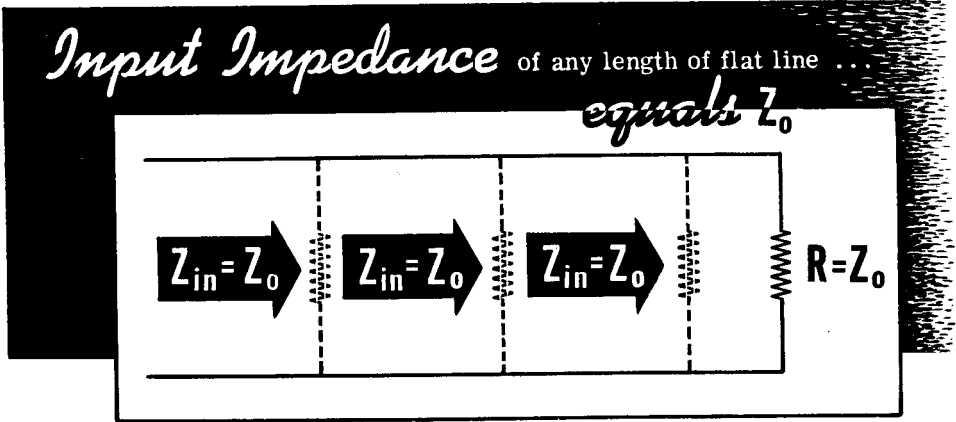

When a transmission line is terminated in other than its characteristic impedance, it becomes resonant and develops standing waves. The input impedance then varies with the length of the line because the effective values of the current and voltage vary along the length of the line. Also the reactance of the input impedance varies, being sometimes resistive, sometimes capacitive and sometimes inductive. Therefore, a resonant line has the characteristics of a resonant circuit which presents a resistive load at the resonant frequency and an inductive or capacitive reactance on either side of the resonant frequency.

### *Input Impedance* OF A RESONANT LINE

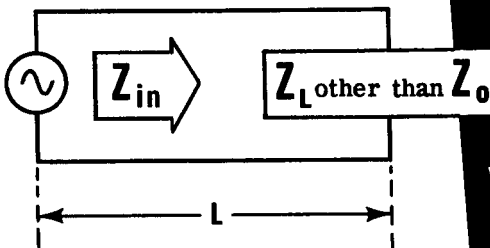

Depending on length of line ( $L$ ),  $Z_{in}$  is sometimes.....



## TRANSMISSION LINES

### Input Impedance of Short-Circuited Line

A short-circuited line appears as a very low resistance at the shorted end, since the voltage is minimum and the current is maximum. This low resistance is repeated every half wavelength back from the shorted end. Since the line is called "resonant," it is convenient to think of the low resistance points along the line as series-resonant circuits. For example, the input impedance at a half-wavelength section of shorted line is that of a series-resonant circuit. A quarter wavelength back from the shorted end, the current is minimum and the voltage is maximum. Therefore, this is a point of high resistance. This high resistance point is repeated every half wavelength back from the first high resistance point. The high resistance points can be considered to be parallel-resonant circuits just as the low resistance points are series-resonant circuits.

Between the high and low resistance points, the input impedance is either a capacitive reactance or an inductive reactance. From zero to a quarter wavelength back from the terminating short circuit, the input impedance is inductive. The inductive reactance is low in the vicinity of the short circuit and increases in magnitude as you approach the quarter-wave point. Exactly at the quarter-wave point, the impedance is a pure high resistance.

Between a quarter wavelength and a half wavelength, the input impedance is capacitive reactance. The capacitive reactance decreases as the half-wavelength point is approached until, at the half-wavelength point, the impedance is a pure low resistance.

The type and magnitude of the input impedance as seen at different points along the short-circuited line is illustrated below.

### INPUT IMPEDANCE ALONG A SHORT CIRCUITED LINE

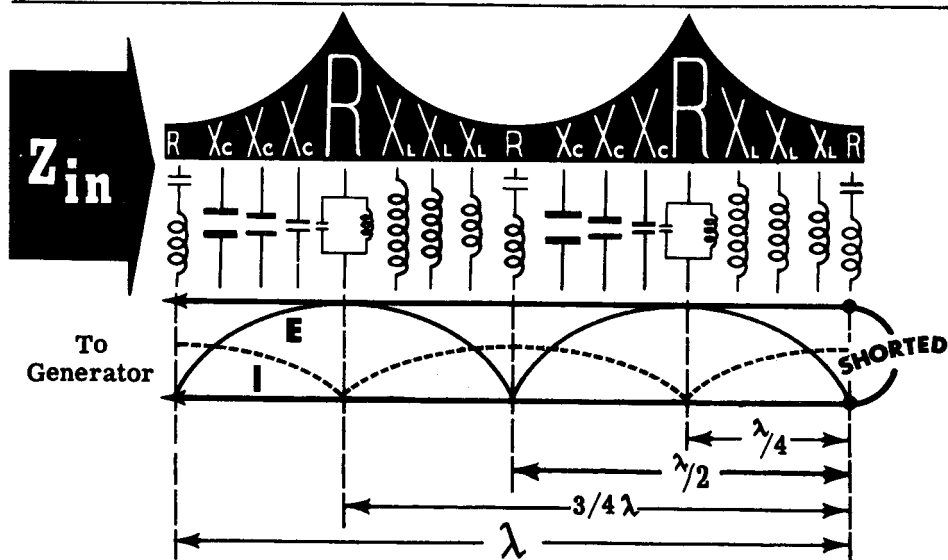

## TRANSMISSION LINES

### Input Impedance of Open-Circuited Line

In the open-circuited line, the terminating impedance (open circuit) is a high resistance and therefore acts like a parallel circuit. A quarter wavelength back the input impedance is a low resistance and therefore has the characteristics of a series-resonant circuit. Between zero and one-quarter wavelength back from the open circuit, the input impedance is capacitive, and between one-quarter and one-half wavelength the input impedance is inductive. If you compare the open- and short-circuited lines, you will observe that for a given wavelength back from the end, the reactances are opposite to each other; where one is capacitive the other is inductive and vice versa.

### INPUT IMPEDANCE ALONG AN OPEN-CIRCUITED LINE

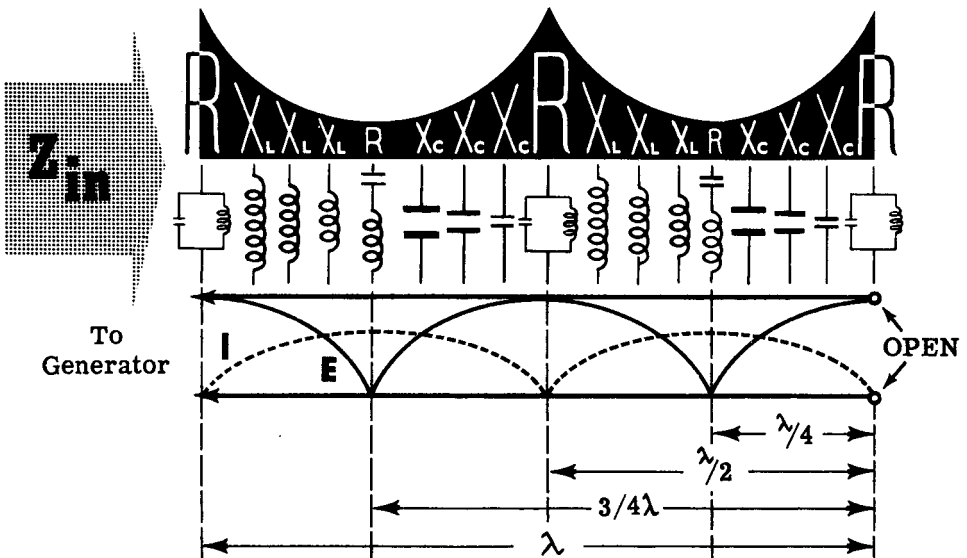

The following diagrams illustrate different lengths of open and shorted lines and the input impedance they present to a generator.

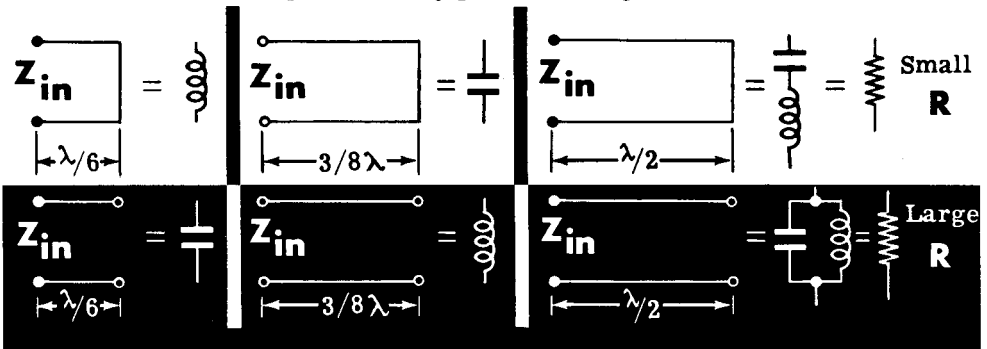

It is obvious from the above diagrams that the terminal conditions at the end of the line are the only factors which determine the type and magnitude of the input impedance at any point along the line.

## TRANSMISSION LINES

### Frequency Measurement Using Standing Waves

Whenever standing waves exist on a transmission line, the adjacent peaks of voltage are always one-half wavelength apart as are the adjacent peaks of current. Similarly, adjacent zero points of voltage and current are also one-half wavelength apart. If the distance between two adjacent peaks of either voltage or current can be determined, the frequency of the RF can be calculated using the formula: frequency (in megacycles) =  $\frac{5906}{D}$ , where "D" is the measured distance in inches between adjacent peaks.

A standard procedure for determining the high frequency oscillations of an oscillator is to use a Lecher wire setup. A pilot lamp is coupled to the oscillator tank circuit until it glows. Then a short is placed across the open terminals of the Lecher wire and moved slowly back toward the oscillator until a point on the line is reached where the short reflects a short across the input to the line loading down the oscillator tank circuit. The oscillator does not generate as much power as before and the bulb's brightness dims. As the short continues to move down the line, the reflected short at the oscillator output disappears and the bulb comes back to its original brightness. Soon another point is reached where the short reflects a short across the oscillator output and again the bulb flickers. The number 5906 divided by the distance, in inches, between these two points gives the frequency of oscillations in megacycles.

$$F(\text{mc}) = \frac{5906}{D(\text{in})}$$

### MEASURING OSCILLATOR FREQUENCY USING STANDING WAVES

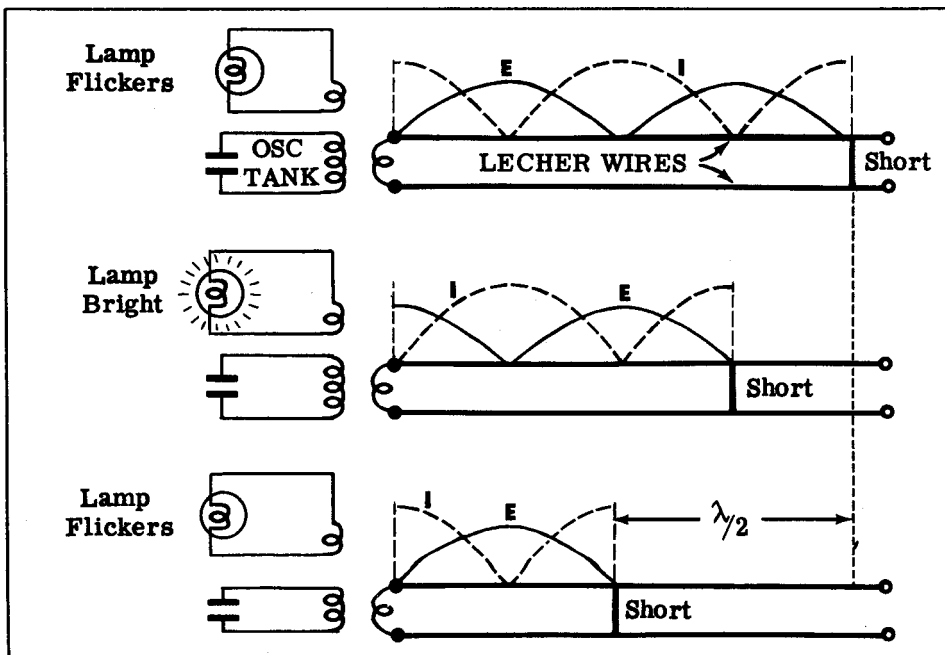

# TRANSMISSION LINES

## Applications of Transmission Line Principles

With your understanding of how transmission lines work, suppose you learn about a few of the many applications of transmission lines in electronic equipment.

A shorted quarter-wave transmission line, known as a "stub," will offer a very high impedance at its input. It can therefore be used as a metallic insulator to support a two-wire transmission line without shorting the line.

### $\lambda/4$ STUB USED AS A METALLIC INSULATOR

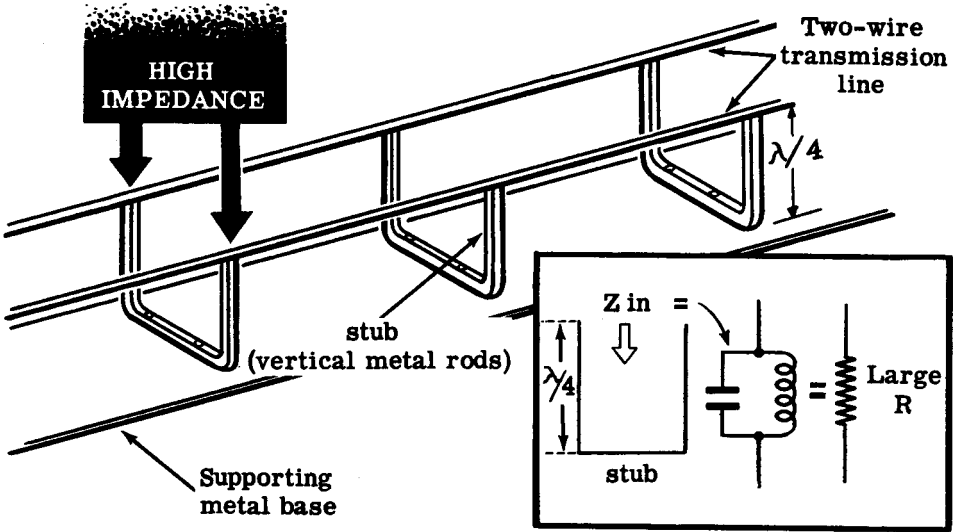

The shorted quarter-wave stub also makes a very effective filter for harmonic frequencies of the fundamental which one does not desire to transmit. For the fundamental frequency the stub is a high impedance as was shown above. For the second harmonic, the stub is now a half wavelength long and will act as a short circuit across the transmission line, shorting out the undesirable harmonic and preventing it from getting to the antenna.

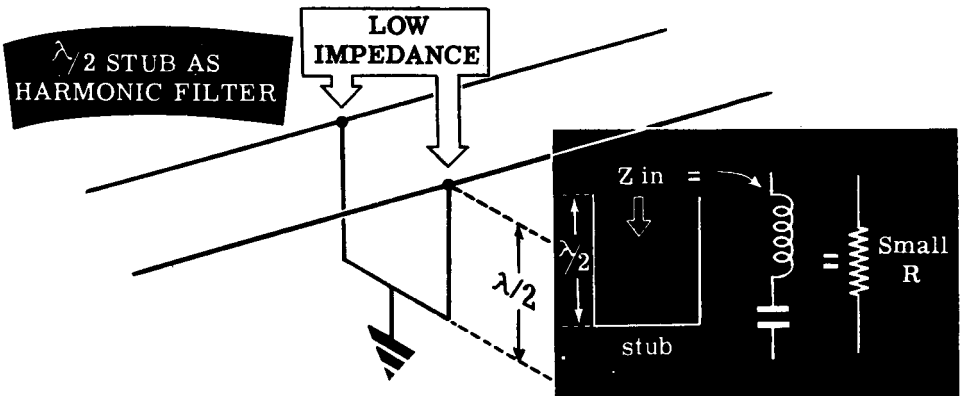



## TRANSMISSION LINES

### Applications of Transmission Line Principles (continued)

An important application of a short transmission line, or "tuned line section," as it is called, is to tune out the reactance of a load on a transmission line thus leaving the load resistive.

For example, suppose a 300-ohm line is feeding a load which looks like a 300-ohm resistance in parallel with a capacity. Since the load is not completely resistive, standing waves will exist on the line and maximum power transfer to the load will not be realized. If an inductance could be placed in parallel with the capacity, to effect a parallel-resonant circuit, the transmission line would look into the 300-ohm resistive component in parallel with the high resistance of the parallel-resonant circuit. Since the high resistance of the parallel-resonant circuit is so much greater than 300 ohms, the transmission line effectively sees only the 300-ohm resistance. The effect of the capacity has thus been cancelled out.

The way to introduce an inductance across the load is to place a quarter-wave shorted stub, with a movable shorting arm, across the load terminals. By moving the short so that the stub is less than a quarter wavelength long, the input reactance of the stub becomes inductive. The value of this inductance can be varied by means of the movable short until it cancels the capacity of the load, leaving the load resistive.

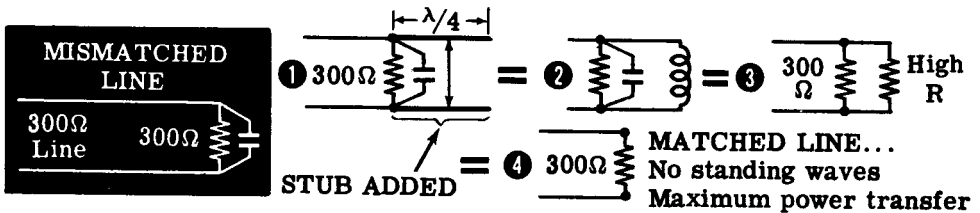

Quarter-wavelength sections are also used as transformers or matching devices to connect circuits of unequal impedances. If a low impedance input circuit is to be connected to a high impedance grid circuit, the input circuit may be tapped down on the coil of a tank circuit as shown. If a tuned line is used, the input circuit can similarly be tapped down on the tuned line. This is an example of a tuned line used as a step-up transformer.

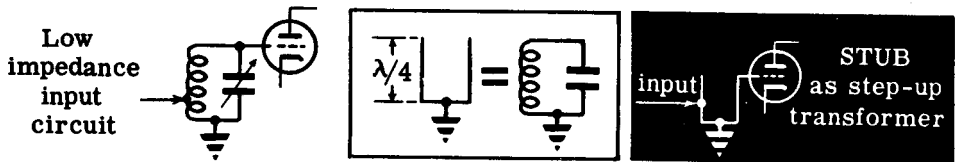

A quarter-wave stub can be used as a step-down transformer to match a high impedance line to a low impedance dipole antenna. The line is connected to the high impedance input of the stub and the antenna is connected near the low impedance shorted end of the stub.

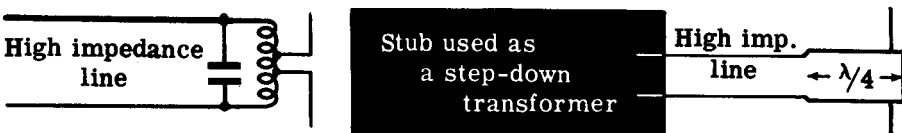

# TRANSMISSION LINES

## Types of Transmission Lines

Many different types of transmission lines are employed in electronic applications. Each line has a certain characteristic impedance, current carrying capacity, insulation and physical shape to meet a particular requirement. Below are shown some of the most frequently used transmission lines.

A simple method of feeding an antenna from a transmitter is to use a single-wire transmission line with the ground return completing the circuit.

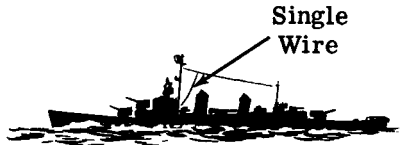

Another type of transmission line consists of two parallel wires which are maintained at a fixed distance from each other by insulated spacers. Since the line is not shielded, losses occur, due to radiation and absorption by metallic objects. The use of the line is therefore restricted to comparatively low-frequency transmission and it should be strung only in places where it will be away from metallic objects and out in the open.

### TWO WIRE OPEN LINE

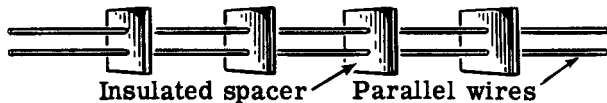

Some of the disadvantages of the two-wire open line are overcome in the concentric line which is made of a cylindrical copper tube with a thin conductor running full length through the center. The inner conductor is kept centered by spacers and the outer conductor is grounded to shield the inner conductor. Since the line is mechanically rigid, it can be used only for permanent installations.

### CONCENTRIC LINE



The inflexibility of the concentric line is overcome in the coaxial cable which consists of one or more inner conductors imbedded in an insulating material and covered with a grounded copper braid. The coaxial cable has much higher losses than the concentric line.

### COAXIAL CABLE



At very high frequencies the losses in any of the above mentioned lines become excessive and wave guides must be used. Wave guides are made of round or rectangular hollow tubes.

### WAVE GUIDE



## TRANSMISSION LINES

### Demonstration—Transmission Lines

In this demonstration a high-frequency oscillator is going to feed Lecher wires on which standing waves will be generated. The presence of these standing waves will be shown with different types of pickup devices. You will also see that the current and voltage peaks are shifted a half wavelength when the end of the line is shorted. A procedure for determining the frequency output of an oscillator using Lecher wires will be demonstrated as will a method for determining the characteristic impedance of a transmission line.

The transmitter used for this demonstration is a very high frequency tuned-line oscillator which will oscillate in the neighborhood of 160 megacycles. The oscillator is effectively a Colpitts oscillator with the tuned line acting as the coil of the tank circuit and the tube interelectrode capacities acting as the capacitor voltage divider network. The schematic and equivalent RF circuit of the oscillator are pictured below. The capacities represented in the equivalent circuit are the interelectrode capacities, and the inductance  $L$  is the input reactance of the less-than-a-quarter-wavelength short-circuited transmission line. The oscillator will always oscillate at the frequency for which the tuned line is less than a quarter-wavelength long. One of the pickup devices is an RF current meter whose circuit diagram appears below.

---

### Schematic

---

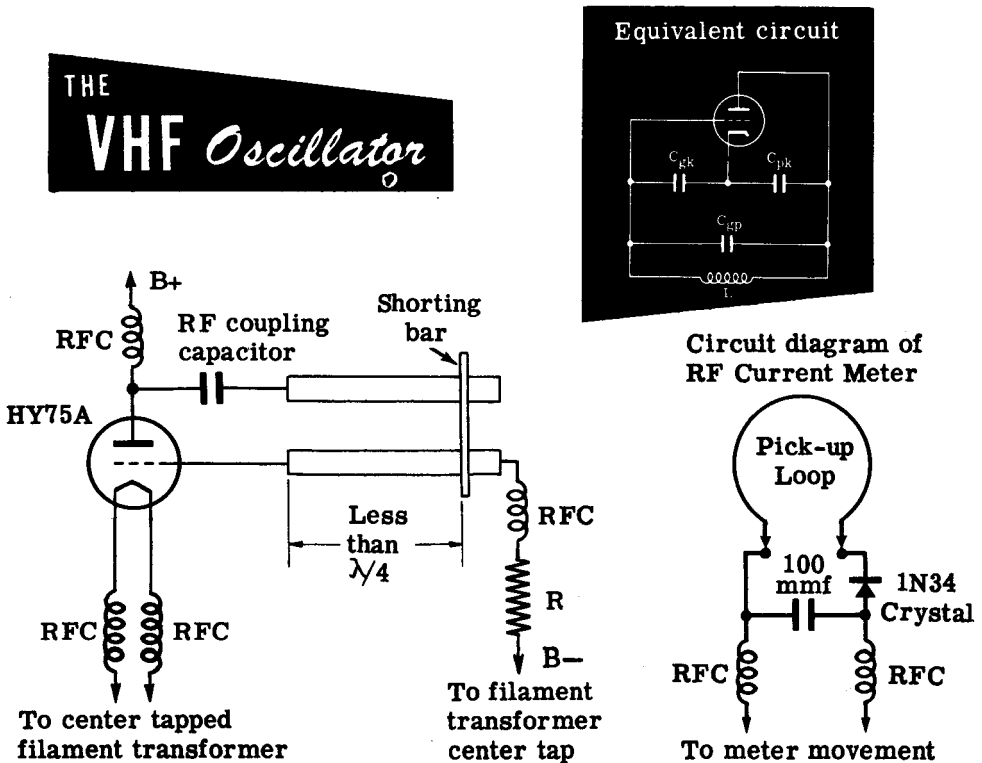

## TRANSMISSION LINES

### Demonstration—Transmission Lines (continued)

Next the instructor demonstrates the existence of standing waves along the open-ended Lecher wires, using various indicating devices.

The high frequency oscillator is turned on, and the Lecher wires are energized. The meter-type RF current indicator is moved underneath the wires, and the distance of the loop from the wires is adjusted so that the meter shows a maximum deflection. Then the meter is moved slowly along the length of the wire and the position of the maximum current points are noted. The distance between two adjacent current peaks is equal to one-half wavelength.

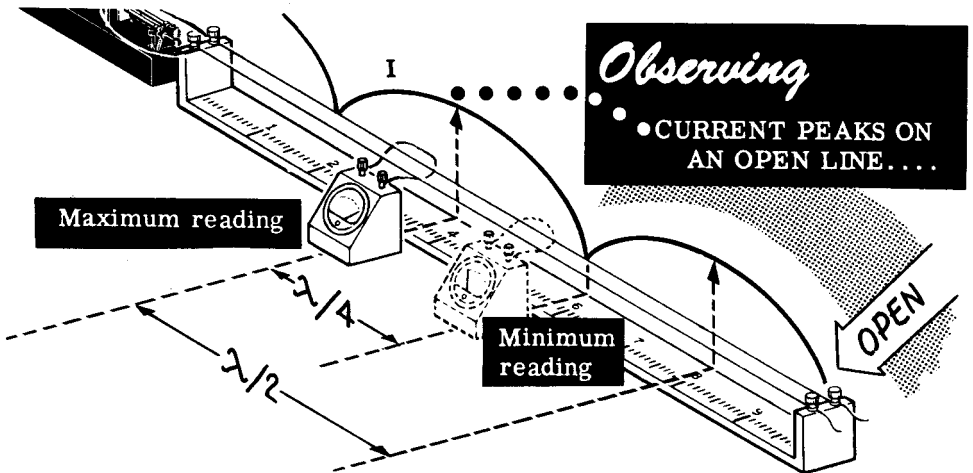

The meter indicator is placed at a point of maximum current, and the instructor shorts the open end of the line with a screwdriver. The reading drops immediately and the meter is moved to the new current peak which is a quarter wavelength away from the previous current peak position. The short has displaced the standing waves one-quarter wavelength from their position when the line was open. The short is removed and the demonstration continues.

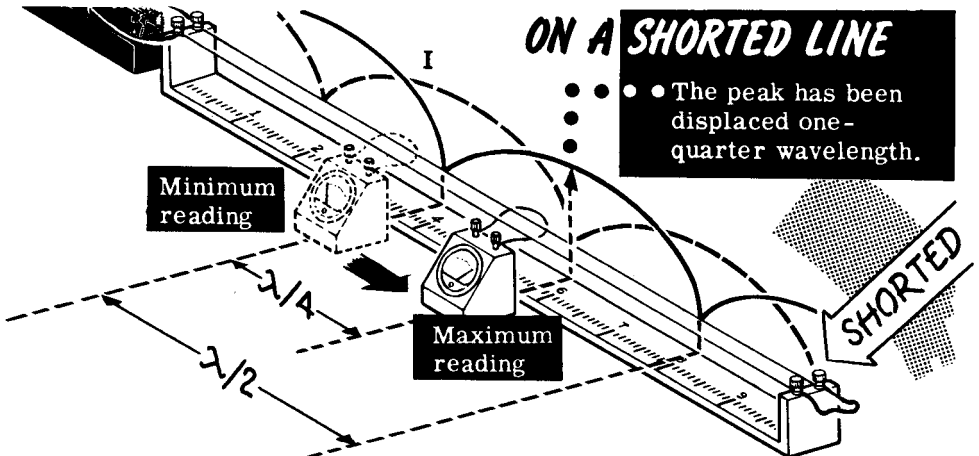

## TRANSMISSION LINES

### Demonstration—Transmission Lines (continued)

The position of current peaks can also be shown using a pilot light indicator. The pilot indicator is placed across the open-ended Lecher wires and slowly moved along their entire length. When a current peak is reached, the bulb lights. Observe that the bulb lights at the same point where the current meter had indicated current peaks.

### USING *PILOT LIGHT* TO INDICATE *CURRENT* PEAKS

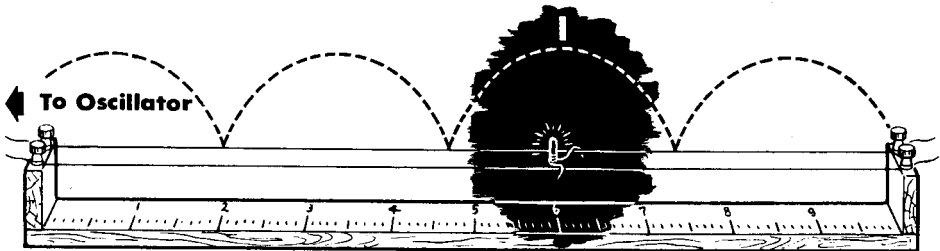

The voltage peaks can be found by using a neon bulb. The instructor holds the glass end of the bulb with his fingers and moves it along one wire, keeping a wire from the bulb in contact with the line at all times. The bulb remains out at the current peaks previously noted, but lights up between the current peaks, reaching maximum brilliance equidistant between two current peaks. The point of maximum brilliance is a voltage peak.

### USING *NEON BULB* TO INDICATE *VOLTAGE* PEAKS

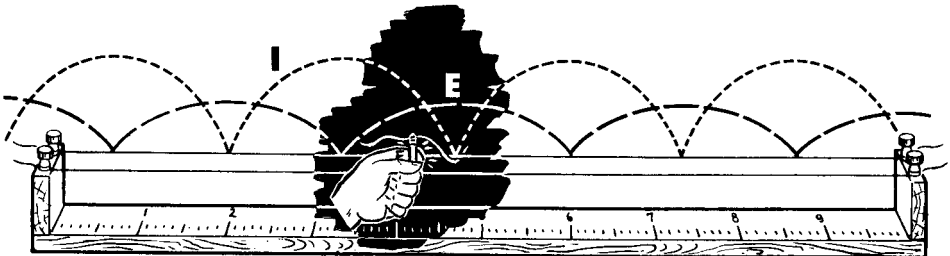

Both voltage and current peaks can be shown by using a long fluorescent light. The light areas are voltage peaks or current nulls.

### OBSERVING STANDING WAVES USING A *FLUORESCENT LIGHT*

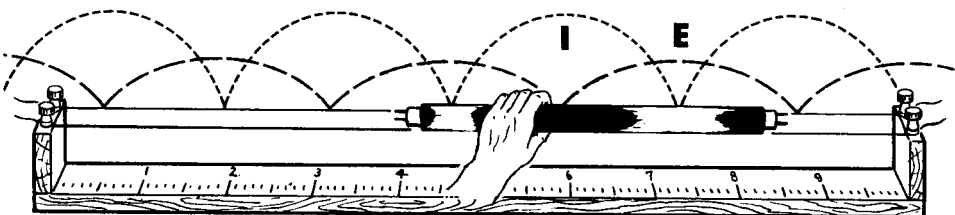

## TRANSMISSION LINES

### Demonstration—Transmission Lines (continued)

When a transmission line is terminated in its characteristic impedance, no standing waves of voltage or current will exist on the line. Therefore the characteristic impedance of a line can be determined by placing different values of resistance across the line until the standing waves disappear or are reduced to a minimum. The value of the resistor which produces this result is equal to the line characteristic impedance.

The instructor turns on the high frequency oscillator and checks for standing waves on the line using the meter-type RF current indicator. As the meter indicator is moved along the line, the readings vary from a maximum to a minimum indicating the presence of standing waves. Next, each of the resistors in turn is connected across the line, and a check is made each time for the presence of standing waves. When the current indicator gives a practically constant reading along the entire length of the line, the value of the resistor connected across the end of the line is approximately equal to the line characteristic impedance.

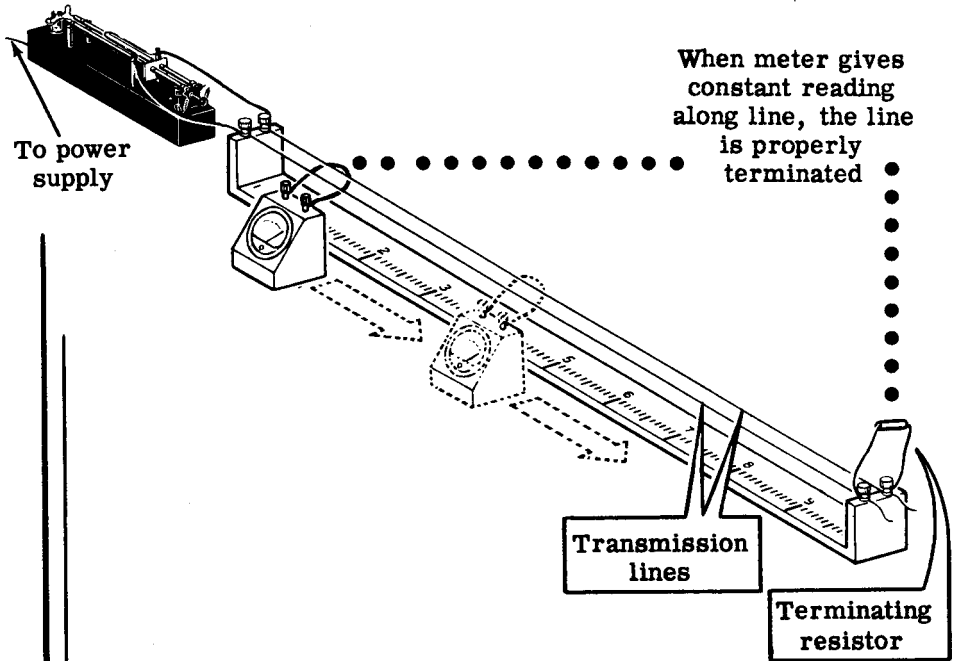

Determining Characteristic Impedance of a Line

## TRANSMISSION LINES

### Demonstration—Transmission Lines (continued)

The instructor now demonstrates a procedure for determining the frequency of a high frequency oscillator using Lecher wires.

The pilot light and pickup loop are coupled to the oscillator tank circuit by placing the coil between the tuned line and the tuning rod so that the bulb lights. Then, holding a screwdriver by the insulated handle and with the metal shank at the input end, the instructor shorts out the line, and slowly moves the screwdriver toward the open end, keeping the line shorted. At a certain point the pilot light dims, indicating that the short is electrically a half wavelength away from the coupling loop and therefore is loading down the oscillator. This point is carefully noted and the instructor continues to move the screwdriver toward the open end. Again a point is reached when the light dims. This point is one-half wavelength away from the preceding point. The instructor using the formula  $F = \frac{5906}{D}$  (where  $F$  is the frequency in megacycles and  $D$  is the distance in inches between the two points) calculates the oscillator frequency.

If the meter-type RF current indicator is used in place of the bulb, the correctly positioned shorted points will show up as a dip reading on the meter.

### Determining Oscillator Frequency

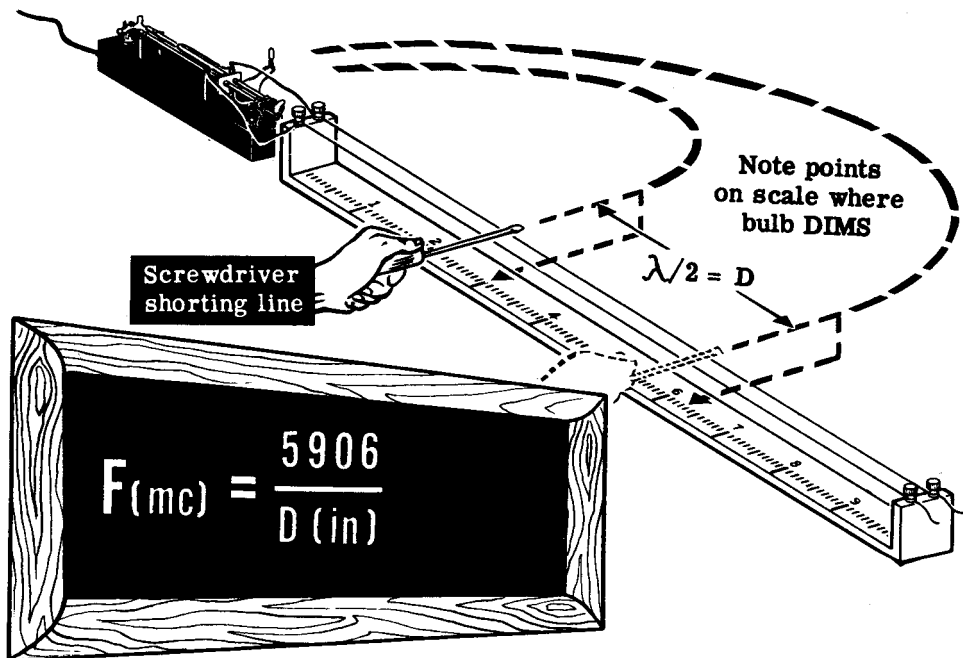

# TRANSMISSION LINES

## Review

**TRANSMISSION LINES** — The purpose of a transmission line in a transmitter is to convey RF energy from the transmitter to the antenna. The characteristic impedance of the transmission line should match the input impedance of the antenna, if maximum power transfer to the antenna and therefore maximum radiated power is to be realized.

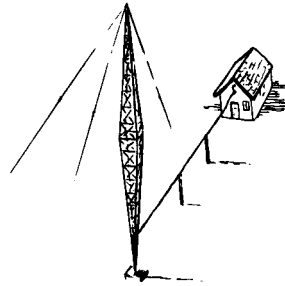

**CHARACTERISTIC IMPEDANCE** — A transmission line has a characteristic impedance ( $Z_0$ ). If it is terminated in a load equal to its characteristic impedance, maximum power is transferred to the load and no standing waves exist on the line.

## ... MATCHING LINE TO ANTENNA

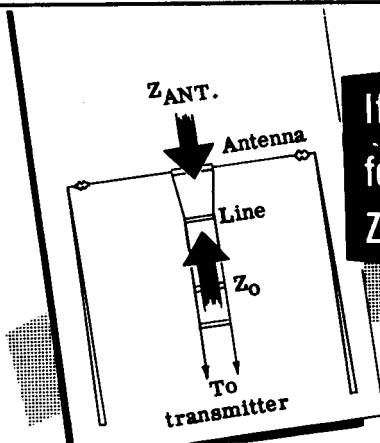

If ...  $Z_{ANT.} = 73 \Omega$  ...

for Maximum Power Output  
 $Z_0$  should equal  $73 \Omega$

**STANDING WAVES** — When a transmission line is terminated in a load other than its characteristic impedance, some of the energy is reflected at the end of the line back towards the generator. The forward and reflected waves combine along the line to form standing waves. The voltage and current distribution along an open and shorted line are as shown.

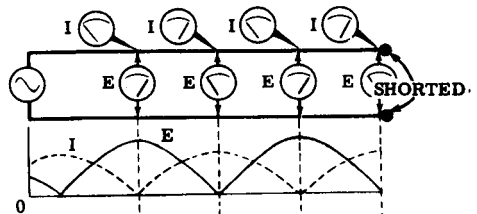
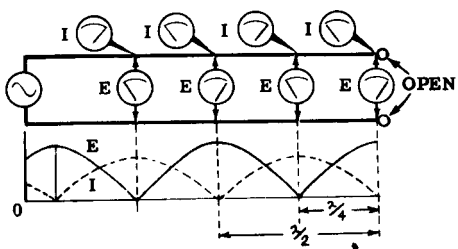



# ANTENNAS

## Purpose of an Antenna

The purpose of a transmitting antenna is to convert the power delivered by the transmission line into a wave called an "electromagnetic wave." This electromagnetic wave has the unique property of radiating through space without the aid of wires. All antennas work on the same principle—the antenna current generates an electromagnetic field which leaves the antenna and radiates outward as an electromagnetic wave.

The antennas you will be concerned with now are those which are designed as transmitting antennas. These will operate at much higher frequencies than the power lines and will be much more efficient. However, it is still the current which flows in the antenna that causes the electromagnetic field to be radiated.

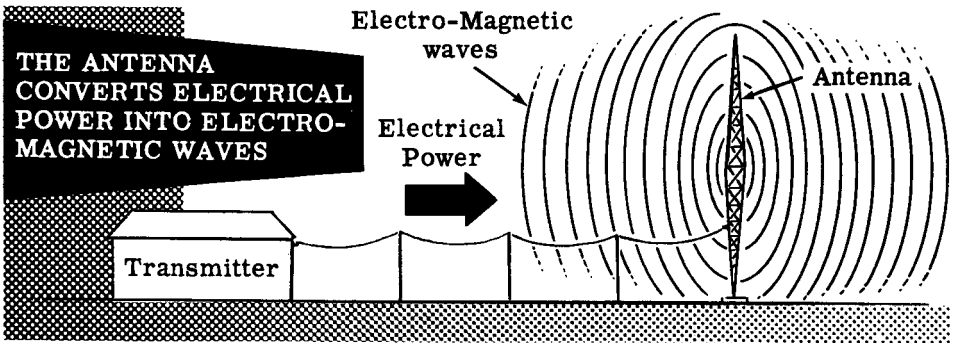

An interesting example of antenna action can be observed by touching your finger to the vertical input terminal of an oscilloscope. You will see a 60 cycle wave form on the 'scope screen which obviously must come from your body. What is actually happening is that your body is picking up 60 cycle electromagnetic waves which are radiated from the many power wires that carry 60 cycle current. The power lines are acting as transmitting antennas although they were not designed for that purpose.

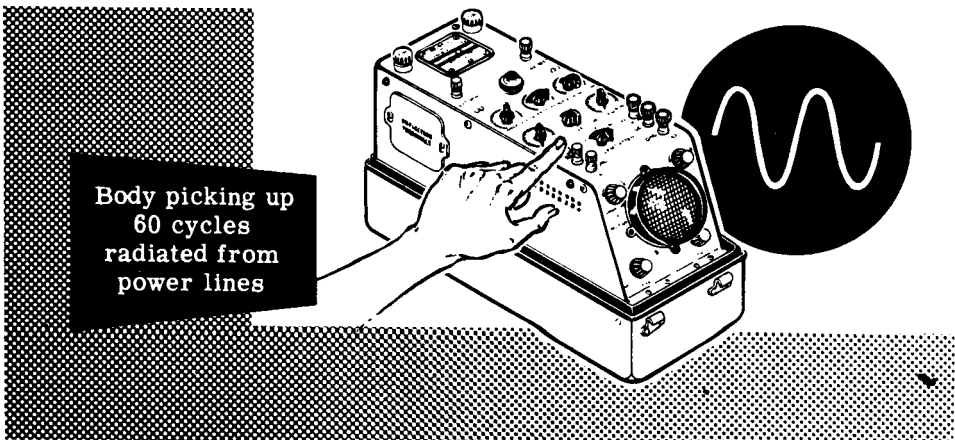

# ANTENNAS

## How an Antenna Works

If the wires of an open-ended transmission line are bent back a quarter wavelength from the open end, at right angles to the line, a simple antenna is formed called a half-wave dipole, a "doublet" or a "Hertz antenna."

The voltage and current distribution on the antenna are the same as on the original transmission line.

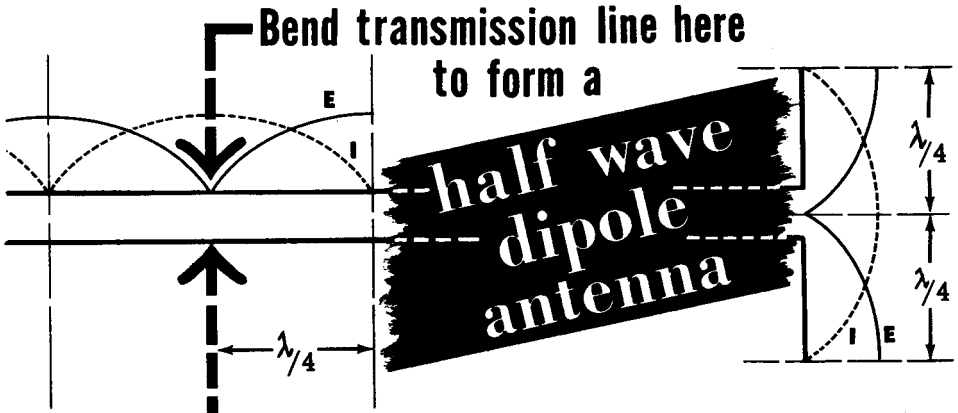

Although the voltages at any two points on the antenna wires (also on the transmission line), equidistant from the ends, are equal in amplitude, they are opposite in polarity just as the ends of a transformer winding are equal in amplitude but opposite in polarity. The same holds true for current. Therefore, to indicate polarity as well as amplitude on the wires that comprise the transmission line and antenna, the wave forms are redrawn as shown.

## WAVE FORMS SHOWING POLARITY AND AMPLITUDE

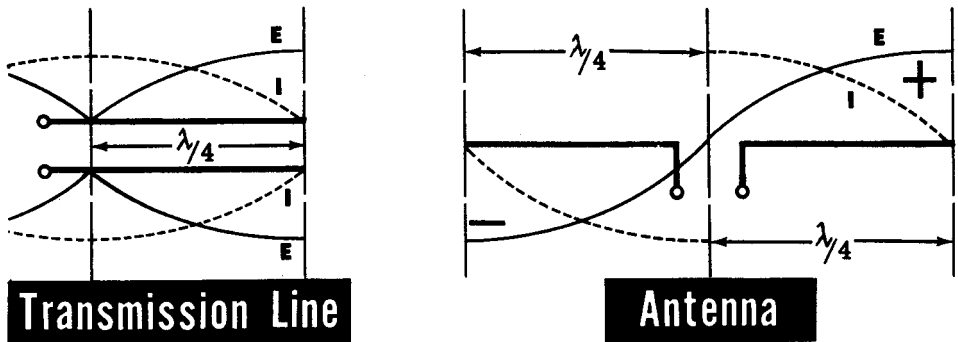

Observe that the standing waves of voltage and current indicate that the antenna ends are points of maximum voltage and minimum current, whereas the center of the antenna is a point of maximum current and minimum voltage.

## ANTENNAS

### How an Antenna Works (continued)

Whenever there is a difference of voltage between two points, an electric field is set up between these points. You learned in Basic Electricity that when a capacitor is charged, one plate will be positive and the other negative. As a result, an electric field having a direction toward the positively charged plate is built up between the capacitor plates as shown. Similarly, the voltage difference between the two wires of an antenna also generates an electric field having a pattern and direction as shown below.

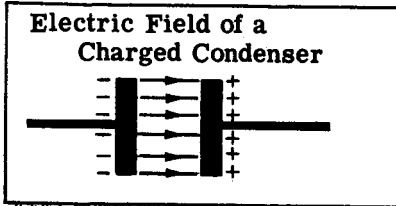

### Electric Field Surrounding an Antenna

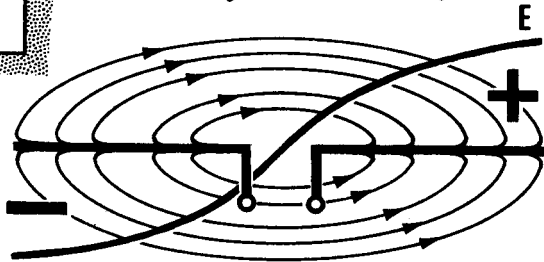

Besides this electric field, there is also a magnetic field which is generated by the antenna current. The plane of this magnetic field is at right angles to the direction of the current flow and therefore is at right angles to the antenna, as shown. The electric and magnetic fields must therefore be at right angles to each other.

### Magnetic Field Surrounding an Antenna

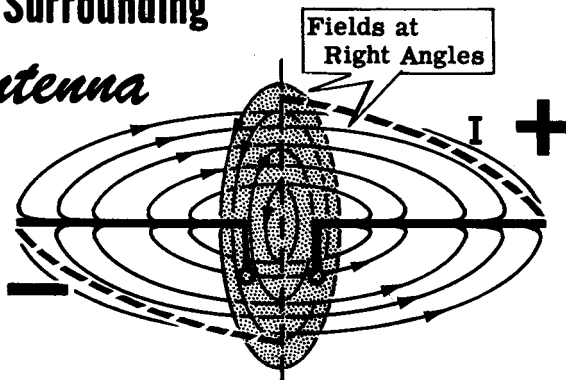

These electric and magnetic fields alternate about the antenna, building up, reaching a peak, collapsing, and building up again in the opposite direction, at the same frequency as the antenna current. In the process of building up and collapsing, a portion of these fields escape from the antenna and become the electromagnetic waves which radiate through space conveying the transmitted intelligence to distant receivers.

# ANTENNAS

## Basic Antennas

The half-wave dipole or Hertz antenna is one type of basic antenna which finds wide application in many types of transmitting and receiving equipment.

Another basic antenna is a vertical quarter-wave grounded antenna sometimes called a "Marconi antenna". If one of the elements of a Hertz antenna is removed and the wire that went to that element is grounded, the result is a Marconi antenna. The earth actually takes the place of one of the quarter-wave elements so that the earth and the remaining quarter-wave element form an effective half-wave dipole. The current maximum and voltage minimum points are at the base of the antenna as shown.

# BASIC ANTENNAS

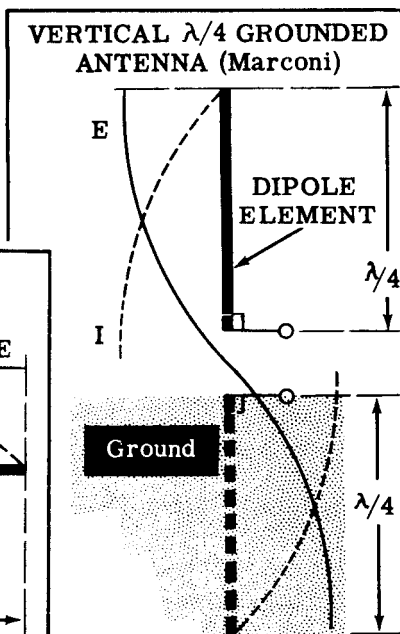
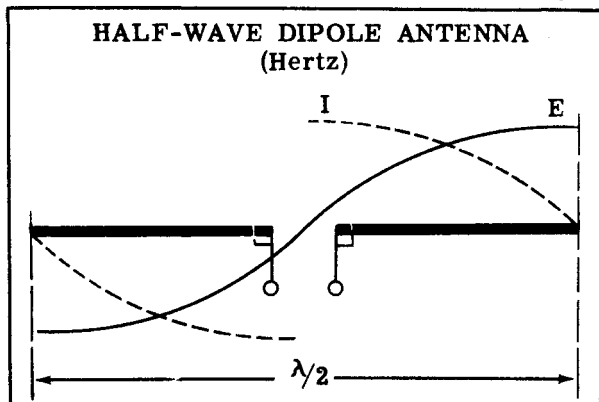

When a Marconi antenna is used, the earth directly beneath the antenna must be a good electrical conductor. Sometimes copper tubing is driven into the ground at the base of the antenna to improve the ground conductivity. On shipboard a vertical quarter-wave antenna may be some distance above the deck. A simulated ground is provided by using grounded metal rods at least a quarter wavelength long and placing them at the base of the antenna. This simulated ground is called a "counterpoise."

Since a quarter-wavelength dipole antenna is physically half as long as a half-wave grounded antenna, it is often preferred at low frequencies (large wavelength) especially when there are space restrictions on antenna mountings. At high frequencies the half-wavelength dipole is extensively used because even though it is longer than the quarter-wave antenna, its overall length will be small, and it can be made of metal tubing which is self-supporting.

# ANTENNAS

## Radiation Resistance

In a half-wave dipole antenna, the voltage at the center is minimum (practically zero) whereas the current is maximum. If you will recall the characteristics of a series-resonant circuit, you will remember that the voltage across it is also minimum and the current through it is maximum. At its center, a half-wave dipole is equivalent to a series-resonant circuit when operated at the proper frequency. A generator that supplies power to a series-resonant circuit works into a pure resistance since  $X_L$  and  $X_C$  cancel each other—the resistance being mainly the wire resistance of the coil.

Similarly, a transmission line works into a pure resistance when a half-wave dipole is connected to it. This resistance consists of both the resistance of the wire and a resistance called the "radiation resistance." The resistance of the wire is negligible, so only the radiation resistance is considered.

## THE INPUT IMPEDANCE OF A DOUBLET LOOKS LIKE...

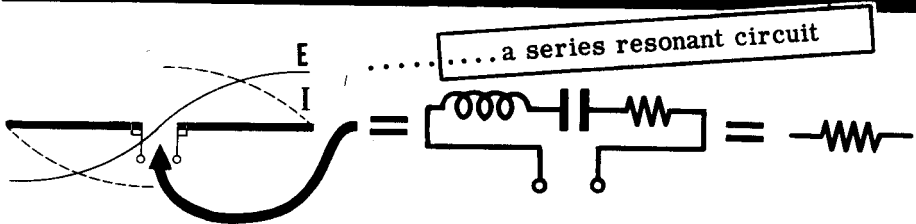

The radiation resistance is not an actual resistance. It is an equivalent resistance which, if connected in place of the antenna, would dissipate the same amount of power as the antenna radiates into space.

The value of the radiation resistance can be determined from the power formula,  $R = \frac{P}{I^2}$ , where P is the power radiated from the antenna and I is

equal to the antenna current at the center of the antenna. For a half-wave dipole the radiation resistance is about 73 ohms, measured at the center of the antenna. This value is fairly constant for different frequency half-wave dipoles.



# ANTENNAS

## Antenna Impedance

Since a half-wave dipole acts like a series-resonant circuit, it will exhibit either inductive or capacitive properties as the RF frequency applied to the antenna is varied.

When the frequency of the RF is just right, the dipole is exactly a half wavelength long and is series-resonant, with its impedance resistive and equal to the radiation resistance. In transmitting it is always desirable that the antenna present a resistive load to the transmission line so that a maximum amount of power will be absorbed by the antenna and radiated.

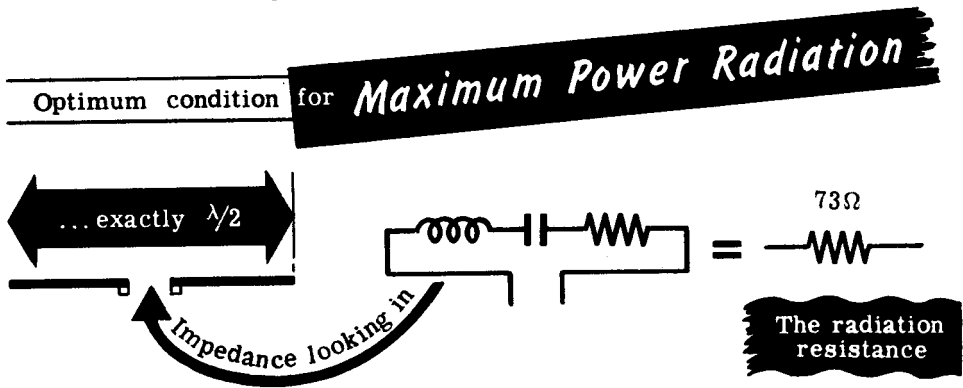

If the frequency of the transmitter goes up, the antenna will be longer than a half wavelength. The series circuit is then operating at a frequency which is above its resonant frequency. At this applied frequency, the inductive reactance is larger than the capacitive reactance and the antenna appears inductive to the transmitter.

Dipole **LONGER** than  $\lambda/2$  appears **INDUCTIVE**

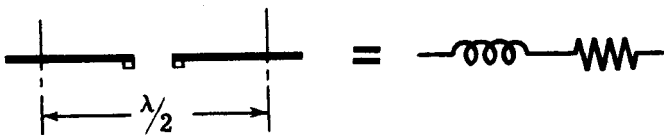

If the frequency of the transmitter goes down, the antenna will be slightly shorter than a half wavelength. The series circuit is then operating at a frequency which is below its resonant frequency. The capacitive reactance is larger than the inductive reactance and the antenna appears capacitive to the transmitter.

Dipole **SHORTER** than  $\lambda/2$  appears **CAPACITIVE**

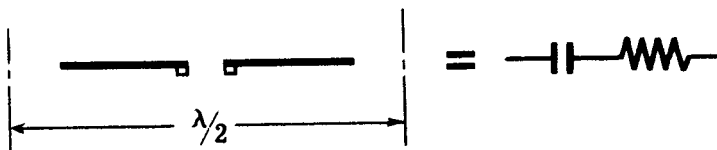

# ANTENNAS

## Tuning the Antenna

You have seen that as the frequency of the transmitter is varied, the electrical length of the antenna varies as does the impedance at its input. Since it is desirable to have the antenna impedance resistive for all transmitter frequencies (for maximum radiated power), the antenna can be resonated by adding inductors or capacitors to effectively increase or shorten its electrical length.

For example, if a vertical quarter-wave grounded antenna is less than a quarter wavelength long, its input impedance at its base will be resistive and capacitive. The antenna can be electrically lengthened (resonated) by adding the right size inductor to cancel the capacity, thus leaving the antenna resistive. The inductor must be placed in series with the antenna at its base as shown.

**TOO SHORT**

### RESONATING A MARCONI ANTENNA

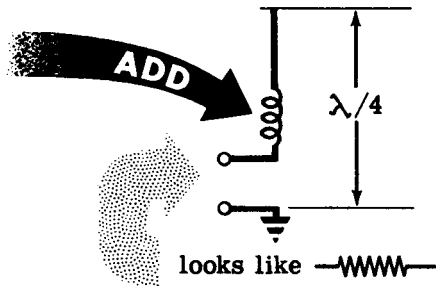
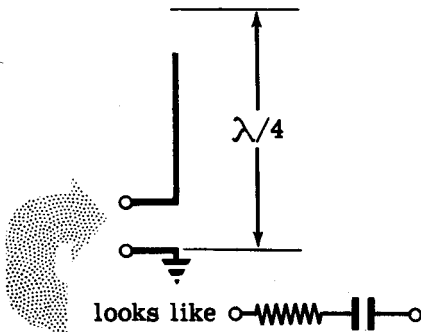

If a vertical quarter-wave grounded antenna is longer than a quarter wavelength, the input impedance at its base is resistive and inductive. The antenna can be electrically shortened by adding the right size capacitor to cancel the inductance, thus leaving the antenna resistive.

**TOO LONG**

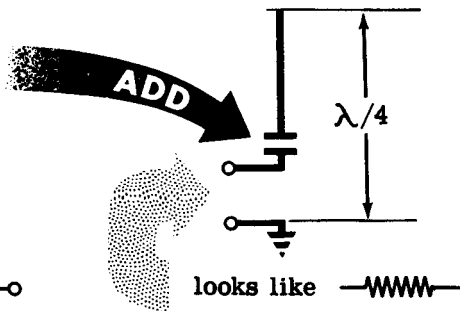
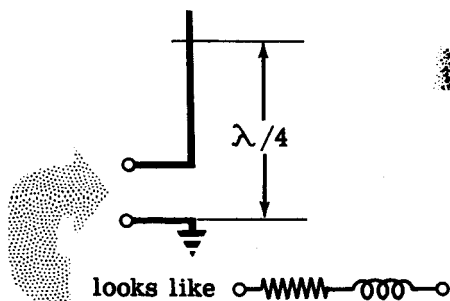

# ANTENNAS

## Radiation Pattern

When an antenna radiates electromagnetic waves, the radiation will be stronger in some directions than in others. The antenna is said to be directional along the line of strongest radiation which is at right angles to a point of maximum current on the antenna.

A radiation tester, called a "field strength meter," can be used to measure the radiation strength at all points around the antenna. If these field strength readings are plotted on a three dimensional graph, the three dimensional curve obtained will be the antenna radiation pattern. The radiation pattern for a horizontally positioned half-wave dipole is doughnut shaped as shown. Observe that the thickest part of the doughnut pattern is in a plane which is at right angles to the antenna at its center. Maximum radiation takes place in this plane. The thinnest part of the doughnut lies along its axis which corresponds to the line of minimum radiation. If the antenna is rotated 90 degrees in a vertical plane, maximum radiation occurs in a horizontal plane.

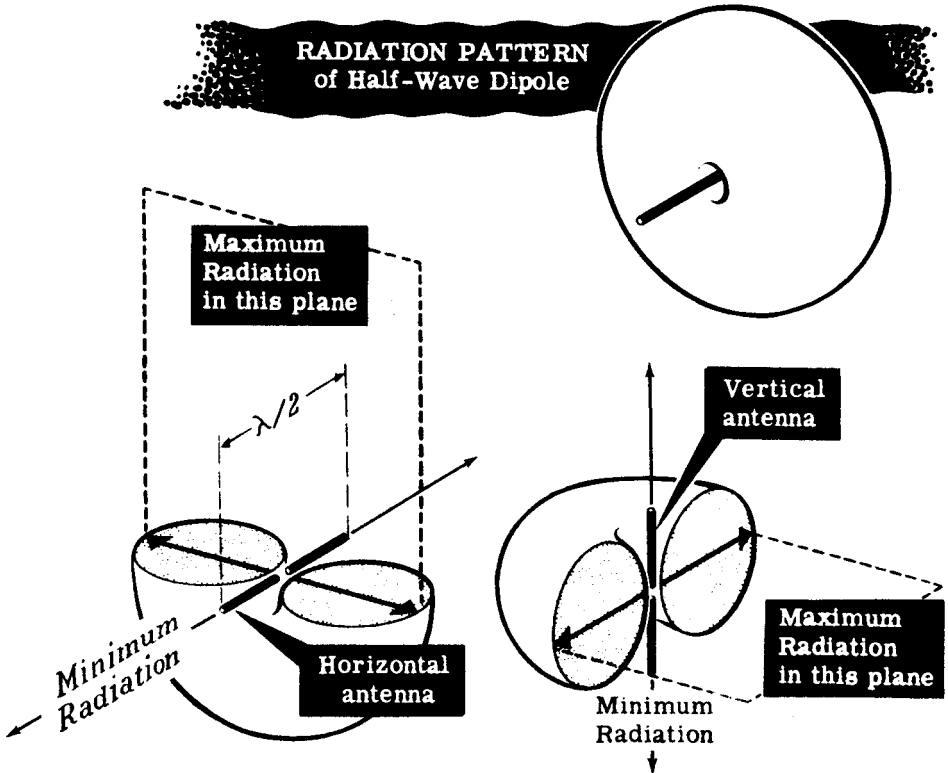

The above radiation patterns assume that the antenna is isolated in space away from all grounds. In actual practice, the antenna is located near ground surfaces so that the radiation pattern is altered appreciably from that shown above.



## ANTENNAS

### Wave Propagation

You know that the function of an antenna is to radiate electromagnetic energy into space. Once this energy is released from the antenna, it travels through space until it is picked up by a receiving antenna or is reflected off an object, as is the case with radar transmission.

It is important to know what happens to a radiated wave in space (namely, what its path is, if it is absorbed by the earth, if it is reflected by the sky, etc.) in order to tell how far the wave will travel before it can be picked up. The study of what happens to a radiated electromagnetic wave once it leaves the antenna is called "wave propagation."

When a radiated wave leaves the antenna, part of the energy travels through the earth following the curvature of the earth and is called the "ground wave." The rest of the energy is radiated in all directions into space. Those waves which strike the ground between the transmitter and the horizon are called "space waves." Waves which leave the antenna at an angle greater than that between the antenna and the horizon are "sky waves."

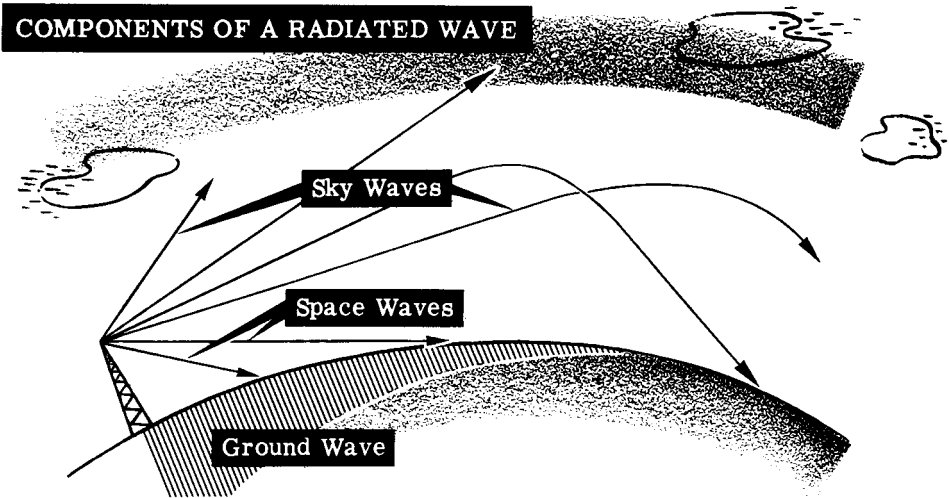

The ground wave, the space waves and the sky waves contain the transmitted intelligence. However, at certain frequencies one of the waves will be much more effective in transmitting the intelligence than the others. At comparatively low transmitted frequencies, most of the radiated energy is in the ground wave. Since the earth is a poor conductor, the ground wave is rapidly attenuated and therefore is not effective for transmission over great distances unless large amounts of transmitted power are used. The standard broadcast frequencies are examples of transmissions using ground waves. At these frequencies the effective radiating area is within 100 miles of the transmitter. As a result, neighboring cities more than 100 miles away from each other can transmit on the same frequencies and yet not interfere with each other.

## ANTENNAS

### Sky Wave and Ground Wave

At first one would be inclined to think that sky waves can serve no useful purposes since they will only travel straight out into space and get lost. For very high frequencies this actually happens and therefore the sky wave is useless. Below a certain critical frequency, however, the sky wave does not travel straight out but is bent back to earth in the upper layers of our atmosphere. This returning wave is not sharply reflected as is light from a mirror. It is bent back slowly as if it were going around a curve, and is therefore called a "refracted wave." This refracted wave, once it returns to earth, is reflected back to the sky again where it is once again refracted back to earth. This process of refraction from the sky and reflection from the earth continues until the wave is completely attenuated, since the energy of a radiated wave drops as its distance from the transmitting antenna increases.

A receiving antenna will be able to pick up a signal at every point where the refracted wave hits the earth. If the sky wave were radiated to the sky at only one angle, no signal would exist between points where the refracted wave hits the earth. The sky waves, however, are radiated at all angles to the sky and therefore the earth's surface (beyond a certain minimum distance from the antenna) is completely covered with radio signals. As the angle of radiation of the sky wave increases, an angle is reached where the wave is no longer refracted back to earth but continues traveling into space. As a result, there is a zone around the antenna in which no refracted sky wave hits the earth. The ground wave itself is only effective a short distance. Therefore, the zone between the maximum effective radiating distance of the ground wave, and the point where the first sky wave is refracted back to earth, is an area of radio silence (no signals) called the "skip zone."

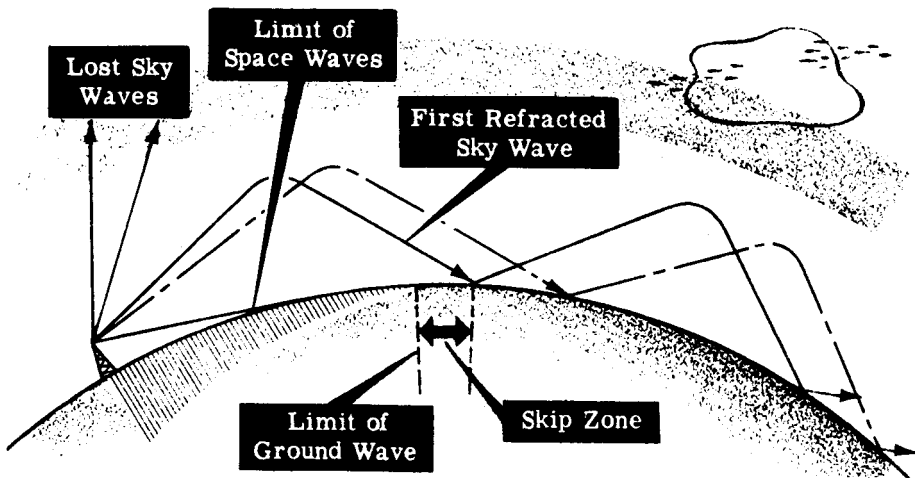

The critical frequency, which is the frequency above which no sky waves can return to earth, varies depending upon numerous factors such as the time of day, the time of year, the weather, etc. As a result, long distance communication can sometimes be achieved with frequencies which normally have no returning sky wave.

## ANTENNAS

### Space Wave and Fading

At frequencies above the critical frequency, neither the ground wave nor the sky wave can be used for transmission. At these high frequencies, the ground wave is rapidly attenuated and the sky wave is not refracted back to earth. As a result, the only radiated wave that can be used for transmission at these frequencies is one that travels in a direct line from the transmitting antenna to the receiving antenna. This type of transmission is called "line of sight transmission," and the radiated wave is called a "space wave."

Line of sight transmission is used in radar for detecting enemy craft and in ship-to-plane communication. The frequencies used are usually above 30 megacycles.

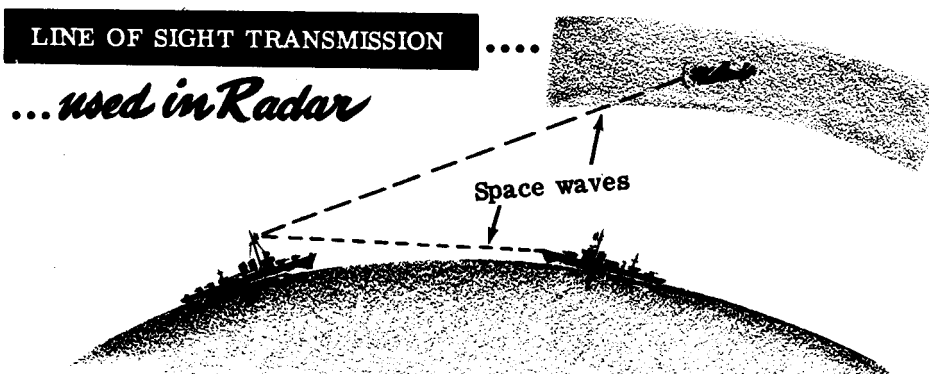

Sometimes a receiving antenna picks up two signals which have traveled along different paths from the same transmitting antenna. For example, one signal may travel direct from the antenna, and the other signal may have been reflected off an object. Since the signal paths are constantly changing, the two signals will sometimes be in phase and at other times be out of phase, thus tending to cancel or reinforce each other. The result is a variation in signal strength at the receiver end called "fading."

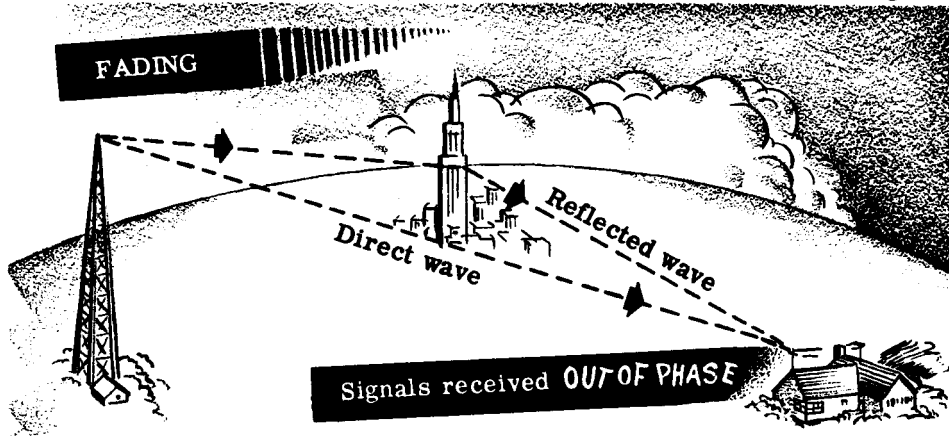

# ANTENNAS

## Frequency Spectrum

The following is an outline of the components of a radiated wave which are used for transmission at various frequencies:

From 30 to 300 kilocycles (low frequency band) the ground wave is largely used for medium range communication since its stability is not affected by seasonal and weather changes. For very long distance communication, the sky wave is used.

From 300 to 3000 kilocycles (medium frequency band), the range of the ground wave varies from 15 to 400 miles. Sky wave transmission is excellent at night for ranges up to 8000 miles. In the daytime, however, sky wave transmission becomes erratic, especially at the high end of the band.

From 3 to 30 megacycles (high frequency band), the range of the ground wave decreases rapidly and sky wave transmission is highly erratic depending upon the seasonal factors previously mentioned. Space wave transmission begins to become important.

From 30 to 300 megacycles (very high frequency band VHF), neither the ground wave nor the sky wave are usable, and space wave transmission finds major application.

From 300 to 3000 megacycles (ultra-high frequency band UHF), space wave transmission is used exclusively.

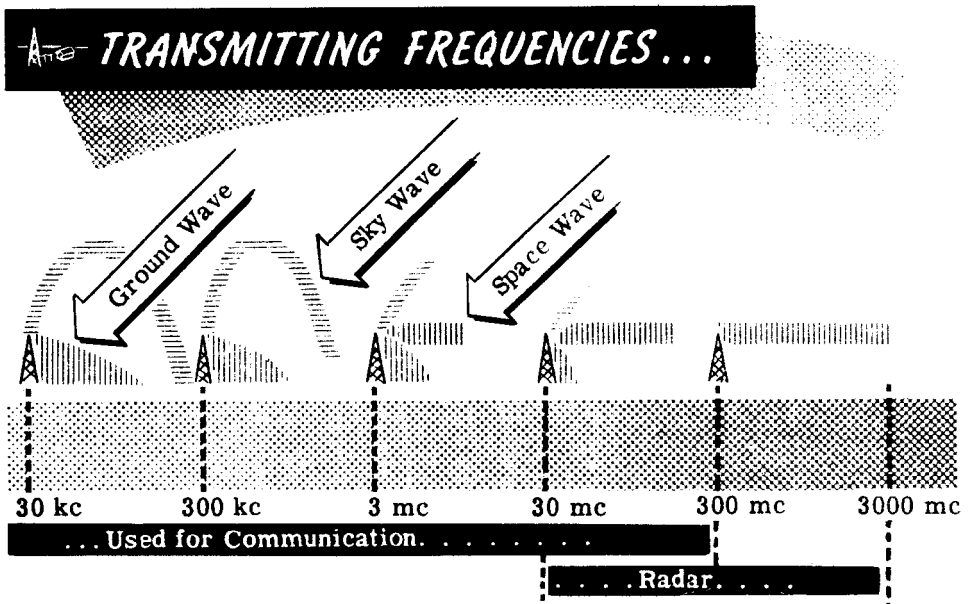

## ANTENNAS

### Demonstration—Current Distribution Along an Antenna

The very high frequency tuned-line transmitter is set to oscillate at about 160 megacycles. At 160 megacycles, a wavelength is about 6 feet long. Therefore, a quarter-wavelength is 1-1/2 feet (18 inches), which is the length of each pole of the doublet antenna.

The instructor connects a dipole antenna section to each transmitter output terminal. He then energizes the transmitter, and the oscillator tube filament starts to glow immediately. A quick check for oscillations is made by holding the glass end of a neon lamp and pressing one lead against one of the tuned lines. If the lamp glows it means that RF is present and therefore the tube is oscillating.

#### CHECK FOR OSCILLATIONS USING NEON LAMP

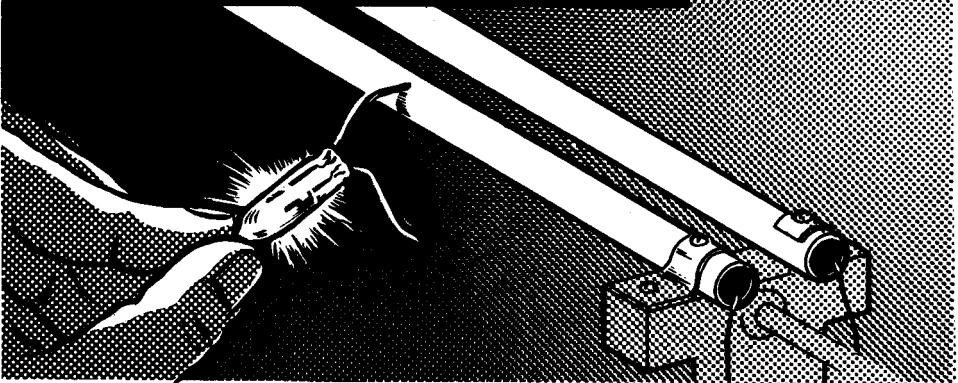

Once oscillations have been verified, the instructor demonstrates the presence of standing waves along the half-wave antenna by holding a fluorescent lamp close to and parallel with the antenna. The lamp is ignited by placing one end against the tuned line. The lamp glows at the ends and is out in the middle.

#### FLUORESCENT LAMP SHOWS

*Standing Waves*

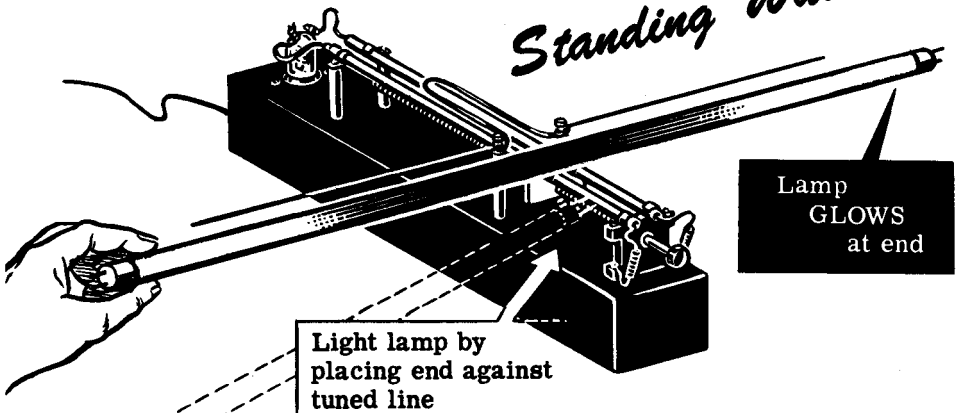

# ANTENNAS

## Demonstration—Radiation Pattern of an Antenna

To demonstrate the radiation pattern around the antenna, a wavemeter is used which is made up of a half-wave antenna connected to an RF current meter. A 73 ohm resistor is placed across the antenna input for proper termination and a germanium crystal diode and a capacitor are connected across the resistor. The crystal rectifies the RF and the capacitor filters out RF from the rectifier voltage. The DC milliammeter is connected across the capacitor through two RF chokes which block RF but pass DC through to the meter. When the antenna picks up RF radiation, the meter deflects an amount proportional to the intensity of the radiation.

# The Wavemeter

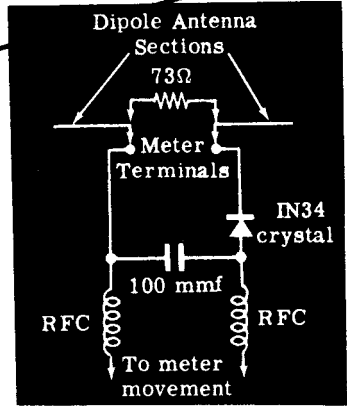
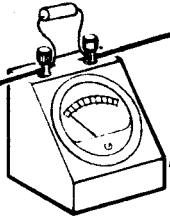

The instructor places the wavemeter far enough away from the transmitting antenna so that the meter needle does not deflect off scale. Then, the transmitter frequency is varied until the meter goes through a peak reading. At this point the transmitting antenna is exactly a half-wavelength long and is therefore radiating at maximum.

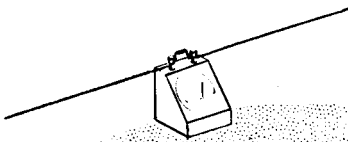

When the wavemeter reaches a Peak reading. . . . .

the antenna is exactly a Half Wavelength long

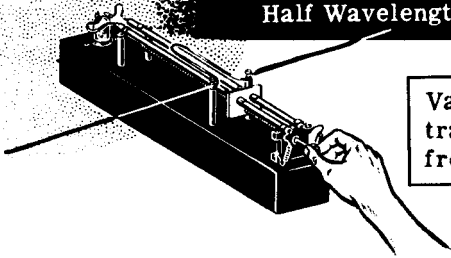

Vary the transmitter frequency

## ANTENNAS

### Demonstration—Radiation Pattern of an Antenna (continued)

Next, the instructor shows the intensity of the radiated field by placing the wavemeter at different positions around the antenna. Theoretically the radiation intensity is maximum in a plane at right angles to the antenna at its center and is minimum at the ends of the antenna. Actually this is not so since ground effects and multiple reflections around the room distort the radiation pattern.

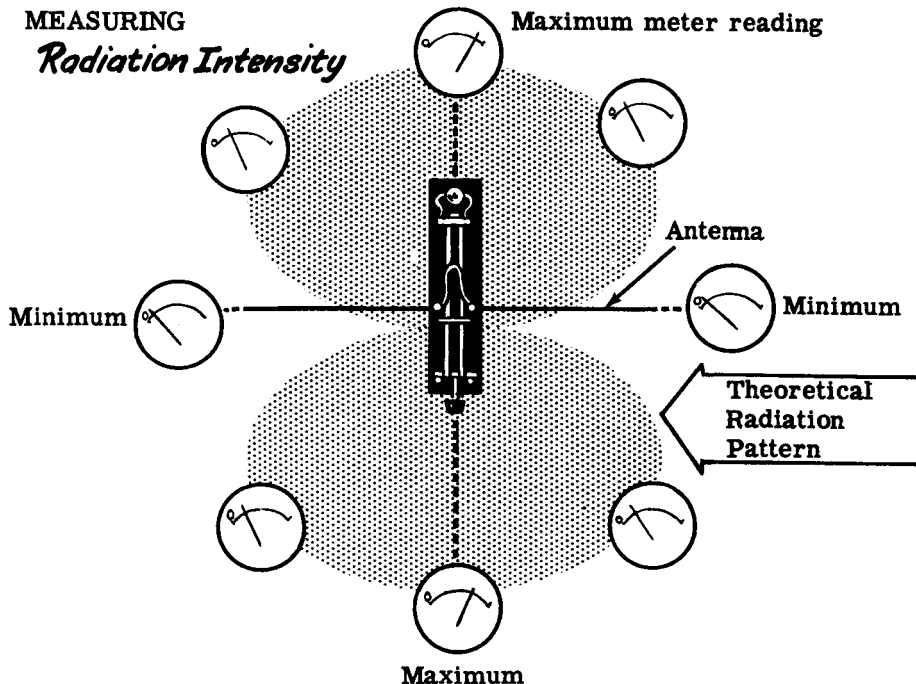

To show that movement of objects near the antenna affect the radiation pattern, the instructor sets the wavemeter down at a given point and walks between the meter and the antenna. Observe that the meter reading varies sharply as the instructor walks about.

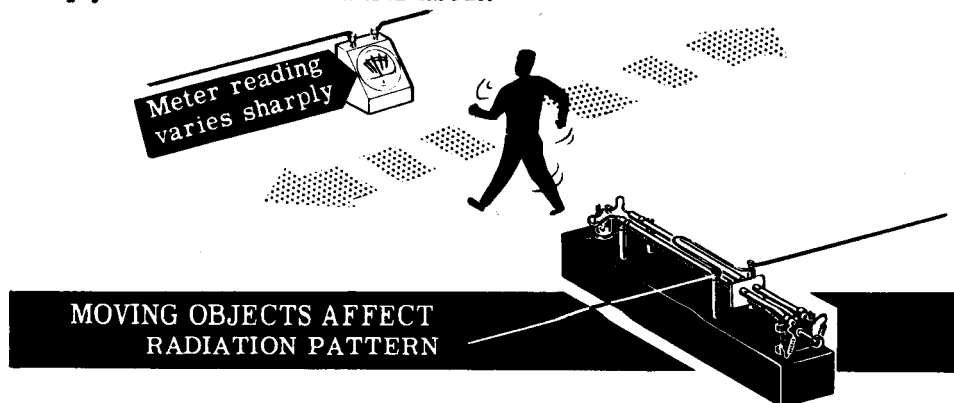

## ANTENNAS

### Demonstration—Radiation Pattern of an Antenna (continued)

The instructor demonstrates another type of wavemeter using a half-wave dipole connected to a pilot lamp. When the antenna picks up radiation, there will be a maximum of current at its center, which will flow through the lamp causing it to light.

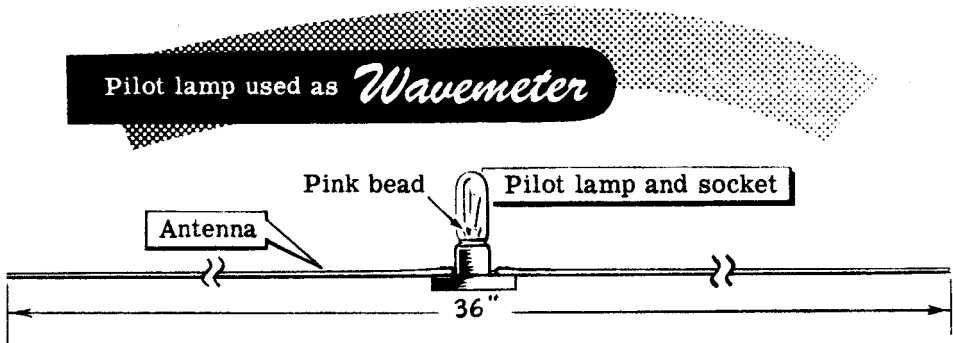

First, the transmitter is retuned until the bulb is brightest. Then, the intensity of the radiation around the antenna is demonstrated by moving the dipole, parallel to the antenna, from the center out to either end. Observe that the bulb is brightest when the center of the wavemeter dipole is lined up with the center of the antenna, and the bulb goes out when the center of the wavemeter dipole is in line with the end of the transmitting antenna.

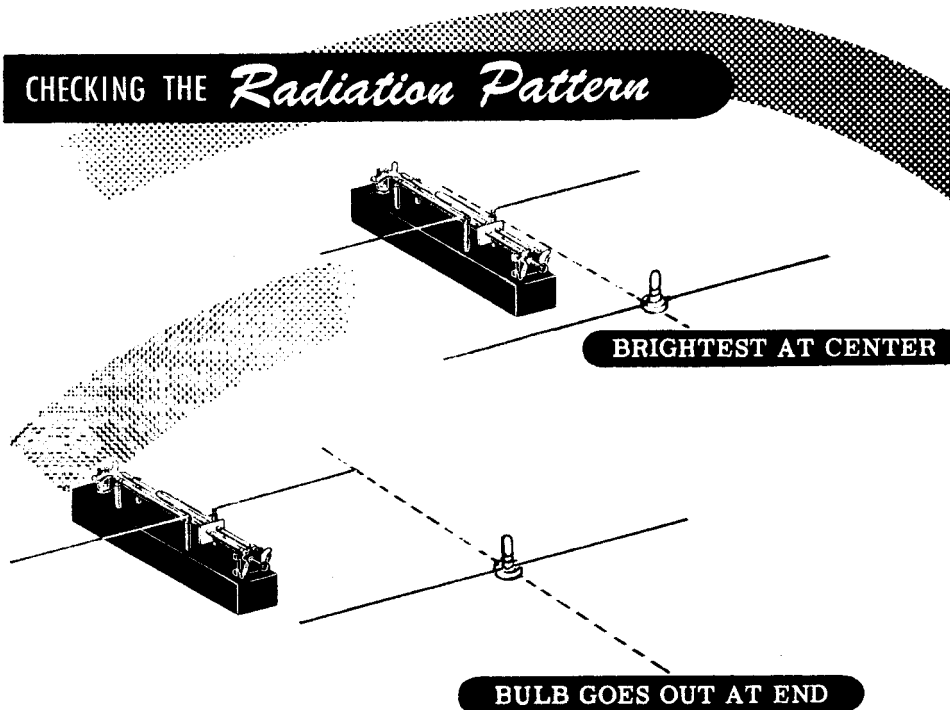



# ANTENNAS

## Review of Antennas

**HALF-WAVE DIPOLE** — A half-wave dipole antenna can be considered as a parallel wire transmission line whose wires are bent at 90 degrees to the line a quarter wavelength from the open end.

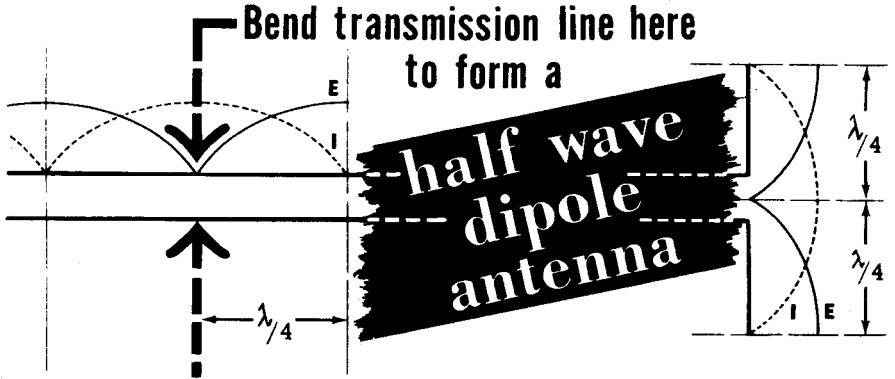

**RADIATION** — The voltage and current distributions along the antenna generate electric and magnetic fields at right angles to each other which are radiated into space as electromagnetic waves. These waves contain the intelligence of the modulating signal and can be detected by distant receivers.

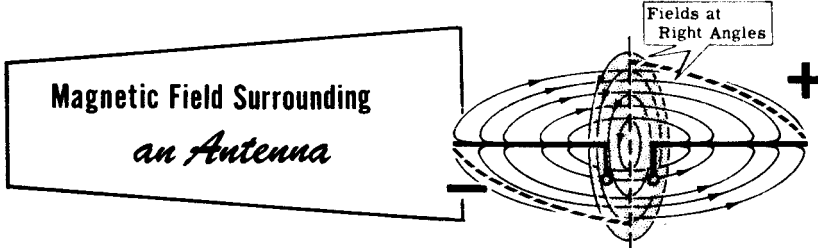

**WAVE PROPAGATION** — The energy radiated from an antenna consists of sky waves, space waves and ground waves. Each of these is used for transmission at frequencies for which it is best suited.

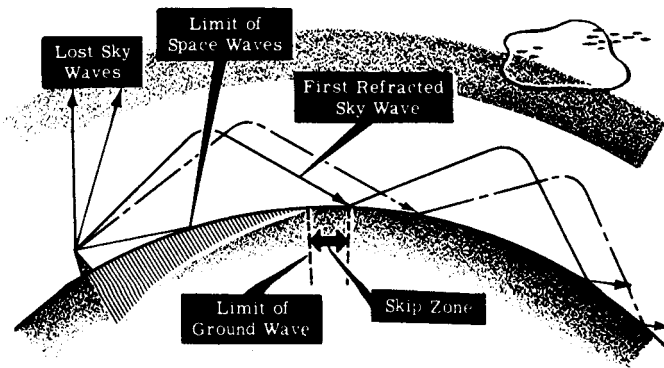

# CW TRANSMISSION

## Advantages of CW Transmission

You may remember from the introductory topic on transmitters that a message can be transmitted by either code or voice. Code transmission is either CW (continuous wave) or MCW (modulated continuous wave). In both cases the RF radiated by the antenna is turned on and off by a hand key in dot and dash sequence.

CW transmission is used very widely. When a transmitter is modulated by voice or MCW, it sends out not only the carrier frequency, but also the sum and difference (beat) frequencies of the carrier and the modulation signal. These additional frequencies are called "sideband frequencies." A receiver, in order to pick up a voice or MCW signal, must be broadly tuned so that it will pick up both the carrier and the sidebands. As a result the receiver may pick up a nearby signal in addition to the desired one. This interference may make it impossible to understand the desired signal.

CW transmission, on the other hand, does not contain sidebands. Notice that the receiver would not need to cover as wide a range of frequencies for a CW signal as it would for a voice signal. Therefore, there is not likely to be interference when receiving a CW signal. This is the main advantage of CW over either MCW or voice.

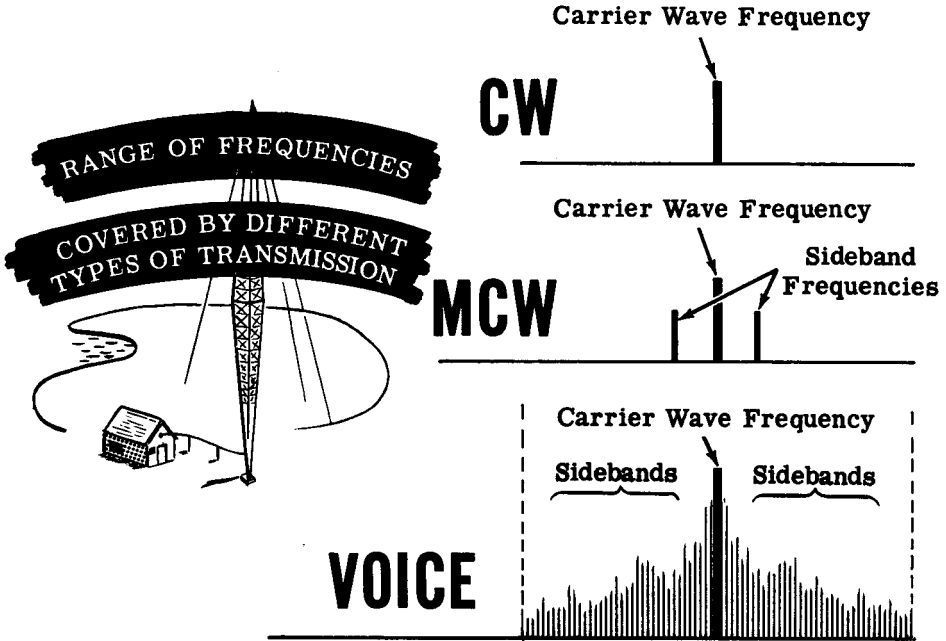

There are many different circuits which are used to obtain CW transmission. They look different and operate differently, but each has the same purpose—to turn the RF of the transmitter on and off. You will learn about some of these circuits on the next few sheets. In the next topic, you will find out more about MCW and voice transmission.

# CW TRANSMISSION

## Cathode Keying

Regardless of the circuit used, the CW output of a transmitter looks like a series of pulses of RF separated by gaps of no RF. The gaps between the RF pulses occur when the key is up, while the length of each RF pulse is determined by the length of time the operator holds the key down.

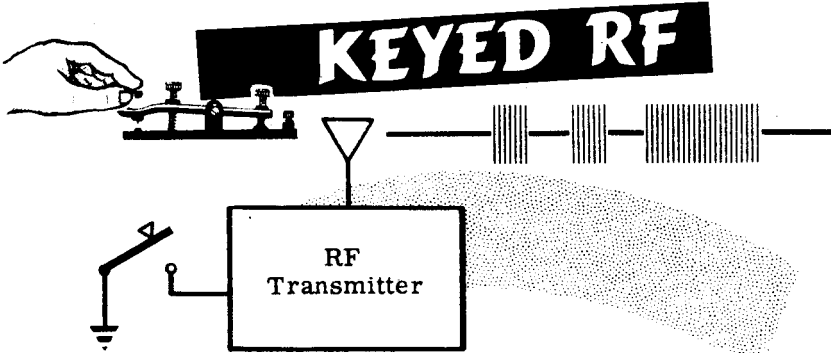

The simplest and most commonly used method of obtaining CW transmission is by "cathode keying." In this type of circuit, the key is connected in the cathode's DC return to ground. Thus, when the key is opened, no current can flow and no RF can be radiated from the antenna. When the key is closed, the circuit operates normally. The stage that is usually keyed in this manner is the master oscillator itself or the master oscillator plus one or more of the following amplifier stages.

## TYPICAL

### CATHODE KEYING CIRCUITS

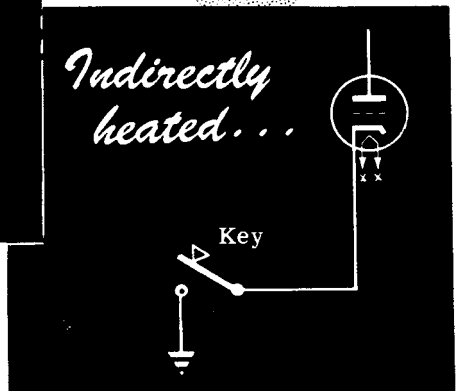
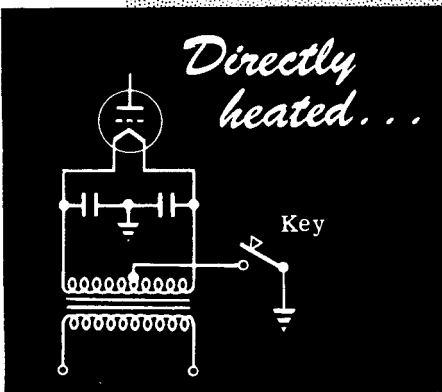

## CW TRANSMISSION

### Cathode Keying (continued)

The disadvantage in using direct cathode keying is that the operator will get a shock if he gets his fingers across the key contacts, while the key is open. When the key is up, the series circuit of the key, tube and B+ is open at the key and no current can flow. With the operator's fingers across the contacts, the circuit is completed and current flows. The plate resistance of the tube and the resistance of that part of the operator's hand across the key contacts form a voltage divider circuit across B+.

The resistance of the operator's hand will usually be large compared to the plate resistance, with the result that most of the B+ voltage will be across the key and therefore the operator's hand.

*This is equivalent to this*

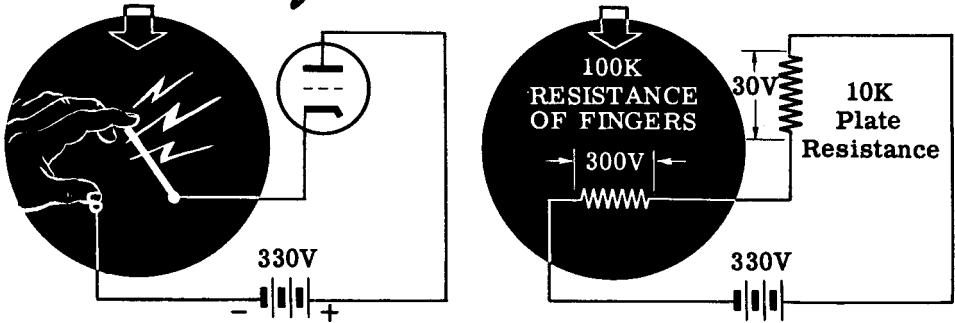

**HOW A VOLTAGE DEVELOPS ACROSS THE OPEN KEY CONTACTS**

To safeguard the operator, a slight variation is made on this basic circuit. The variation involves the use of a relay. The key is connected to a low voltage circuit containing the coil of the relay. When the coil of the relay is energized, the contacts of the relay, which are in series with the cathode circuit close, permitting the stage to operate normally.

**KEYING CIRCUITS USING RELAY**

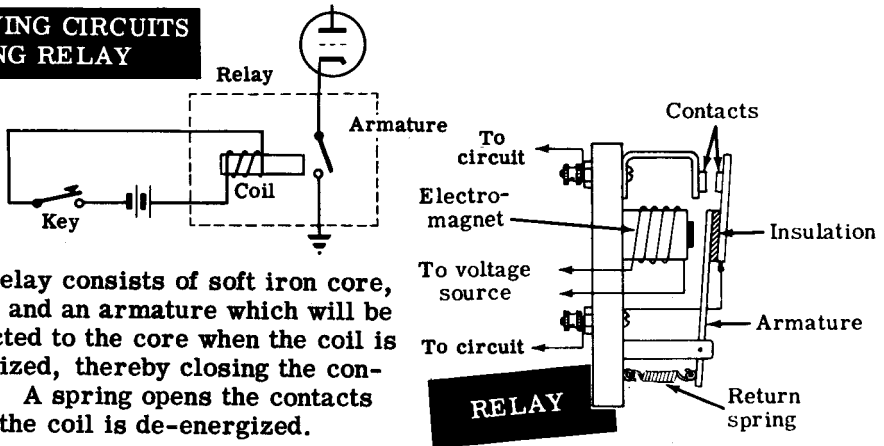

The relay consists of soft iron core, a coil and an armature which will be attracted to the core when the coil is energized, thereby closing the contacts. A spring opens the contacts when the coil is de-energized.

## CW TRANSMISSION

### Blocked-Grid Keying

Keying can also be accomplished by changing the grid voltage of the stage being keyed. When the key is open, the grid bias is many times cut-off, so that the RF grid signal can never bring the tube into conduction. As a result, no RF signal appears at the plate. When the key is closed, the bias is the normal value for Class C operation and the stage operates normally. This type of keying is known as "blocked-grid keying."

In the circuit shown below, the key (or relay) controls the DC bias on the grid of an intermediate power amplifier. With the key open, the voltage on the grid is equal to C- which is many times cut-off. With the key closed, the grid is connected to a voltage divider which provides normal operating bias to the tube. Therefore with the key down, the transmitter is sending out an RF signal. This signal is interrupted each time the key is opened.

The same idea can be applied to the screen grid. The circuit on the right is for screen grid keying. In this circuit, the voltage varies from a positive operating voltage, with the key closed, to a negative blocking voltage with the key open. When the key is opened, the screen is connected through resistor, R, to C- which is sufficient to cut off the stage completely. When the key is closed, the screen is connected directly to B+. The purpose of R is to limit the current flowing from C- to B+ when the key is closed. In this circuit, as in the last, a relay (not shown) is used in place of the key to protect the radio operator from high DC voltages.

### BLOCKED GRID KEYING CIRCUITS

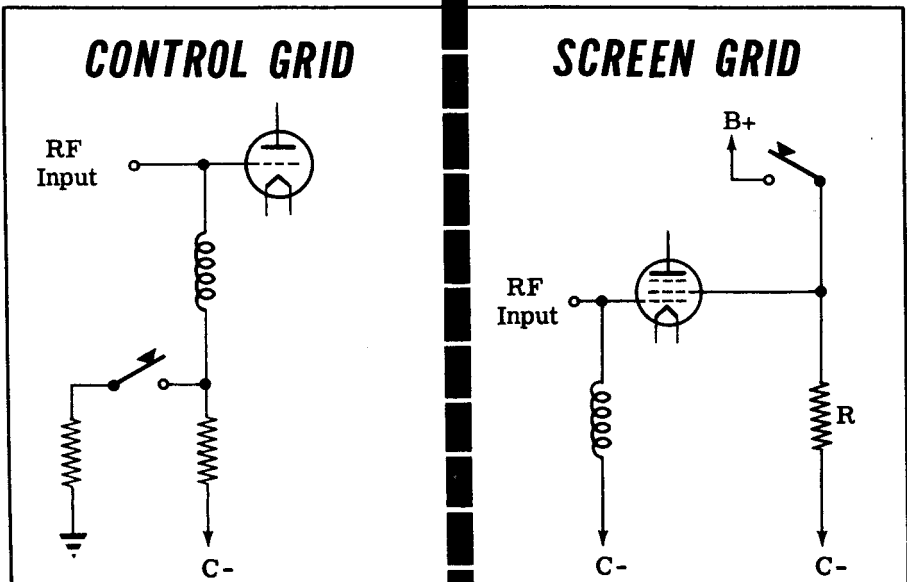

## CW TRANSMISSION

### Keyer Tube Circuits

Relay or key contacts cannot close or open circuits as quickly as a vacuum tube can start or stop conducting. Therefore some applications use one or more vacuum tubes to key the RF circuits. These tubes are called "keyer tubes." There are several variations of keyer tube circuits, but they all turn the transmitter on when the hand key is closed and off when the key is opened.

In the circuit shown below, the keyer tube is connected in series with the cathode of the power amplifier tube. The transmitter will be on when the keyer tube conducts and will be off when the keyer tube is cut off. The keyer tube can be keyed by any of the blocked-grid keying methods described previously.

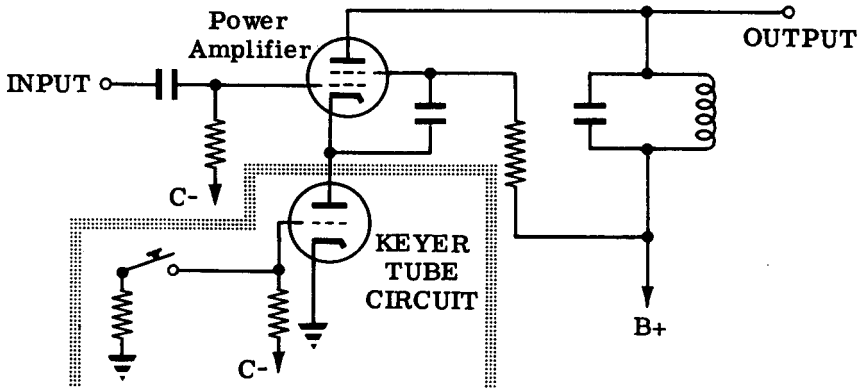

A simplified schematic of another type of keyer tube circuit is shown below. With the key open, current flows through R-1 and R-2 producing a large voltage drop across these resistors. Resistor R-1 is the PA screen dropping resistor and resistor R-2 is the PA plate dropping resistor. The keyer tube current flows through R-1 and R-2 causing the power amplifier's screen and plate voltages to drop, thereby cutting off the power amplifier. When the key is closed, C- is applied to the grid of the keyer tube so that it will be cut off. As a result, the screen and plate voltages of the power amplifier increase to their normal values, the power amplifier conducts, and the transmitted pulse is radiated from the antenna.

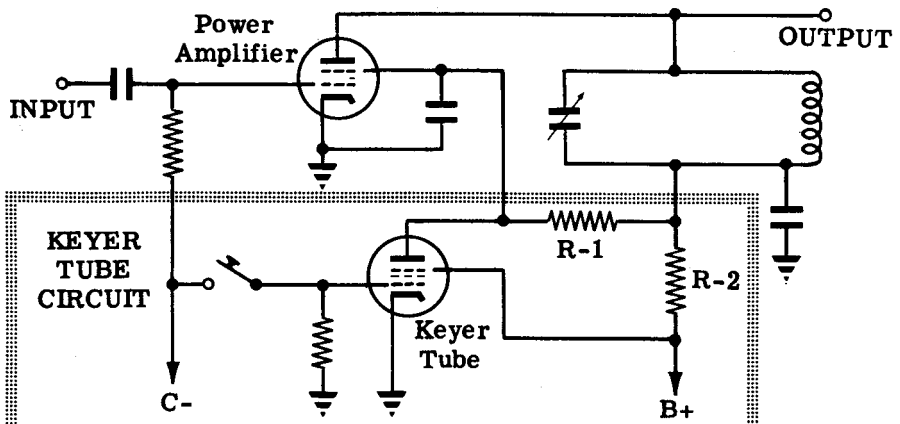

# AMPLITUDE MODULATION

## What Amplitude Modulation Is

The type of voice transmission most commonly used is one in which the amplitude of the carrier is varied in accordance with the amplitude of the voice signal. This method of modulating the carrier is called "amplitude modulation." MCW transmission is amplitude modulation in which a steady audio frequency is used, instead of voice, to vary the amplitude of the RF carrier.

In addition to the oscillator and power amplifiers, an AM transmitter contains a modulator, which applies the audio frequency signal to the PA where it is combined with the RF carrier wave. A block diagram of a typical voice AM transmitter is shown below.

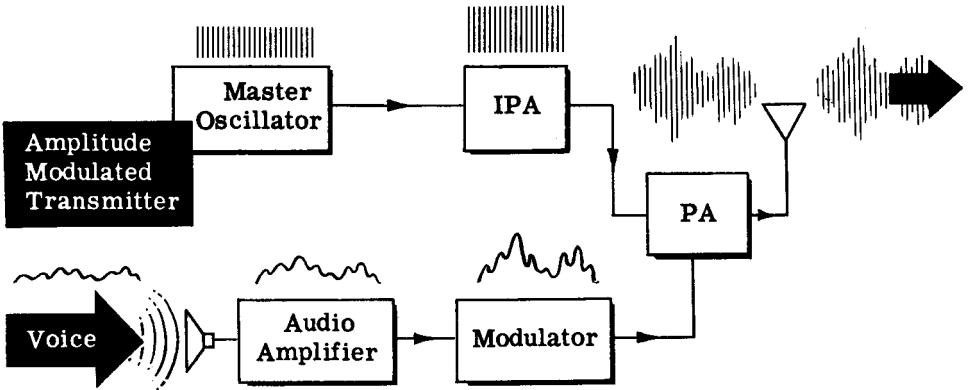

In the operation of an AM transmitter, it is essential that the modulator unit be on during transmission because the intelligence that is to be transmitted must come through the modulator. If the modulator is either off or defective, only unmodulated RF will be transmitted and a receiver at some distant point will not receive any message.

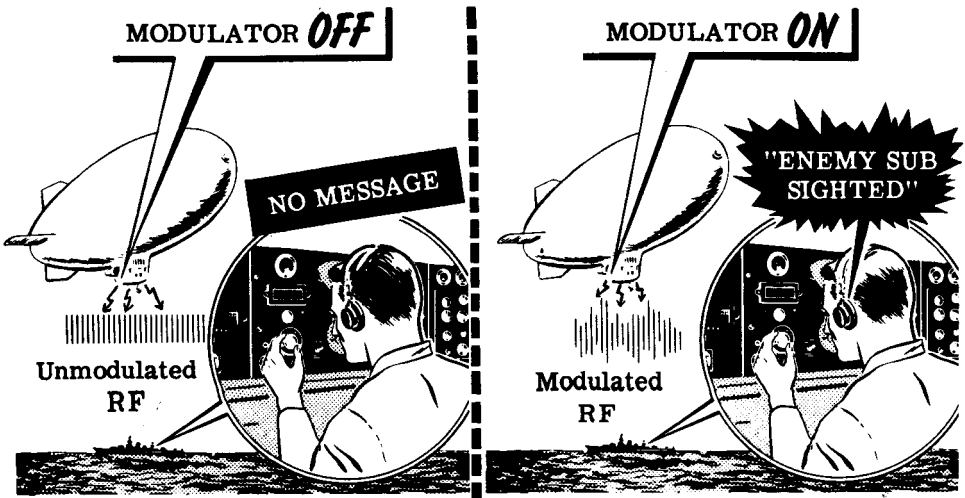

# AMPLITUDE MODULATION

## Sidebands

When an RF carrier is amplitude modulated, the effect is to add new frequencies to the transmitted signal in addition to the original carrier frequency. For example, if in MCW transmission a 500 kc carrier is modulated with a 2000 cycle audio note, the frequencies radiated by the antenna will contain, in addition to the carrier frequency, the sum (502 kc) and difference (498 kc) frequencies between the carrier and the modulating audio frequency. These new frequencies are called "sidebands"—the higher frequency being known as the "upper sideband" and the lower frequency the "lower sideband." The range of frequencies transmitted from the lower sideband to the upper sideband is known as the "bandwidth" of the transmission. In the above example the bandwidth is 4 kc—from 498 kc to 502 kc. If the modulating audio signal is reduced in frequency from 2000 to 1000 cycles, the sidebands will be closer to the carrier frequency and the bandwidth will be only 2 kc. It is the sideband frequencies, and not the carrier frequency, that contain the intelligence of the transmission. If, for example, an MCW receiver were to pick up only the carrier and exclude the sidebands, no intelligence would be heard.

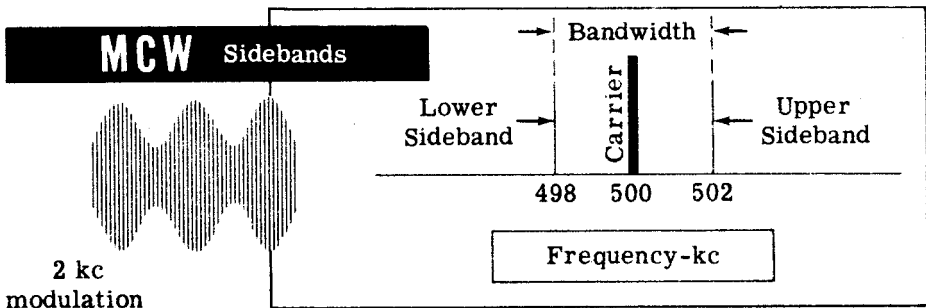

In a voice transmission, the modulating signal contains many frequencies—some as high as 5000 cycles per second. As a result, voice transmissions contain many sidebands (one sideband for each frequency) which may be as much as 5 kc above and 5 kc below the carrier frequency. This type of transmission, therefore, may cover a range of frequencies 10 kc wide.

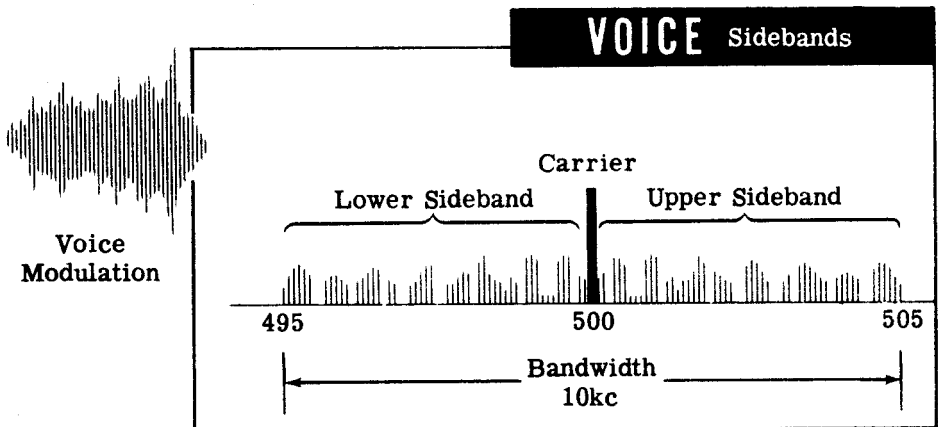



# AMPLITUDE MODULATION

## How Modulation Is Accomplished

In an unmodulated transmitter, the amplitudes of the plate current pulses in the Class C amplifiers are the same, cycle after cycle. These plate current pulses flow to an LC circuit which is tuned to the RF frequency or a multiple of it. The pulses of current deliver a certain amount of power to the tuned circuit and this power remains the same for each cycle. Therefore, the amplitude of RF voltage across the tuned circuit remains the same for every cycle.

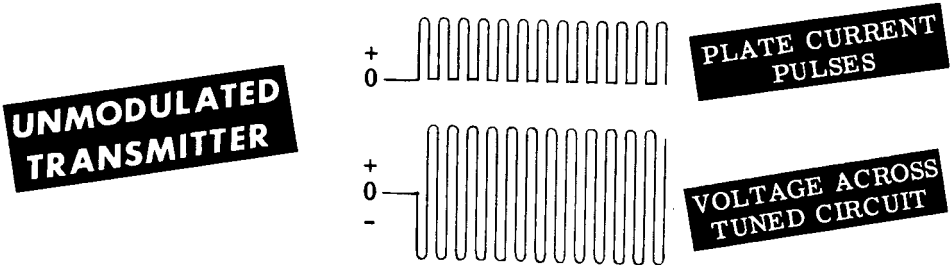

When the transmitter is modulated, the amplitude of the plate current pulses is made to vary according to the amplitude of the modulating signal. Thus the amplitude of the RF current varies from one cycle to the next and the power delivered to the tuned circuit also varies. This varying power causes the RF voltage across the tuned circuit to vary. These variations will follow the modulating signal in amplitude and frequency. This is how modulation is accomplished.

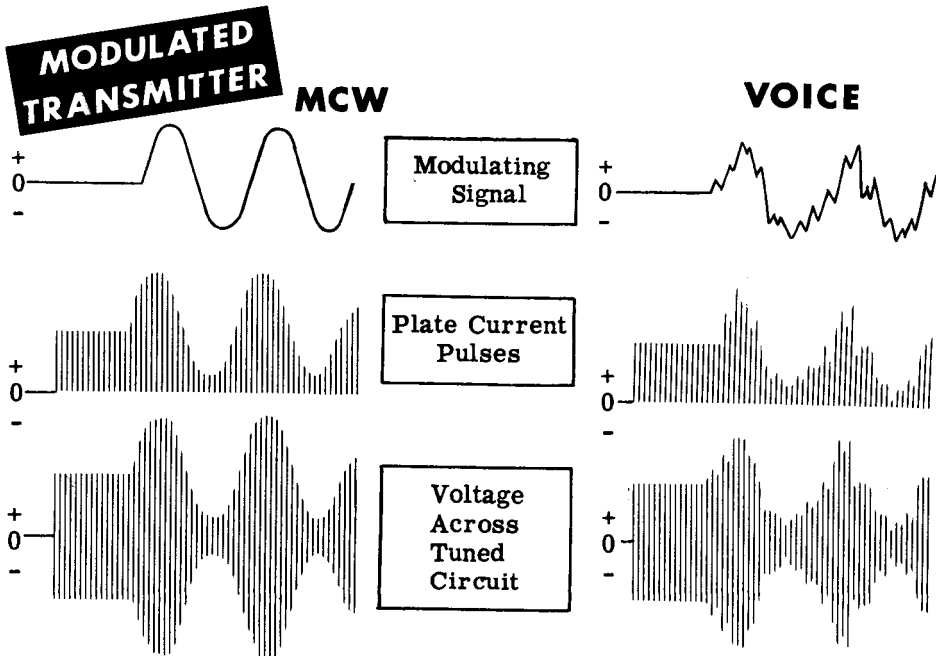

## AMPLITUDE MODULATION

### The Modulator

In MCW and voice amplitude modulation, a modulator is used to impress the audio on the RF. For voice, the modulator is nothing more than an ordinary audio amplifier which provides the voltage or power needed to vary the amplitude of the transmitter's RF. For MCW, the modulator contains an audio oscillator which drives the audio amplifier. The output is a pure sine wave which varies the amplitude of the RF pulses in the same manner as the amplitude of the audio varies.

Since the modulator is connected to the stage of the transmitter that is to be modulated, its output must be of sufficient power to produce the necessary variations of current in the modulated stage of the transmitter. For this reason, Class B push-pull amplifiers are often used as the final stage in the modulator unit.

The following schematic illustrates a push-pull amplifier which can be used as a modulator. It is almost exactly the same as the push-pull amplifier shown in Volume 2 of Basic Electronics. The only difference lies in the modulation transformer which has a different turns ratio and higher current capacity than the previously used output transformer.

### PUSH-PULL AMPLIFIER

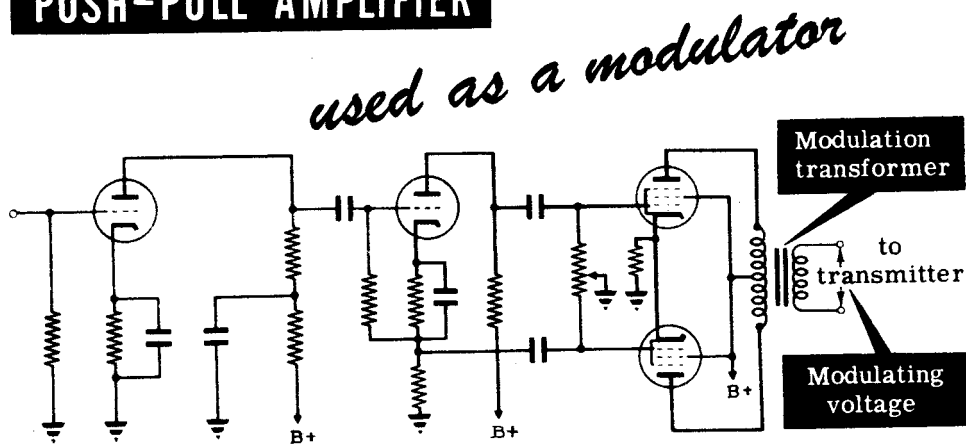

The modulating voltage may be applied in series with any of the tube's elements. The name of the type of modulation used depends on the tube element to which the secondary winding of the modulation transformer is connected. For example, plate modulation is achieved by connecting the output of the modulator in series with the plate circuit. Other types of modulation used with triode tubes are grid modulation and cathode modulation. In pentode tubes, screen grid modulation or suppressor grid modulation may be used in place of the other methods.

# AMPLITUDE MODULATION

## Plate Modulation

In the simplified circuit of the power amplifier shown below, the modulating audio voltage is applied to the plate of the tube. The audio voltage, since it is in series with the DC plate supply voltage, will cause the total applied plate voltage to vary above and below  $B+$  by an amount equal to the peak audio voltage and at a rate equal to the frequency of the audio.

Simplified circuit for

## Plate Modulation

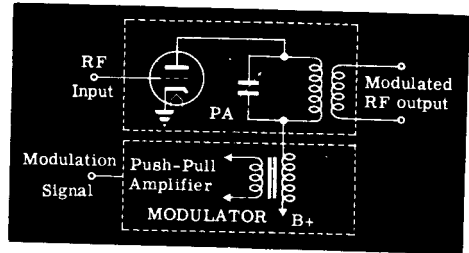

While the applied plate voltage is varying, a constant amplitude of RF is being fed to the grid of the tube from the output of the previous stage, the IPA.

During the positive cycles of the audio, the plate voltage of the PA is higher than  $B+$  and as a result more plate current flows. Therefore, on the positive half-cycles of the AF modulating voltage, a greater RF voltage is developed across the tuned circuit. During the negative cycles of the audio, the plate voltage is lower than  $B+$ , resulting in less current flow and less voltage developed. As a result, the amplitude of the output voltage varies in the manner shown. The wave illustrated is an amplitude modulated wave.

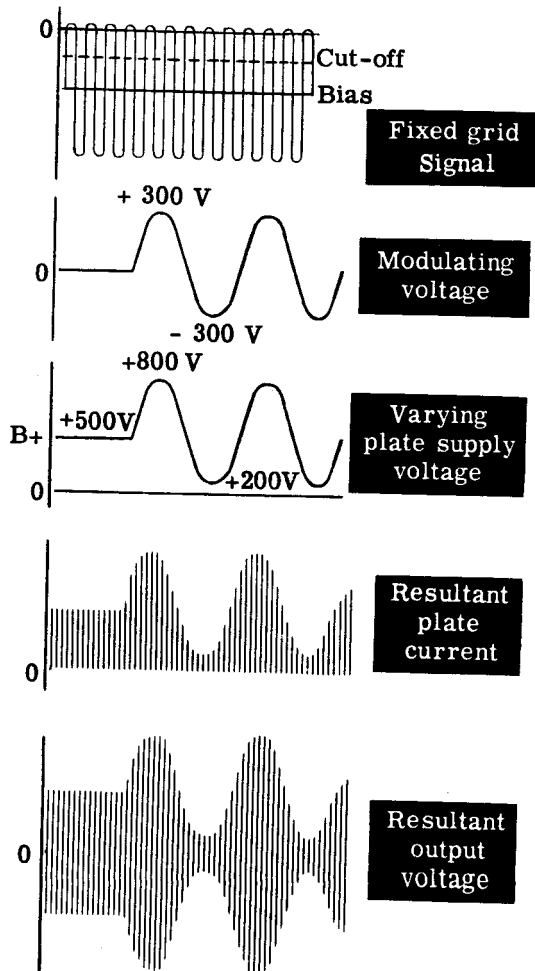

# AMPLITUDE MODULATION

## Grid Modulation

If the audio voltage is applied in the grid circuit instead of the plate circuit, you have grid modulation. The effect of the modulating voltage is to vary the grid bias at an audio rate. As a result of this, the plate current that flows during each RF cycle will vary as the grid bias increases and decreases.

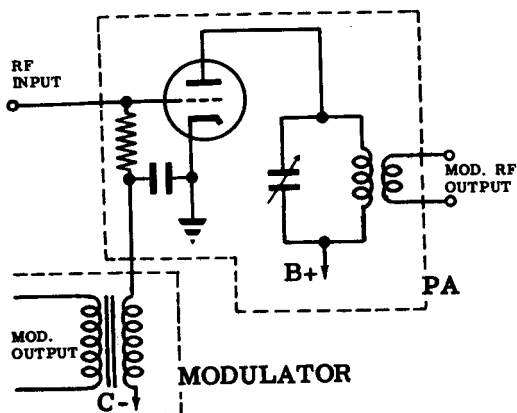

CIRCUIT FOR  
*Grid Modulation*

In the accompanying wave forms you can see that the total grid voltage is the sum of three voltages—the RF input voltage, the AF modulating voltage and the DC bias voltage. During the positive half-cycles of the modulating voltage the bias decreases and during the negative half-cycles, the bias increases. Since the RF will always vary about the bias level, the positive cycles of RF are raised during positive modulation peaks and depressed during the negative modulation peak. As a result, the plate current pulses are larger in amplitude during the positive half-cycles of the audio voltage than during the negative half-cycles. Since the voltage developed across the plate tank varies with the plate current amplitude, the RF output voltage also varies according to the modulating signal.

Grid Voltage

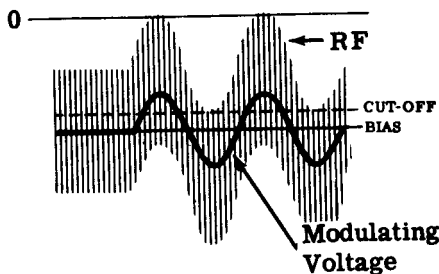
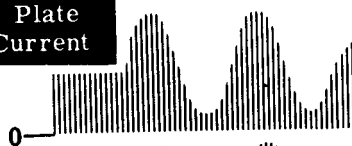
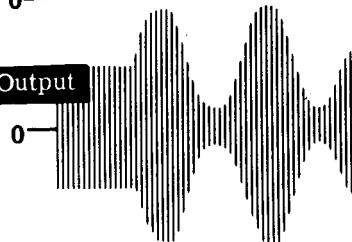

Plate Current



Output



Grid modulation is used in compact or mobile transmitters because this type of modulation does not require a modulator with a large power output. When the modulator's weight is only a minor consideration, plate modulation with the larger modulator it requires is used because it produces much better results than grid modulation.

# AMPLITUDE MODULATION

## Other Methods of Modulation

Plate voltage has almost no effect on the plate current in a pentode or a tetrode and in these tubes plate modulation is never used. Instead the audio voltage is applied to the screen grid and the results are almost identical to those of plate modulation with a triode.

### Screen Grid Modulation

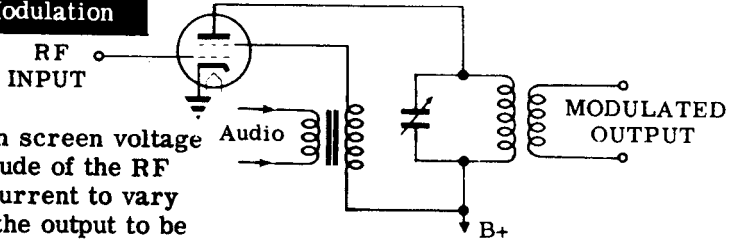

The variations in screen voltage cause the amplitude of the RF pulses of plate current to vary and this causes the output to be modulated by the audio signal.

Modulation can also take place when the audio output of the modulator is connected in the circuit of the suppressor grid. With a negative voltage on it, the suppressor can control plate current the same way a control grid can, except that the tube is less sensitive to voltage changes on the suppressor. Of course, only pentode tubes which have external connections to the suppressor can use this type of modulation. The operation is very similar to control grid modulation and the modulator does not need a large power output.

### Suppressor Grid Modulation

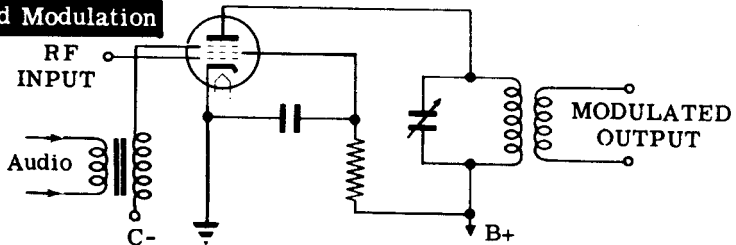

If the audio voltage were applied to the cathode (or filament) of the tube, the cathode's voltage would vary with respect to ground. This would have the same effect as applying the audio voltage to every other element in the tube simultaneously; applying the voltage to the cathode causes the voltage on every other tube element to vary with respect to the cathode. Therefore cathode modulation is, in effect, a combination of the other types of modulation. The only difference is that as the cathode's voltage is raised, the current decreases.

### Cathode Modulation

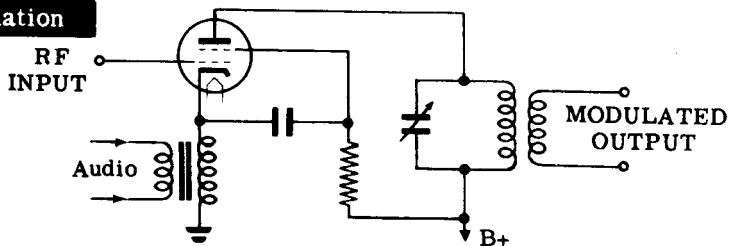

## AMPLITUDE MODULATION

### Time Base Modulation Pattern

The oscilloscope can be used to good advantage to indicate the extent to which the output of a transmitter is modulated. It can also point out distortion existing in the modulation. If a pickup loop, which is connected to the 'scope input terminals, is brought close to the plate tank coil in the output circuit of a modulated transmitter, the 'scope will show the modulation pattern.

### TIME-BASE

### *Modulation Pattern*

If the modulating voltage is a sine wave (as in MCW) and the sweep (called the time-base) is produced inside the oscilloscope, the pattern on the right is obtained. This pattern is useful in determining the presence of distortion.

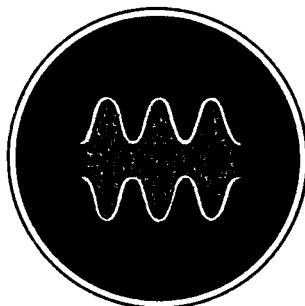

A pattern such as this would indicate that the positive peaks of the modulating voltage are not causing corresponding peaks in plate current. This may be due to improper grid bias, saturation due to low emission, or insufficient excitation of the power amplifier stage.

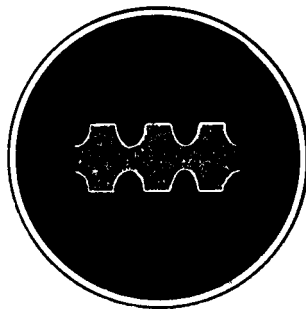

If the transmitter output shows breaks in the modulation pattern, the transmitter is said to be "over-modulated." This is usually due to excessive modulating voltage but may also be due to insufficient signal voltage on the grid or excessive grid bias voltage.

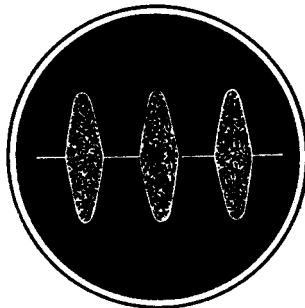

## AMPLITUDE MODULATION

### Trapezoid Figure

The trapezoid figure is another type of oscilloscope pattern that is often used to determine the presence of distortion in the modulated signal and also how much the signal is being modulated. The trapezoid figure has the advantage of making possible the detection of certain types of distortion which cannot be detected by means of the time-base pattern. To produce the trapezoid figure, the modulating signal is used as an external horizontal sweep signal instead of the internal sweep of the 'scope. The vertical deflection is still the modulated RF output of the transmitter. The advantage of using trapezoid figures over time-base modulation patterns to analyze the operation of a transmitter is that they are easier to interpret.

A typical set-up for showing trapezoid figures is illustrated below. The vertical input of the 'scope is coupled to the plate coil of the power amplifier and the horizontal input is coupled to the audio output of the modulator.

In order to understand how trapezoid figures are formed, you have to know something about the action of the vertical and horizontal plates inside the cathode ray tube.

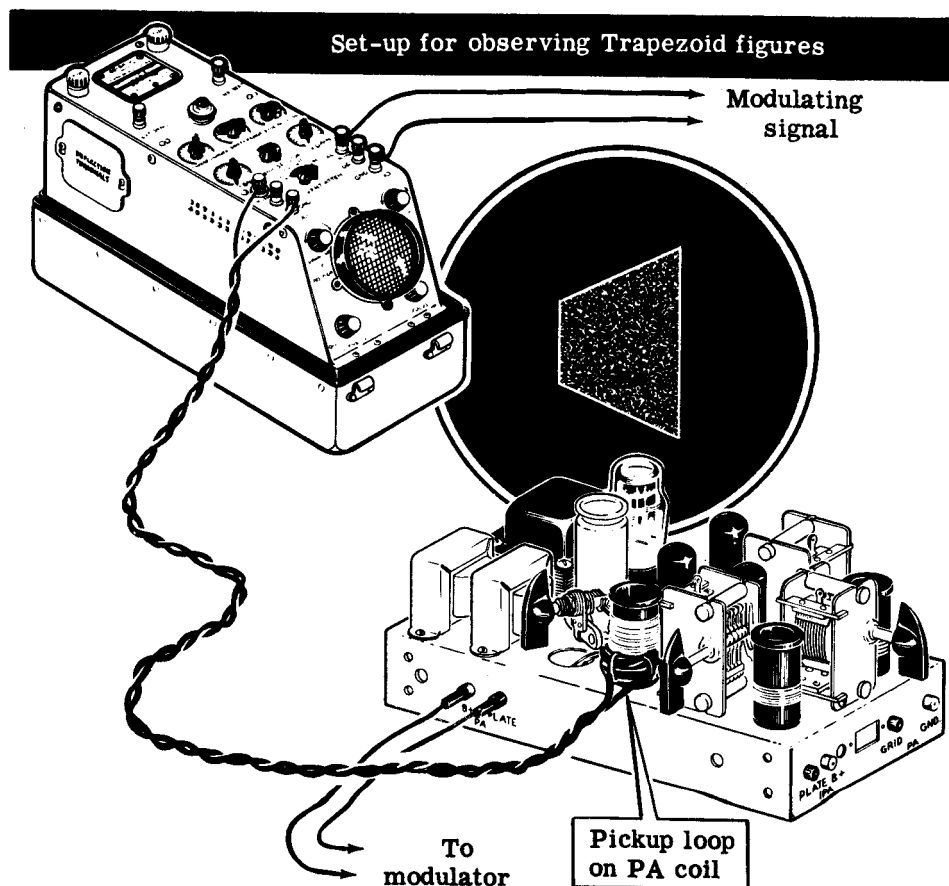

## AMPLITUDE MODULATION

### Trapezoid Figure (continued)

The picture you see on an oscilloscope screen is the path followed by a beam of electrons striking the inner surface of the cathode ray tube. In the cathode ray tube there are two pairs of metal plates which deflect the electron beam from its path. The top and bottom plates are called "vertical plates" because they move the electron beam vertically. The left and right plates are called "horizontal plates" and they move the electron beam horizontally from left to right.

The vertical plates are connected to the signal under observation. This signal displaces the electron beam in a vertical direction. Under normal operating conditions, the horizontal plates are connected to the output of an oscillator built into the oscilloscope. This oscillator, called a "sweep" oscillator, generates a saw tooth voltage which sweeps the electron beam across the face of the 'scope screen, from left to right, at a constant speed. If the input signal to the vertical plates is the familiar sine wave of voltage, the combined action of this signal and the horizontal sweep acting on the electron beam produce the sine wave picture.

Sometimes the internal horizontal sweep is disconnected and an external signal is used as the sweep voltage. This is what is done to produce the trapezoid figure.

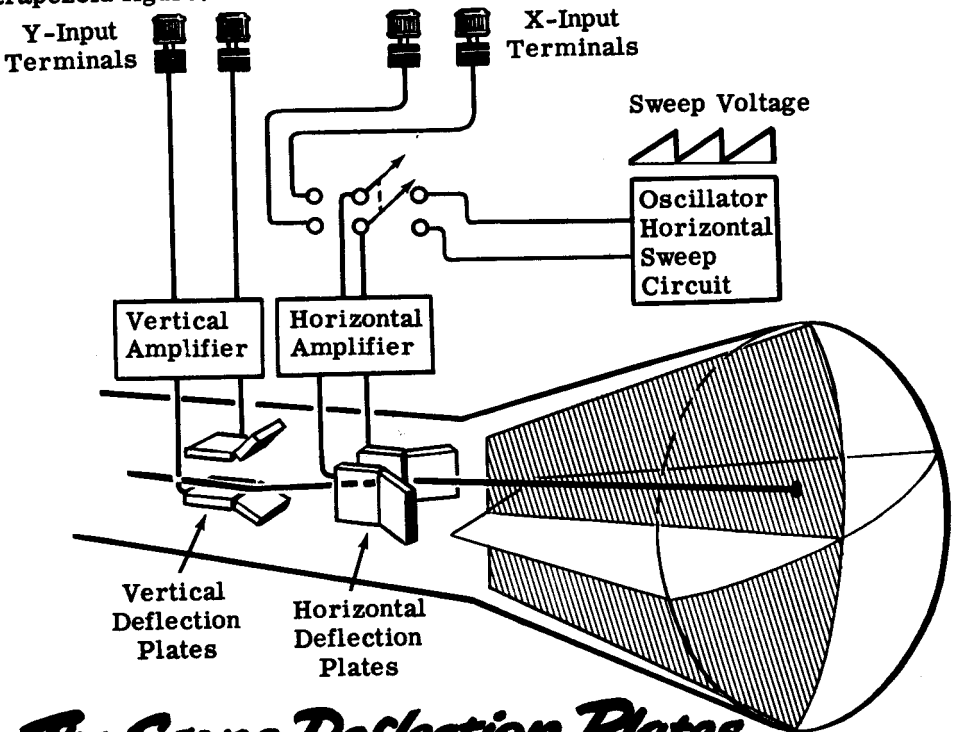

## *The Scope Deflection Plates*



## AMPLITUDE MODULATION

Trapezoid Figure (continued)

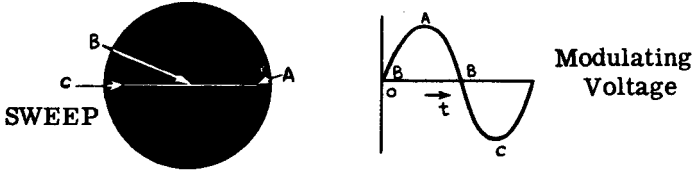

The trapezoid figure is produced in the following manner. When the modulating voltage is at its most negative value, the 'scope sweep (which is produced by the modulating voltage) will be at the left of the 'scope screen. As the modulating voltage increases to its most positive value, the electron beam will swing over to the right side of the screen (Point A). When the modulating voltage is at its most negative value, the spot will be on the left (Point C). If the modulating voltage were a perfect sine wave, the electron beam would be midway between the sides of the trapezoid figure (Point B) when the modulating voltage is zero. At any instant the position of the electron beam in the horizontal direction is a measure of how negative or positive the modulating voltage is.

At the same time that the electron beam is moved from one side of the screen to the other under the influence of the modulating voltage, the modulating voltage is causing the transmitter output to increase and decrease.

The transmitter output is applied to the 'scope to produce vertical deflections. When the modulating voltage is at its positive peak, the transmitter output and the height of the 'scope picture are greatest. Thus, the right side of the trapezoid figure shows the largest amplitude. When the modulating voltage is at its negative peak, the transmitter output and the height of the 'scope picture are at their minimum. This occurs when the electron beam is at the left side of the screen.

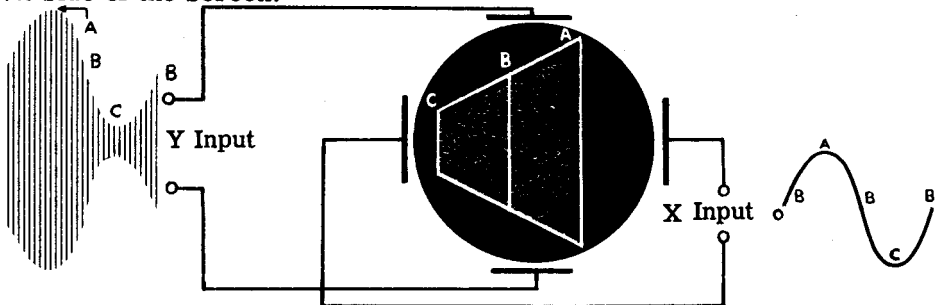
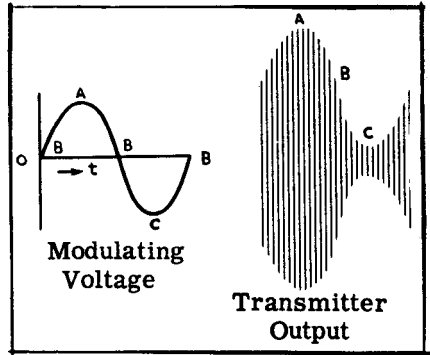

Because of the way in which trapezoid figures are obtained, they represent a graph of the output voltage as compared to the modulating voltage. If the output voltage is always proportional to the modulating voltage—as it will be when the modulation is linear—there will be a straight line along the top and on the bottom of the trapezoid.

# AMPLITUDE MODULATION

## Trapezoid Figure (continued)

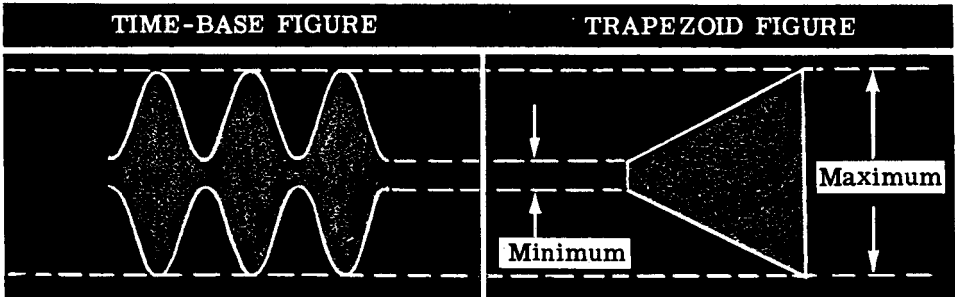

The two 'scope presentations shown above are for the same condition of modulation. You could determine the maximum height (peak) and the minimum height (trough or valley) of the RF from either figure. You could also determine the linearity of the modulation from either presentation, but it is easier to do so from the trapezoid.

If the modulating voltage is varied in amplitude, the peak and trough points on the time-base wave pattern come closer together. The same effect is seen in the trapezoid pattern as a decrease in the horizontal and vertical dimensions.

The following illustrations show both types of wave form presentation for three different modulating voltage amplitudes.

### EFFECT OF VARYING AMPLITUDE OF MODULATING VOLTAGE

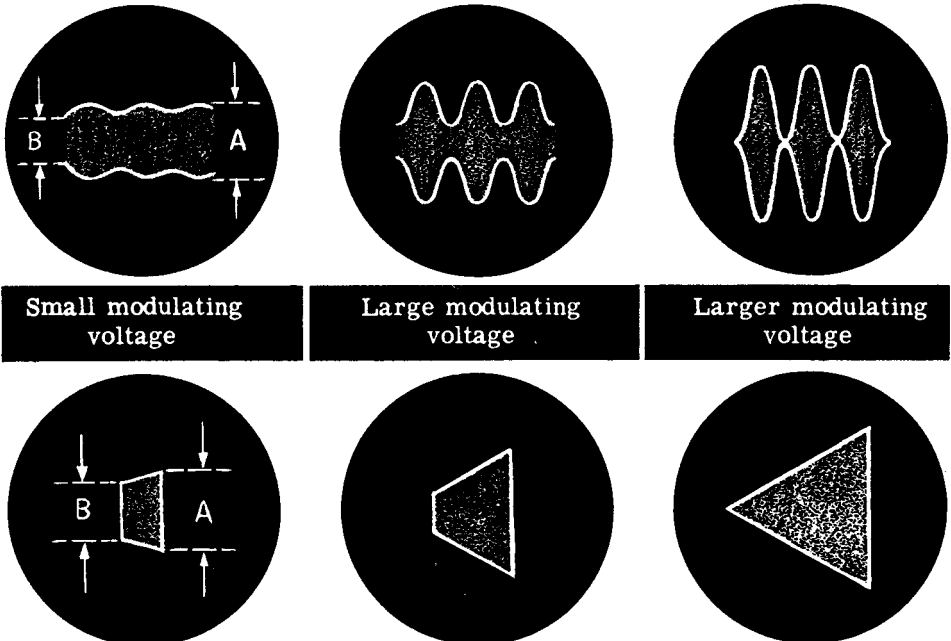

# AMPLITUDE MODULATION

## Percentage Modulation

The percentage modulation is a measure of the extent to which the carrier is modulated. If the carrier is modulated 100 percent, the maximum height of the modulated wave is twice that of the unmodulated wave and the minimum height is zero. The trapezoid figure is a triangle for this modulating condition. In voice communication the goal is always 100 percent modulation because the RF signal is then transmitted at maximum power.

*100% Modulation*

For maximum power in transmission, modulate 100%

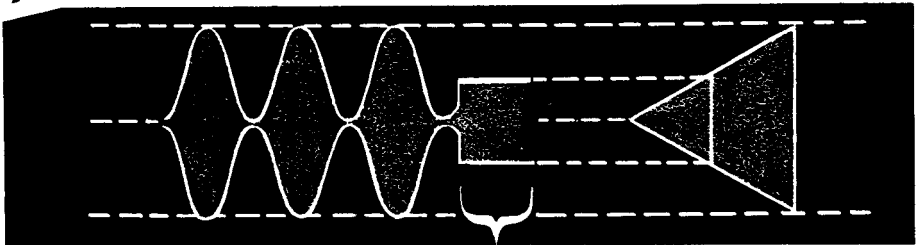

Unmodulated carrier

If the maximum height of the modulated wave is more than twice that of the unmodulated wave and the minimum height is zero for more than an instant during the cycle, the carrier is overmodulated. The percentage modulation is more than 100 percent. This condition is characterized by gaps in the time-base figure and a line extending from the left side of the triangle in the trapezoid figure. The more the wave is overmodulated, the longer are the gaps of the time-base figure and the longer the line in the trapezoid figure. Overmodulation is undesirable because it distorts the signal and generates unwanted sidebands which may interfere with adjacent carrier frequencies.

*Overmodulation*

distorts the signal and interferes with other carrier frequencies

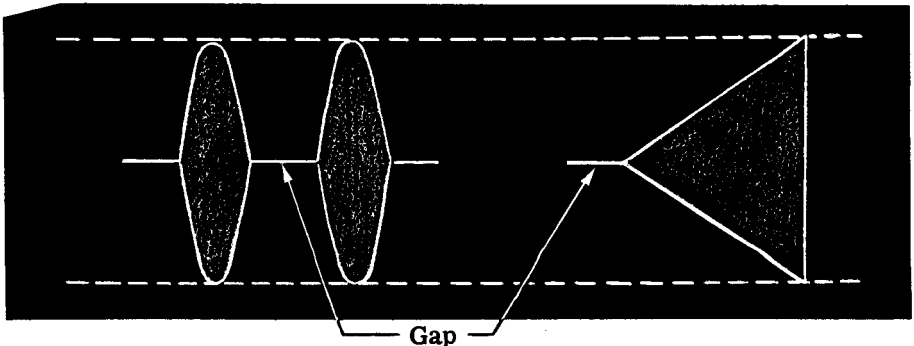

Gap

## AMPLITUDE MODULATION

### Percentage Modulation (continued)

Sometimes it is desirable to know the exact percentage of modulation. If the maximum height of the modulated wave is less than twice that of the unmodulated wave and the minimum height is more than zero, the percentage modulation is less than 100 percent. This is the most common condition. The exact percentage modulation can be calculated using the formula below.

$$\% \text{ modulation} = \frac{H \text{ max.} - H \text{ min.}}{H \text{ max.} + H \text{ min.}} \times 100$$

"H max." is the maximum height of the modulated wave and "H min." is the minimum height. These values can be measured from the 'scope pictures—the trapezoid figure is more convenient for this purpose but the time-base figure gives sufficiently accurate results.

In the figures below, H max. is 8 boxes and H min. is 2 boxes. The percentage modulation is:

# 60% modulation

$$\% \text{ modulation} = \frac{8 - 2}{8 + 2} \times 100 = \frac{6}{10} \times 100 = 60\%$$

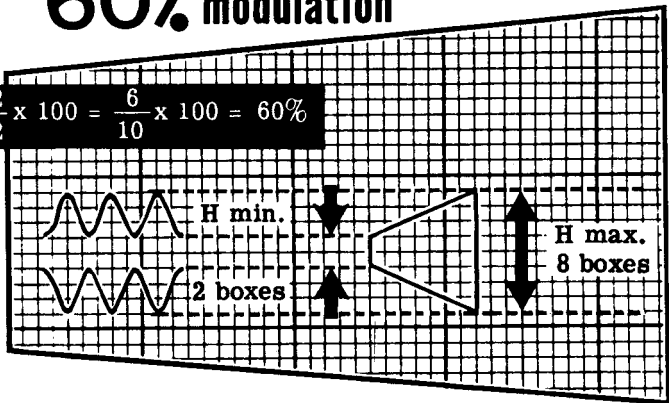

If H max. is 9 boxes and H min. is 1 box, the percentage modulation is:

# 80% modulation

$$\% \text{ modulation} = \frac{9 - 1}{9 + 1} \times 100 = \frac{8}{10} \times 100 = 80\%$$

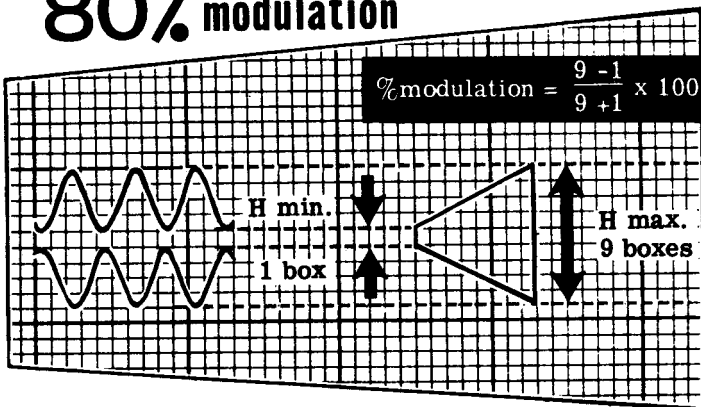

# AMPLITUDE MODULATION

## Review of Amplitude Modulation

### AMPLITUDE MODULATION—

The method which uses voice or an audio signal to vary the amplitude of an RF carrier wave. The modulator is the component of the AM transmitter which combines the audio and RF signals.

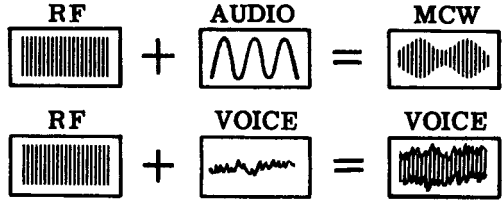

**SIDE BANDS**—Frequencies contained in the transmitted signal in addition to the RF carrier frequency. Sidebands are equal to the sum and difference of carrier and modulating signals. MCW has two sidebands; voice has many.

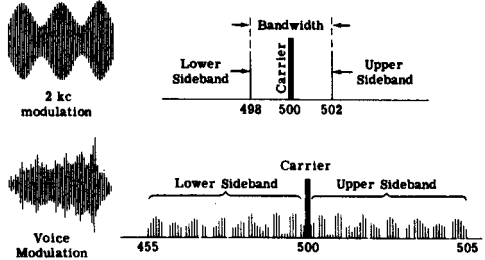

**PLATE MODULATION**—The method whereby the modulating signal varies the PA tube voltage, thus modulating its output in response to the audio signal.

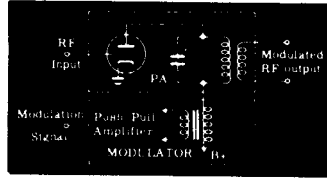

**GRID MODULATION**—The modulating signal is applied to the grid of the PA tube. Varying grid voltage in this manner controls PA tube plate current and hence modulates output voltage.

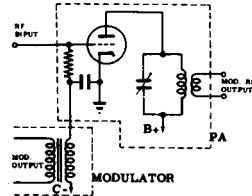

**TRAPEZOID FIGURE**—The oscilloscope pattern obtained by using the transmitter output voltage as 'scope's Y input, and the modulating signal as X input.

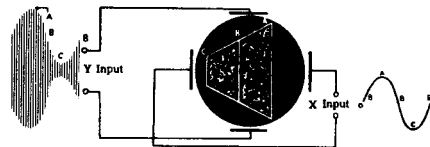

### PERCENTAGE MODULATION

—The measure of the extent to which the RF carrier is modulated. 100 percent modulation is desirable for voice transmission so that maximum power is transmitted. Overmodulation produces a distorted signal and introduces unwanted sidebands.

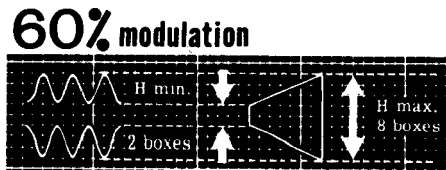

# TRANSMITTERS

## Review of Transmitters

Let's pause and review briefly what you have learned about transmitters.

**CW TRANSMISSION**—An RF signal is generated in the transmitter by an RF oscillator, and radiated into space. Intelligence is imparted by turning transmitter on and off with a key. CW is used most often for long distance communications.

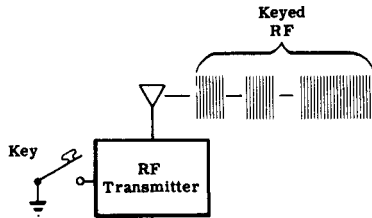

**MCW TRANSMISSION**—A constant amplitude audio frequency signal is superimposed on the RF carrier wave. Transmitter is turned on and off by means of a key as in CW transmission. MCW is used for emergency applications.

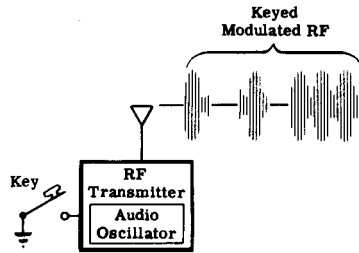

**VOICE TRANSMISSION**—In amplitude modulation a voice signal varies the amplitude of the RF carrier. Transmission is continuous, and is the type used for standard radio broadcasting.

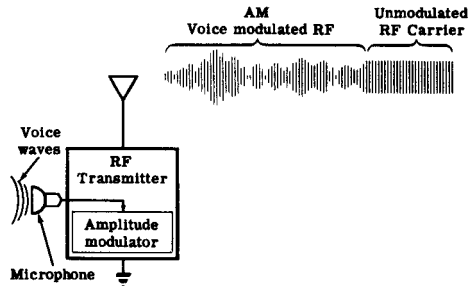

**GRID-LEAK BIAS**—A resistor and capacitor in the grid circuit of an amplifier tube to make the amplifier operate Class C. The amount of bias depends on the grid current, and varies as the strength of the input signal changes.

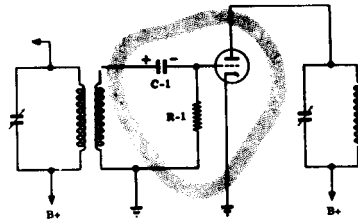

**COMBINATION BIAS**—A combination of fixed and grid-leak bias most commonly used in transmitters.

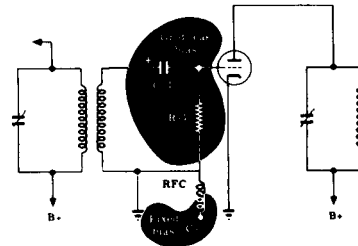

# TRANSMITTERS

## Review of Transmitters (continued)

**THREE-STAGE TRANSMITTER**—The master oscillator (MO), intermediate power amplifier (IPA) and final power amplifier (PA) make up the basic three-stage transmitter.

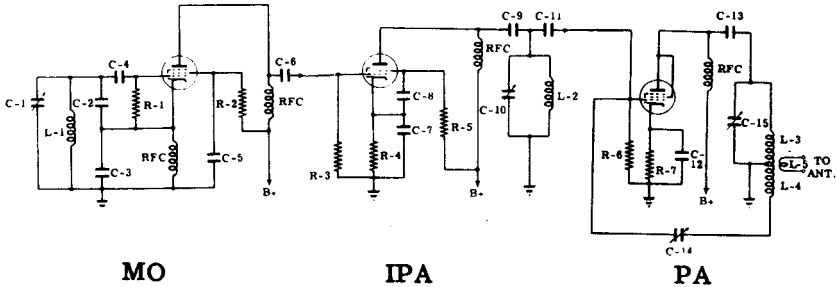

**TUNING**—For efficient operation, the plate tank circuit of the amplifiers must resonate at oscillator frequency. Adjusting the variable capacitor to reach this condition is called "tuning." Plate voltage is maximum and current minimum at signal frequency.

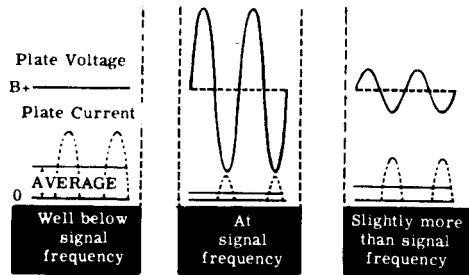

**NEUTRALIZATION**—Plate or grid neutralization circuits may be used to counteract the feedback effect at the grid-to-plate capacity of triodes used in transmitter amplifiers.

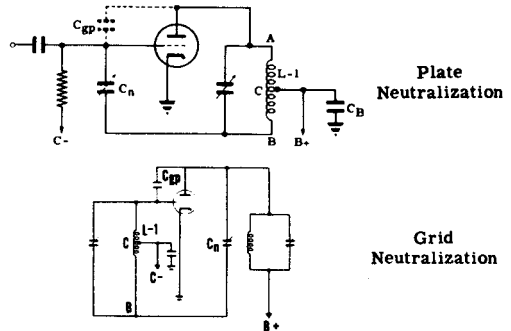

**TRANSMISSION LINE**—Used to convey the RF signal from the transmitter to the antenna. For maximum power output the characteristic impedance of the line should equal the input impedance of the antenna. Coupling circuits are used to couple the transmission line to the transmitter.

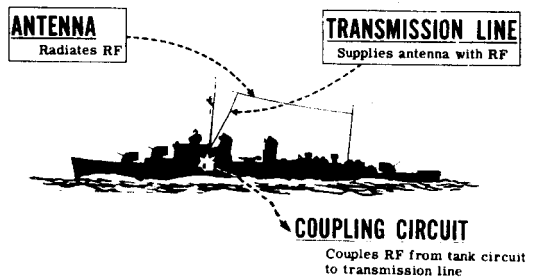

# TRANSMITTERS

## Review of Transmitters (continued)

**STANDING WAVES**—Voltage and current distribution along a transmission line or antenna can be represented by wave forms called "standing waves."

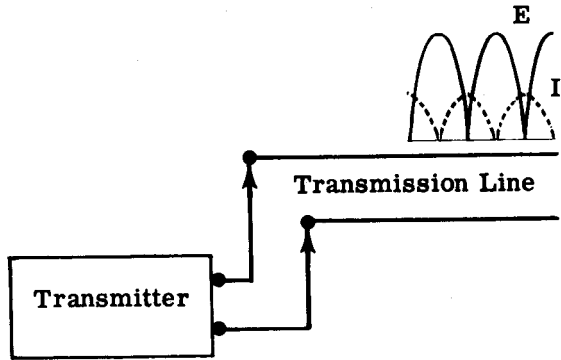

**ANTENNA**—Radiates energy, received from transmission line, into space. Electric and magnetic fields generated by current and voltage waves on antenna expand and collapse as transmitter signal varies.

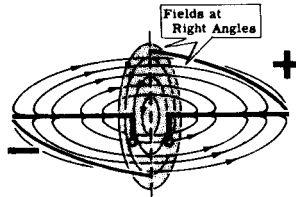

**SIDEBANDS**—Frequencies contained in the transmitted signal in addition to the RF carrier frequency. MCW has two sidebands; voice has many sidebands.

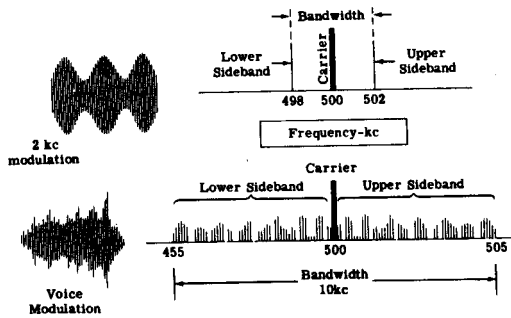

### PLATE MODULATION—

A method whereby the modulating signal varies the PA tube plate voltage, thus modulating its output in response to the audio signal.

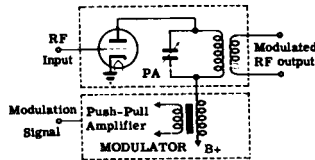

**GRID MODULATION**—The modulating signal is applied to the grid of the PA tube. Varying grid voltage in this manner controls PA tube plate current and hence modulates output voltage.

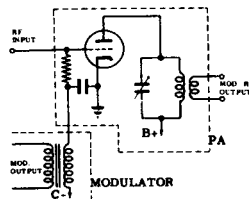



# INDEX TO VOL. 4

(Note: A cumulative index covering all five volumes in this series will be found at the end of Volume 5.)

- Amplifiers, review of classes of operation, 4-8
- Amplitude modulation, 4-85 to 4-99
  - percentage modulation, 4-97, 4-98
  - time base modulation pattern, 4-92
  - trapezoid figures, 4-93 to 4-96
  - what it is, 4-85
- Antennas, 4-63 to 4-79
  - basic, 4-66
  - fading, 4-73
  - ground wave, 4-72
  - how they work, 4-64, 4-65
  - impedance, 4-68
  - purpose of, 4-63
  - radiation pattern, 4-70
  - radiation resistance, 4-67
  - sky wave, 4-72
  - space wave, 4-73
  - tuning, 4-69
  - wave propagation, 4-71
- Class C amplifiers, 4-8 to 4-15
  - combination bias, 4-14
  - fixed bias, 4-11
  - self-bias, 4-12, 4-13
  - tuned, 4-9, 4-10
- Coupling circuits, 4-40
  - tuned, 4-41
- CW transmission, 4-80 to 4-84
  - advantages of, 4-80
  - blocked-grid keying, 4-83
  - cathode keying, 4-81, 4-82
  - keyer tube circuits, 4-84
- Demonstration, Current Distribution
  - Along an Antenna, 4-75
  - Radiation Pattern of an Antenna, 4-76 to 4-78
  - Transmission Lines, 4-57 to 4-61
- Frequency, 4-43
- Frequency doubling, 4-36
- Frequency measurement, using standing waves, 4-53
- Frequency multiplication, purpose of, 4-34
- Frequency multipliers, 4-34 to 4-38
  - final power amplifier, 4-35
  - tuning indications, 4-38
- Frequency spectrum, 4-74
- Frequency tripling, 4-37
- Modulation, grid, 4-90
  - how it is accomplished, 4-87
  - other methods of, 4-91
  - plate, 4-89
- Modulators, 4-88
- Review, A Three-Stage Transmitter, 4-33
  - Amplitude Modulation, 4-99
  - Antennas, 4-79
  - Class C Amplifiers, 4-15
  - Transmission Lines, 4-62
  - Transmitters, 4-100 to 4-102
- Sidebands, 4-86
- Three-stage transmitters, 4-16 to 4-33
  - complete diagram of, 4-21
  - intermediate power amplifier, 4-18
  - neutralization, 4-27 to 4-29
  - neutralizing procedures, 4-30, 4-31
  - oscillators, 4-17
  - parasitic oscillations, 4-32
  - power amplifier, 4-19
  - purpose of tuning, 4-22
  - three basic circuits, 4-16
  - transmitting tube filament circuit, 4-20
  - tuning methods, 4-23 to 4-26
- Transmission, AM, 4-6
  - FM, 4-6
  - keyed, 4-5
  - voice, 4-6
- Transmission lines, 4-39 to 4-62
  - characteristic impedance, 4-45
  - equivalent circuit of, 4-44
  - input impedance of a line, 4-50
  - input impedance of an open-circuited line, 4-52
  - input impedance of a short-circuited line, 4-51
  - line termination in characteristic impedance, 4-46
  - nonresonant and resonant lines, 4-47
  - open and shorted, 4-49
  - standing waves on a rope, 4-48
  - transferring electrical energy, 4-42
  - types of, 4-56
- Transmission line principles, applications of, 4-54, 4-55
- Transmitters, a simple type, 4-2 to 4-4
  - overall, 4-39
  - what they are, 4-1 to 4-7
- Wavelength, 4-43



## HOW THIS OUTSTANDING COURSE WAS DEVELOPED:

In the Spring of 1951, the Chief of Naval Personnel, seeking a streamlined, more efficient method of presenting Basic Electricity and Basic Electronics to the thousands of students in Navy speciality schools, called on the graphiological engineering firm of Van Valkenburgh, Nooger & Neville, Inc., to prepare such a course. This organization, specialists in the production of complete "packaged training programs," had broad experience serving industrial organizations requiring mass-training techniques.

These were the aims of the proposed project, which came to be known as the Common-Core program: to make Basic Electricity and Basic Electronics completely understandable to every Navy student, regardless of previous education; to enable the Navy to turn out trained technicians at a faster rate (cutting the *cost* of training as well as the time required) without sacrificing subject matter.

The firm met with electronics experts, educators, officers-in-charge of various Navy schools and, with the Chief of Naval Personnel, created a dynamic new training course . . . completely up-to-date . . . with heavy emphasis on the visual approach.

First established in selected Navy schools in April, 1953, the training course comprising Basic Electricity and Basic Electronics was such a tremendous success that it is now the *backbone* of the Navy's *current* electricity and electronics training program!\*

The course presents one fundamental topic at a time, taken up in the order of need, rendered absolutely understandable, and hammered home by the use of clear, cartoon-type illustrations. These illustrations are the most effective ever presented. *Every page has at least one such illustration—every page covers one complete idea!* An imaginary instructor stands figuratively at the reader's elbow, doing demonstrations that make it easier to understand each subject presented in the course.

Now, for the first time, Basic Electricity and Basic Electronics have been released by the Navy for civilian use. While the course was *originally* designed for the Navy, the concepts are so broad, the presentation so clear—*without* reference to specific Navy equipment—that it is ideal for use by schools, industrial training programs, or home study. *There is no finer training material!*

"Basic Electronics" consists of *five* volumes, as follows: *Vol. 1*—Introduction to Electronics, Diode Vacuum Tubes, Dry Metal Rectifiers, What a Power Supply Is, Filters, Voltage Regulators. *Vol. 2*—Introduction to Amplifiers, The Triode Tube, Tetrodes & Pentodes, Audio Voltage & Power Amplifiers. *Vol. 3*—Video Amplifiers, RF Amplifiers, Oscillators. *Vol. 4*—Transmitters, Transmission Lines & Antennas, CW Transmission & Amplitude Modulation. *Vol. 5*—Receiver Antennas, Detectors & Mixers, TRF Receivers, Superheterodyne Receivers.

\*"Basic Electricity," the first portion of this course, is available as a separate series of volumes.

**JOHN F. RIDER PUBLISHER, INC., 116 WEST 14th ST., N. Y. 11, N. Y.**



No. 170-5

# basic electronics

by **VAN VALKENBURGH,  
NOOGER & NEVILLE, INC.**

**VOL. 5**

RECEIVER ANTENNAS  
DETECTORS & MIXERS  
TRF RECEIVERS  
SUPERHETERODYNE RECEIVERS

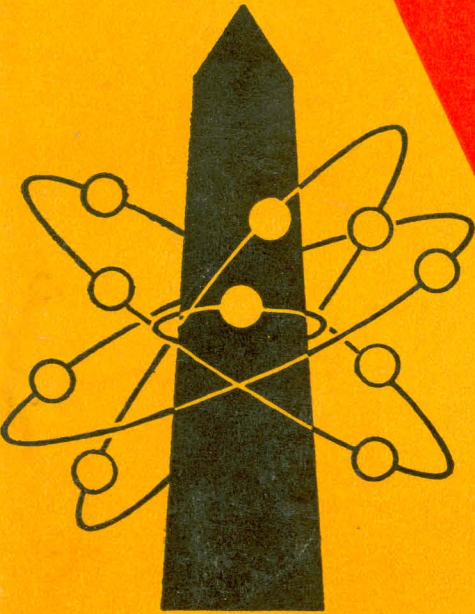

A. STICH

a **RIDER** publication

\$2.25

# **basic electronics**

**by VAN VALKENBURGH,  
NOOGER & NEVILLE, INC.**

**VOL.5**



**JOHN F. RIDER PUBLISHER, INC.**  
116 West 14th Street • New York 11, N. Y.

**First Edition**

*Copyright 1955 by*

**VAN VALKENBURGH, NOOGER AND NEVILLE, INC.**

All Rights Reserved under International and Pan American Conventions. This book or parts thereof may not be reproduced in any form or in any language without permission of the copyright owner.

*Library of Congress Catalog Card No. 55-6984*

**Printed in the United States of America**

## PREFACE

The texts of the entire Basic Electricity and Basic Electronics courses, as currently taught at Navy specialty schools, have now been released by the Navy for civilian use. This educational program has been an unqualified success. Since April, 1953, when it was first installed, over 25,000 Navy trainees have benefited by this instruction and the results have been outstanding.

The unique simplification of an ordinarily complex subject, the exceptional clarity of illustrations and text, and the plan of presenting one basic concept at a time, without involving complicated mathematics, all combine in making this course a better and quicker way to teach and learn basic electricity and electronics.

In releasing this material to the general public, the Navy hopes to provide the means for creating a nation-wide pool of pre-trained technicians, upon whom the Armed Forces could call in time of national emergency, without the need for precious weeks and months of schooling.

Perhaps of greater importance is the Navy's hope that through the release of this course, a direct contribution will be made toward increasing the technical knowledge of men and women throughout the country, as a step in making and keeping America strong.

*Van Valkenburgh, Nooger and Neville, Inc.*

*New York, N. Y.*

*February, 1955*





## TABLE OF CONTENTS

### VOL. 5 — BASIC ELECTRONICS

Introduction to Receivers . . . . .	5-1
Receiver Antennas . . . . .	5-16
TRF Receivers — RF Amplifier Stage . . . . .	5-24
TRF Receivers — Audio Amplifier Stage . . . . .	5-33
TRF Receivers — Regenerative Detector . . . . .	5-38
TRF Receivers — Plate Detector . . . . .	5-54
The Superheterodyne Receiver . . . . .	5-57
Troubleshooting the Superheterodyne Receiver . . . . .	5-89



# INTRODUCTION TO RECEIVERS

## History of Communication

Did it ever occur to you to ask, "Why is there such a thing as a radio receiver?" To answer this question, you have to know something about the history of man's attempt to improve his methods of communication.

Since the earliest days, man has always tried to increase the distance over which he could send messages.



## INTRODUCTION TO RECEIVERS

### History of Communication (continued)

Since the dawn of history, good communications have played an important part in the art of warfare. The victory message of the Battle of Marathon carried by a Greek runner was one of the earliest recorded instances of battle communications. Our own history offers another famous example in Paul Revere's ride.

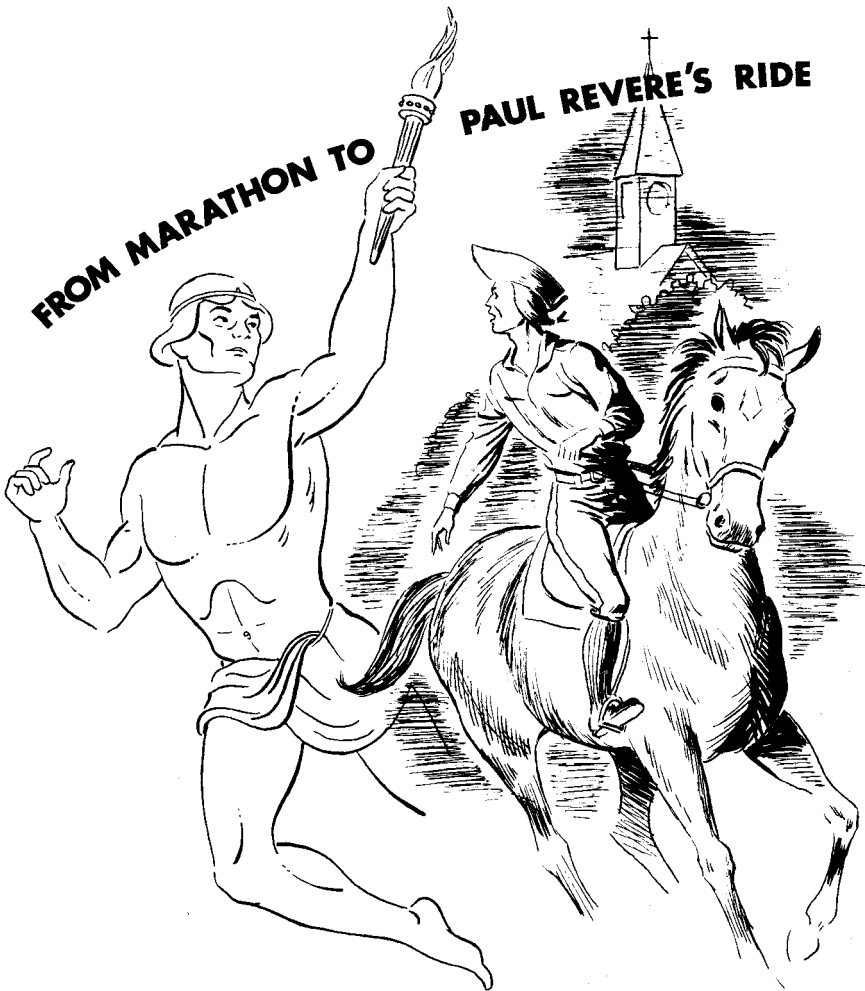

## GOOD COMMUNICATIONS HAVE WON BATTLES

A result of poor communications was effectively demonstrated in the Battle of New Orleans during the War of 1812. Because news of the cessation of hostilities did not reach those in command until it was too late, this battle was fought several days after the war had ended.

# INTRODUCTION TO RECEIVERS

## History of Communication (continued)

Some of the more primitive methods of communication—human messengers and homing pigeons—have limited application. Today we still use semaphore signals and interrupted flashes of light to convey messages. Colored lights, rockets and flares perform functions similar to those of the warning hilltop fires of old, while whistles and sirens are still being used.

SOME **MODERN** VERSIONS OF  
**PRIMITIVE** METHODS ARE

STILL IN USE.....

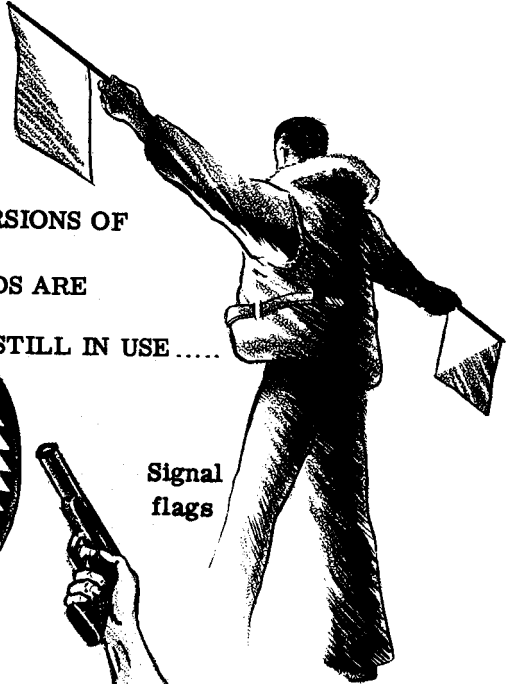

Signal  
flags

Flares or Rockets

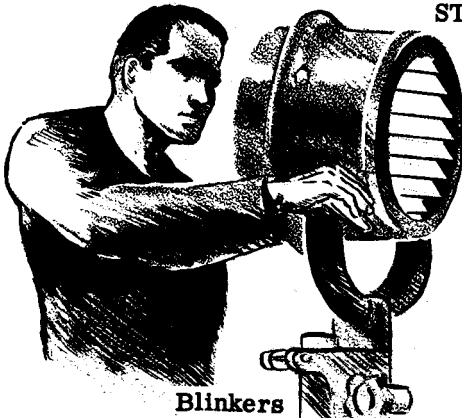

Blinkers



Sirens



## INTRODUCTION TO RECEIVERS

### History of Communication (continued)

These simple signaling systems are at best slow and unreliable. If the wind is blowing from the wrong direction, sound signals will not be received. In thick fog or heavy rain, visual signals fail to deliver the message. Runners and pigeons are slightly more reliable, but their rate of travel is relatively slow.

The problem of rapid and reliable communication was solved by harnessing electricity to the task. Improvements on the inventions of Morse, Bell and Marconi have led to the development of modern telegraph, telephone and wireless communication systems capable of transmitting messages almost instantaneously over thousands of miles of space.

ELECTRICITY MADE COMMUNICATIONS RELIABLE AND RAPID

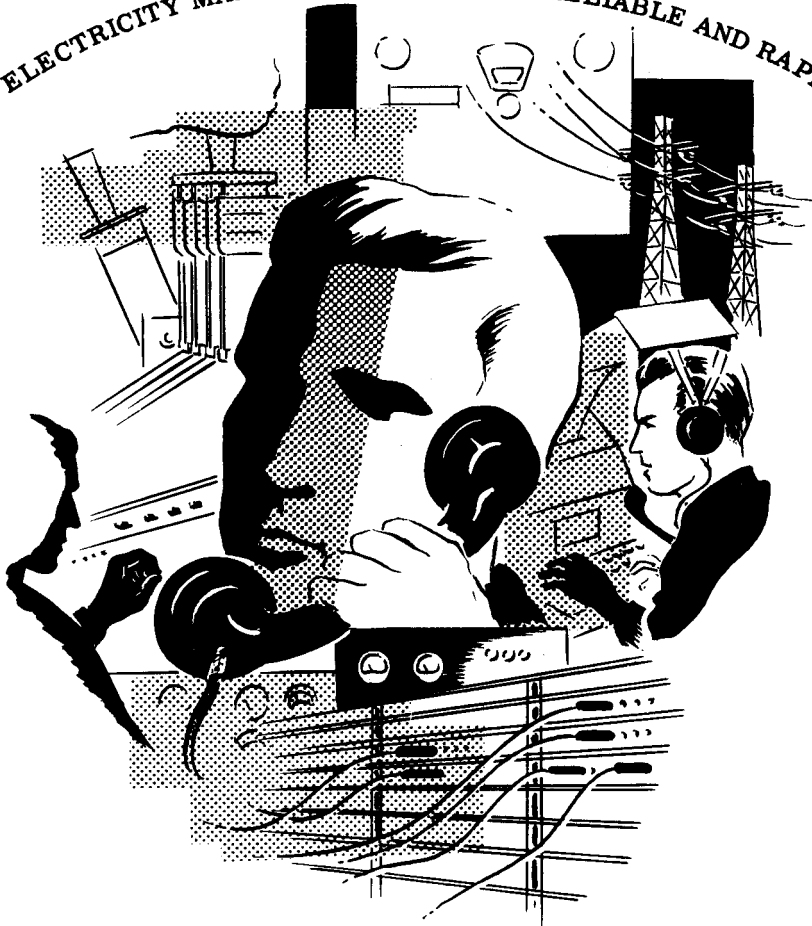

## INTRODUCTION TO RECEIVERS

Modern Wireless Communication

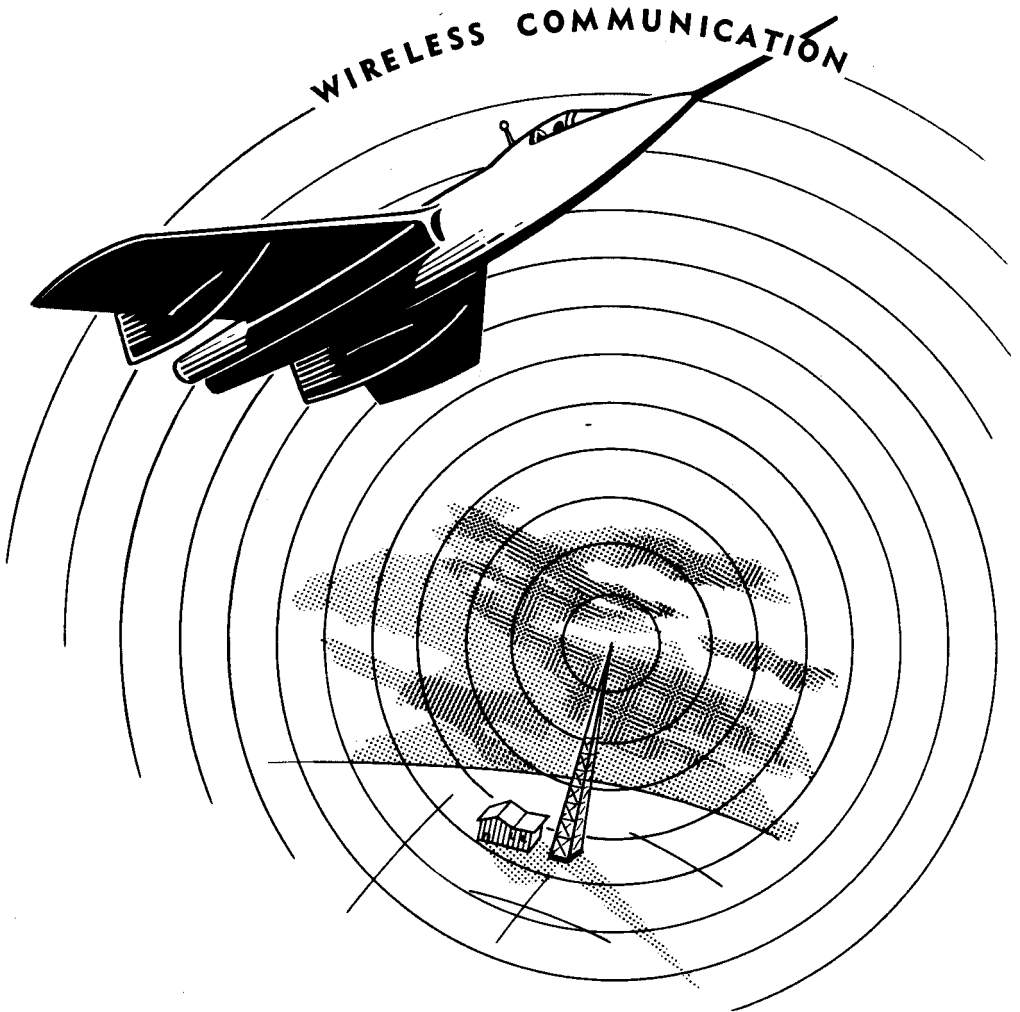

Today, with the advent of wireless communication, or as it is more commonly known—radio communication, the use of electricity for transmitting messages has reached its highest point. No longer is transmission limited to those places which a wire can reach, as is the case with telephone.

This remarkable electronic device, the radio, consists of two parts—the transmitter and the receiver. The transmitter sends out the message, in the form of radio waves, into the atmosphere. The radio receiver picks up the radio waves sent out by the transmitter, and converts them into the message which was originally put into the transmitter. This section will deal with the receiving end of radio communication—the receiver.

# INTRODUCTION TO RECEIVERS

## The Jobs a Receiver Performs

The jobs that a receiver must perform are very much the same in radio, radar and sonar equipment. Both the type of signal going into the receiver and the type of signal coming out of the receiver are different for each type of equipment; but the steps the incoming signal must go through before it emerges as a useful output are almost identical, whether the receiver is used for radio, radar or sonar. The function of any receiver can be broken down into five separate steps.

1. Picking up incoming signals: In radio and radar, the incoming signals are electromagnetic carrier waves sent out by a transmitter. When these waves cut across the receiving antenna, a very weak current is caused to flow. The current varies in frequency and amplitude to duplicate the signal radiated from the transmitter antenna.

In sonar, the "antenna" is an underwater microphone called a "transducer" which converts the incoming signal to a weak current flow and serves the same purpose as the radio and radar antennas.

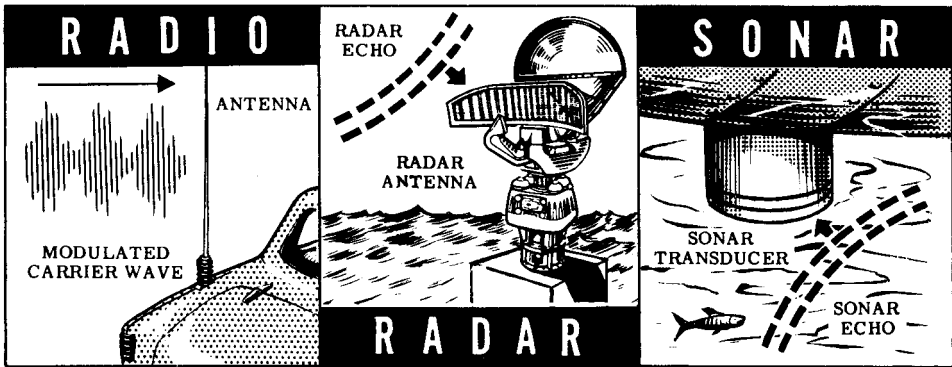

2. Selecting the desired signal: Many transmitters are sending out signals that reach the receiver antenna, and of these many signals, the receiver must be able to select the desired one. Each transmitter uses a different frequency, while the receiver contains circuits tuned to only the frequency that the operator desires to receive. The more tuned circuits used, the sharper the tuning. By tuning these circuits to the frequency of the signal of one of the transmitters, you can select that desired signal and reject all other signals.

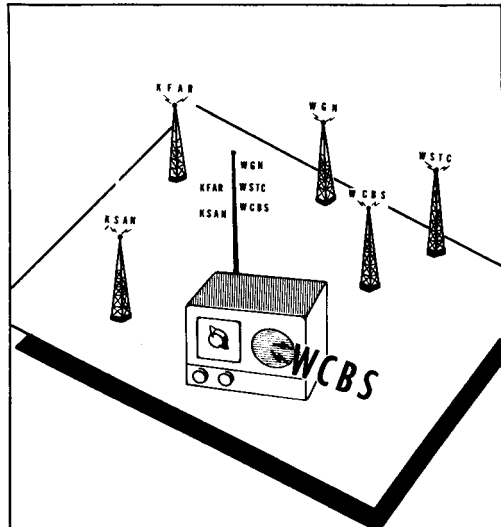



## INTRODUCTION TO RECEIVERS

### The Jobs a Receiver Performs (continued)

3. **Amplifying the desired RF signal:** The currents generated by the incoming signals in the antenna or transducer are extremely weak. RF amplifiers similar to those you have already studied are used to amplify these weak signals before they reach the detector.
4. **Detecting or demodulating the amplified signal:** A detector stage follows the last RF amplifier in a receiver. The detector does the important job of separating the "envelope" of the signal from the RF carrier. Because the envelope is the modulation of the signal, a detector is sometimes called a "demodulator." The signal, after demodulation, may be a voice or code signal as in communications radio receivers, or a sharp voltage rise and fall as in radar or sonar receivers.
5. **Amplifying the audio or video signals:** In radio receivers, the audio signal which comes from the detector undergoes further amplification. Audio voltage amplifiers and power amplifiers, similar to those you have already studied, build up the audio signal enough to operate a pair of earphones or a loudspeaker so that the signal may be heard.

In some sonar sets, the signal is heard in a loudspeaker, and the receiver is similar in design and operation to a radio receiver. In radar and certain other types of sonar receivers, the signal will show up as a "pip" on a 'scope. In these receivers, a video amplifier similar to those you have already learned about, would be used to amplify the voltage "pips." The video amplifiers take the signal from the detector and build it up so that it can be seen on the radar or sonar 'scope.

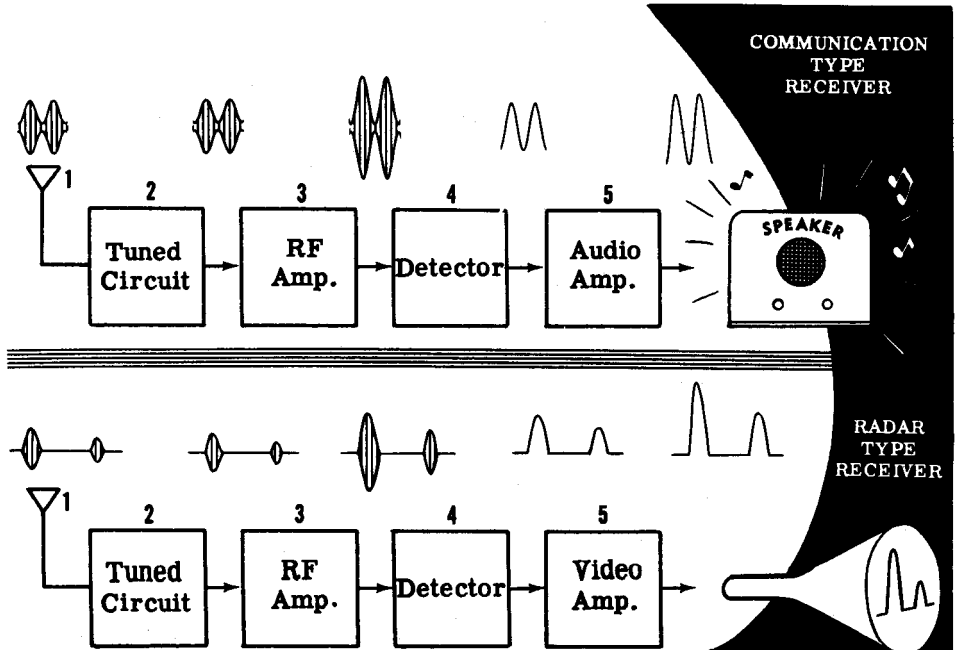

# INTRODUCTION TO RECEIVERS

## Receiver Sensitivity

There are several characteristics of a receiver which you can determine by simply comparing the input signal and the receiver output. These characteristics will tell you how well your receiver is working. The first of the characteristics—there are three in all—is sensitivity.

Sensitivity can be defined as the ability of the receiver to pick up weak signals, amplify them and deliver a useful output. No matter what type of equipment the receiver is in, sensitivity is important because many input signals which the receiver must amplify are extremely weak. Only a sensitive receiver can develop a sizable output with a weak input.

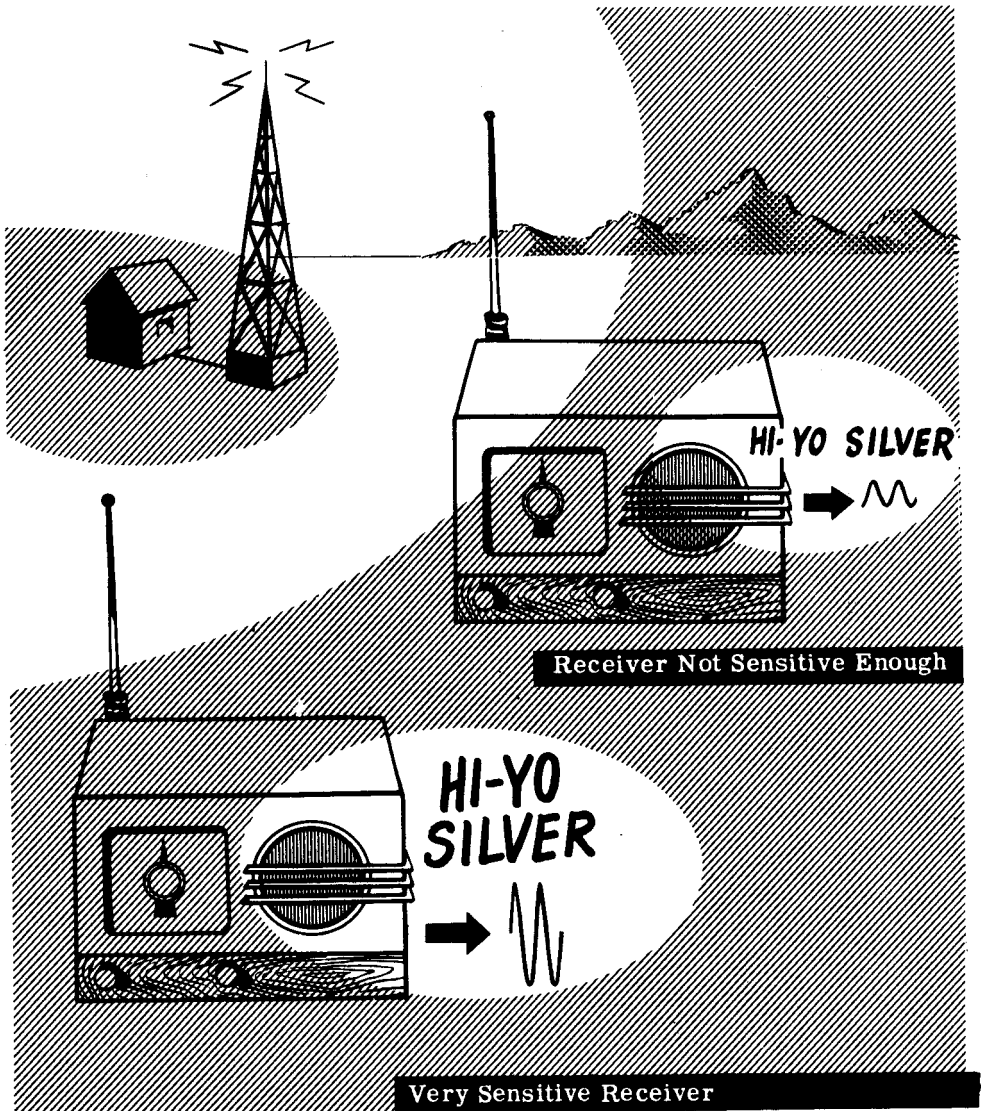

# INTRODUCTION TO RECEIVERS

## Receiver Selectivity

Sensitivity, by itself, does not make a receiver good enough for use. It must also be selective.

Selectivity is the ability of a receiver to select a desired signal and discriminate against all undesired signals. If every signal which struck the antenna were amplified, the output, although strong enough, would be worthless because of all the interference caused by the presence of the undesired signals.

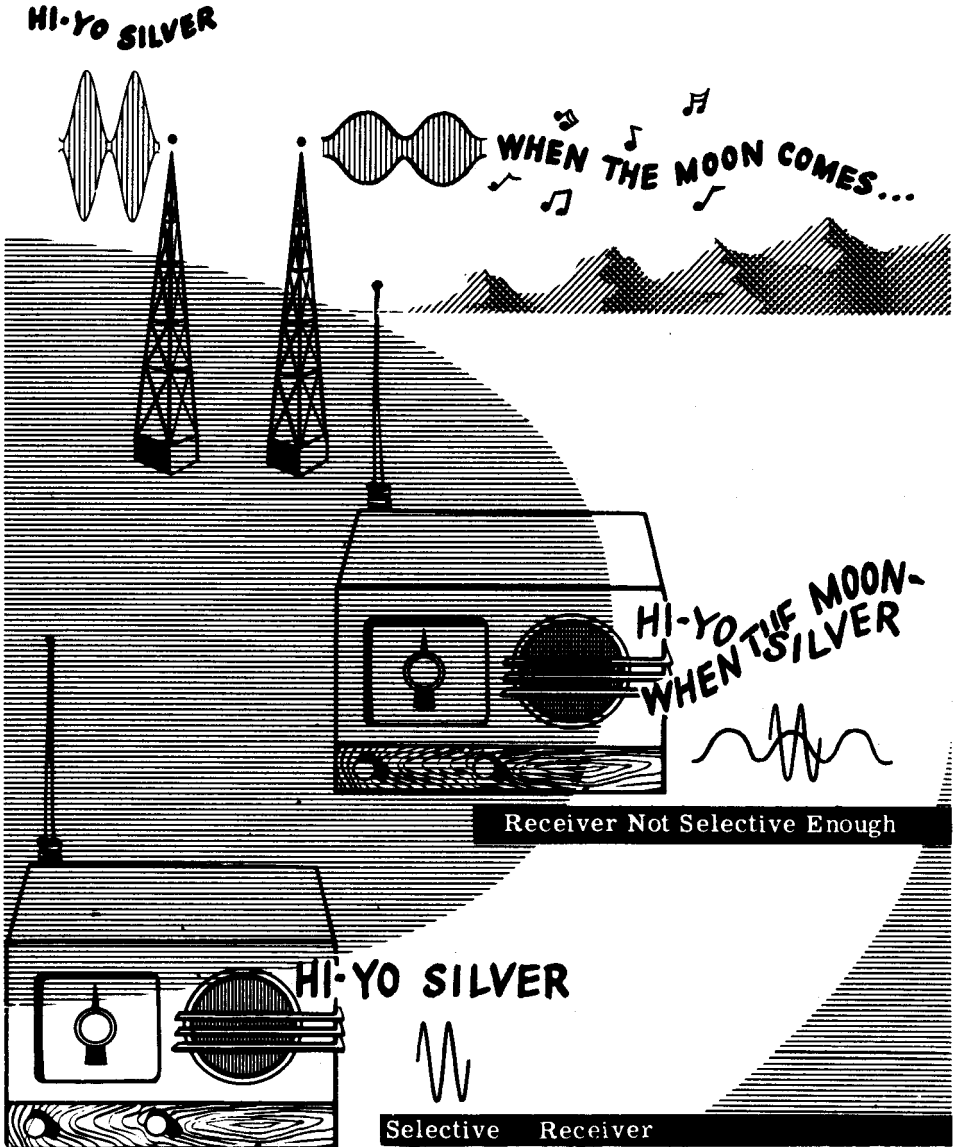

# INTRODUCTION TO RECEIVERS

## Fidelity

For some applications, if the receiver can pick out one signal from the many which strike the antenna (selectivity) and can amplify it so as to produce a useful output even though the signal may be weak (sensitivity), the receiver is good enough to be used. For other applications, one more thing is important—the receiver must be able to reproduce the incoming signal without distortion. A receiver which can do this is said to have "good fidelity"; a receiver which cannot, has "poor fidelity."

Home radio receivers usually have good fidelity since they are made for enjoyment. Communications receivers are made to duplicate voice, but only so that it is intelligible, and are therefore not usually designed with good fidelity in mind. Sonar and radar receivers, on the other hand, have good fidelity because the operator gets a great deal of information from the sound or 'scope appearance of the receiver output.



## The Crystal Receiver

The first receivers were used in the early 1900's and were called "crystal sets." In their simplest form, they consisted of an antenna, a crystal detector, a "cat's whisker" and a pair of earphones.

The antenna picked up any signals in the air—in those days there were very few—and the crystal (which operated as a rectifier) allowed the antenna currents to flow directly to ground on every positive half cycle of RF, but blocked the negative half cycles. These positive half cycles of current flowed through the "cat's whisker," a delicate wire contact on the crystal, to the earphones where weak sounds sometimes were heard. Crystal sets at best had one tuned circuit before the crystal, but even so, the selectivity was very poor. Because no vacuum tubes were used, the sensitivity was so bad that crystal sets could not be used very far from a transmitting station. Today these sets are curiosities, and have no practical applications.

# IN THE BEGINNING...

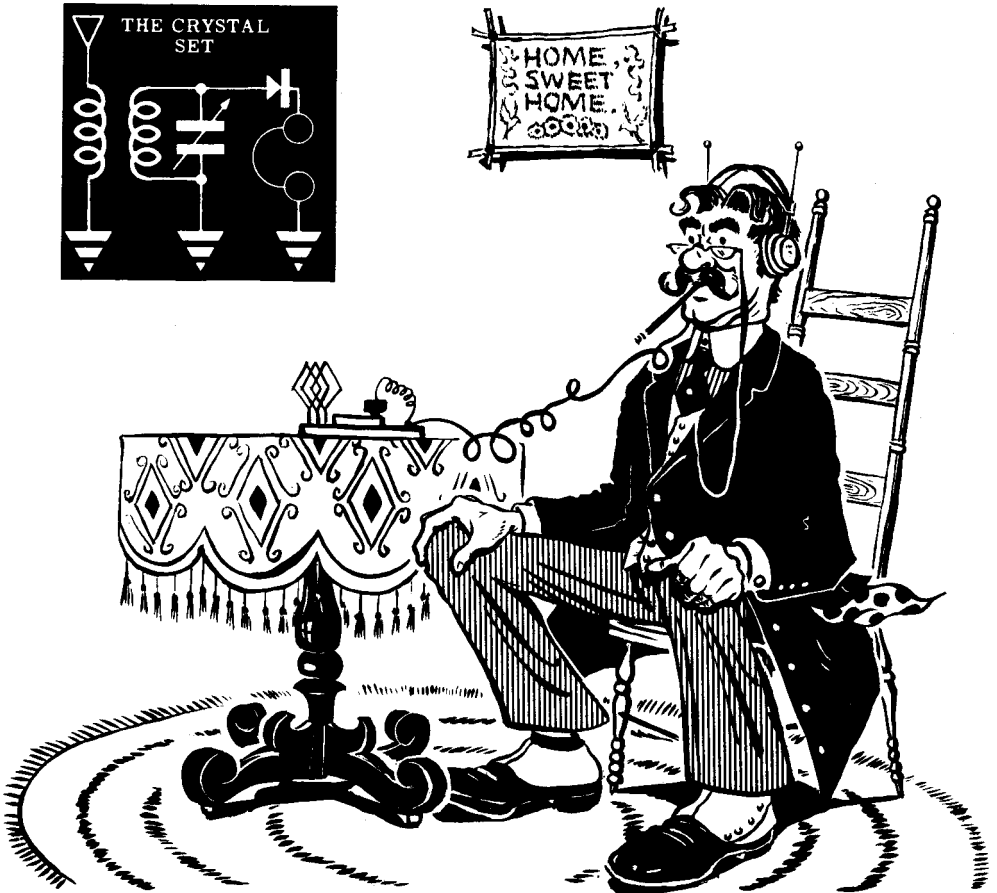
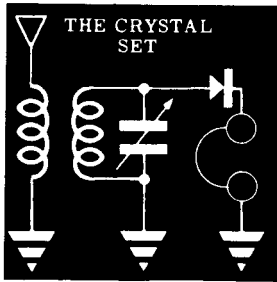

## The TRF Receiver

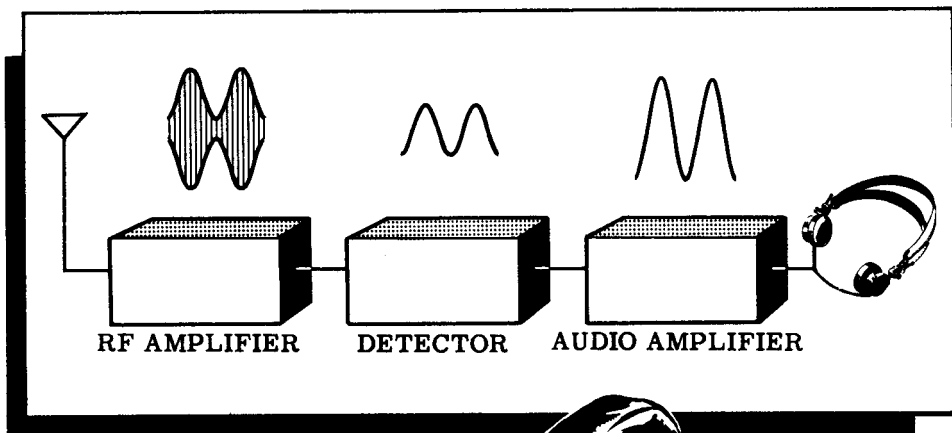

TRF

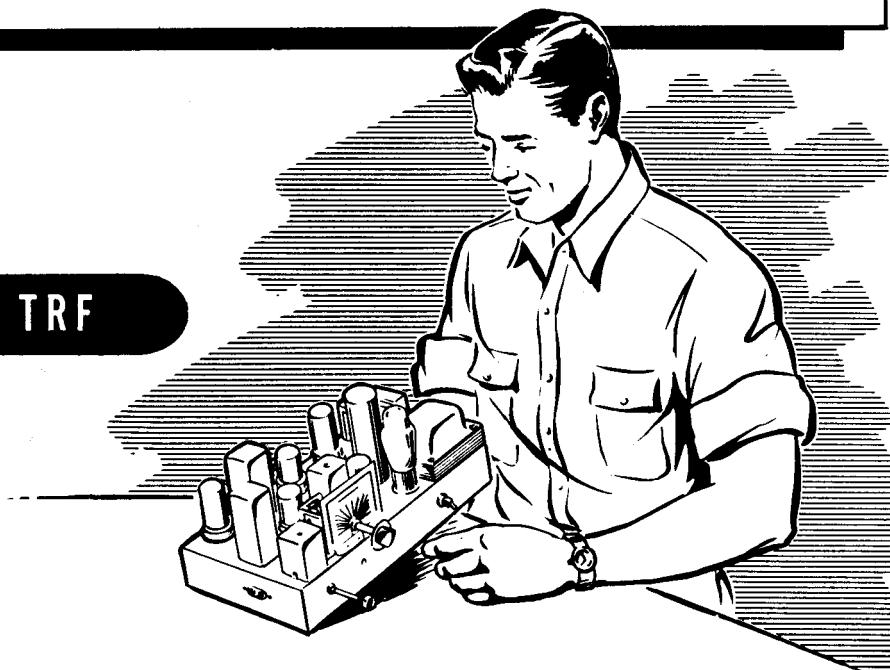

By 1920, crystal sets were on their way out and were being replaced by tuned radio frequency (TRF) receivers, which made use of vacuum tubes. The first few vacuum tubes, and their tuned circuits, make up the RF amplifier which gives the TRF receiver better selectivity and sensitivity than the old crystal sets. The detector does the same thing as the crystal detector and sometimes amplifies the signal as well. After the detector, the audio signal is amplified in the audio amplifier. The output of the audio amplifier is a fairly powerful signal which can be used to drive a loud-speaker or a pair of earphones. TRF receivers are not used very often today, but some receivers are still of this type.

## INTRODUCTION TO RECEIVERS

### The Superheterodyne Receiver

The most common type of receiver used in home radios and in other equipment is the superheterodyne receiver. In this type of receiver, all the RF amplification does not take place at the incoming signal frequency. Most of the RF amplification occurs after the incoming signal has been converted to an intermediate frequency (IF), which is always the same no matter what the frequency of the desired signal is. You will see how this is accomplished later.

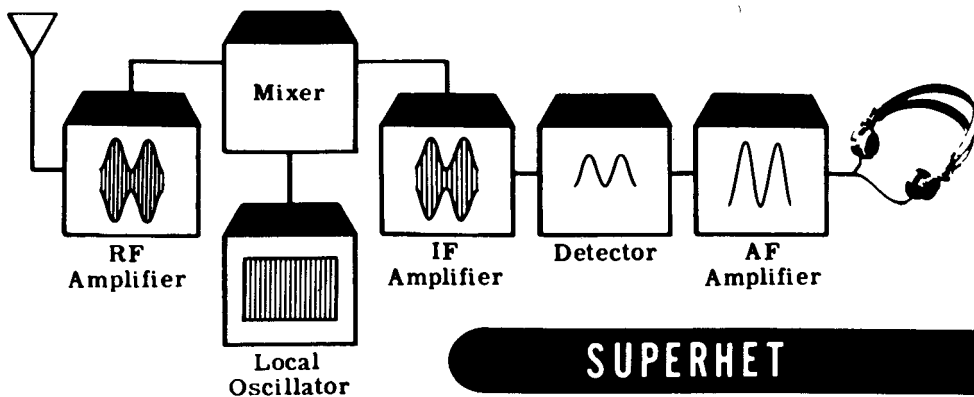

The only parts in a superhet which differ from those in a TRF are the variable frequency local oscillator, the mixer and the IF amplifier. The variable frequency local oscillator is similar to the oscillators with which you have already worked. The oscillator produces a pure RF signal which is "mixed" in the mixer stage with the signal from the RF amplifier. The resulting IF frequency is the difference between the input signal frequency and the local oscillator frequency. The IF is a fixed frequency and the IF amplifiers are therefore fixed-tuned. This allows them to be very accurately tuned so that high gain and selectivity can be obtained at the chosen frequency.

You will find out exactly how a superhet receiver works a little later in this section. For the time being, it is enough for you to know that the advantage of the superhet over the TRF receiver is that the superhet has higher gain and greater selectivity.

# INTRODUCTION TO RECEIVERS

## Recently Developed Uses of Receivers

Receivers play a very important role in the relatively new field of television, which finds wide application both in the civilian and military field.

Every home television set has at least two receivers. One receiver is designed to change part of the incoming signal into sound, while the other converts the remainder of the signal into a picture or image which appears on a screen.

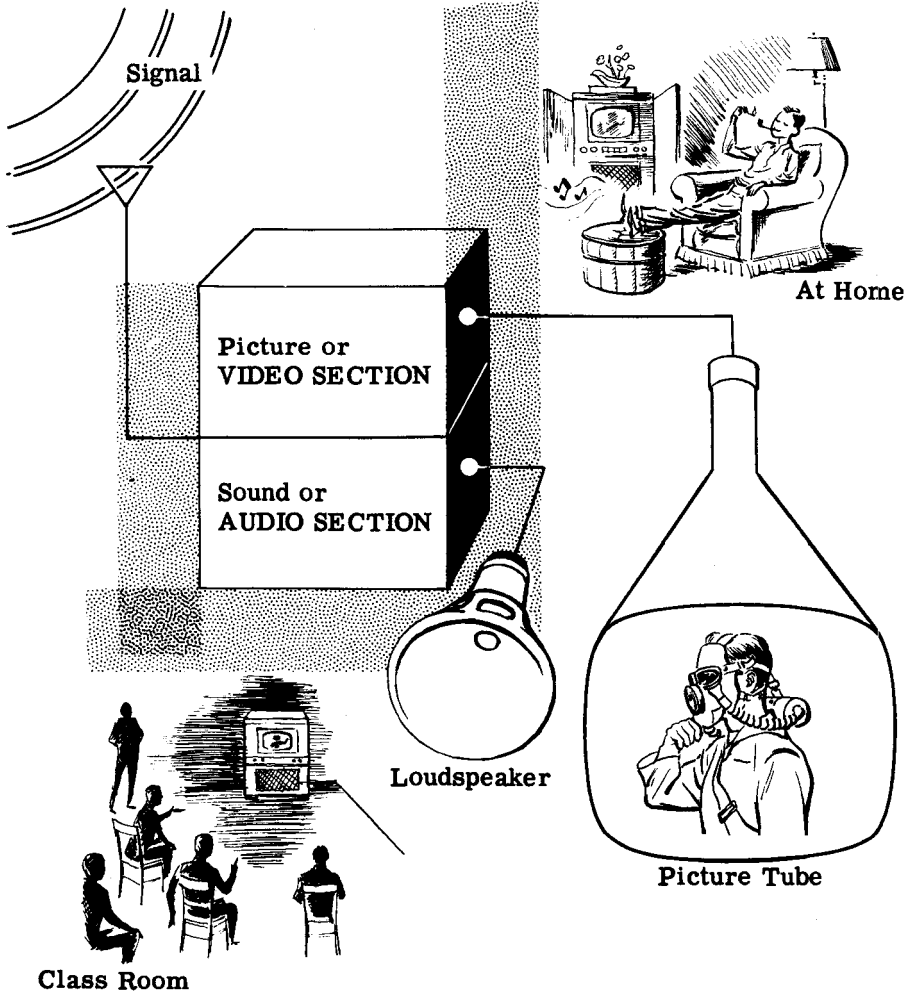

We are all aware of television as a source of entertainment. Another application, designed for improving and enriching training programs, involves the use of televised demonstrations. These demonstrations may be observed simultaneously in dozens of classrooms.



## INTRODUCTION TO RECEIVERS

### Recently Developed Uses of Receivers (continued)

Airborne television equipment can be used to transmit an overall survey of localized operations back to a flagship or to headquarters.

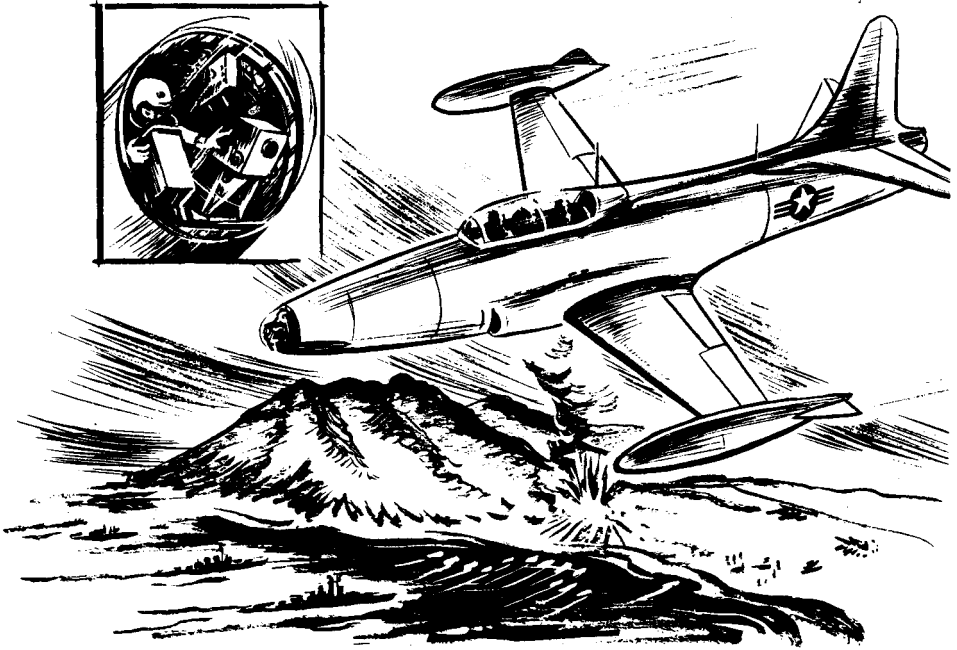

One of the most interesting and significant applications of radio reception to modern warfare is in connection with the development of guided missiles. The path followed by these missiles can be controlled by radio signals transmitted by a distant operator.

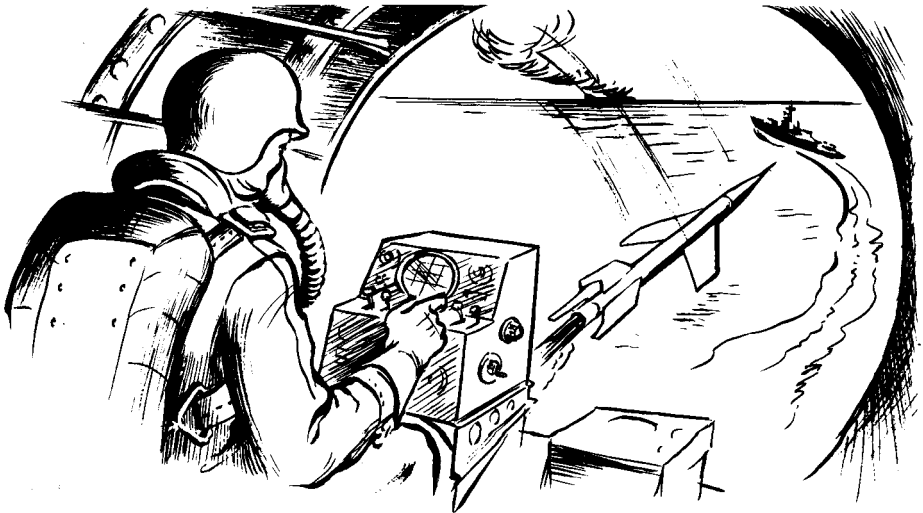

## RECEIVER ANTENNAS

### The Function of Receiver Antennas

The purpose of the receiver antenna is to intercept the electromagnetic waves radiated from the transmitter. When these waves cut across the antenna, they generate a small voltage in it. This voltage causes a weak current to flow in the antenna-ground system. This feeble current has the same frequency as the current in the transmitter. If the original current in the transmitter is amplitude modulated, the antenna current will vary in exactly the same manner. This weak antenna current, flowing through the antenna coil, induces a corresponding signal in the grid circuit of the first RF amplifier stage of the receiver.

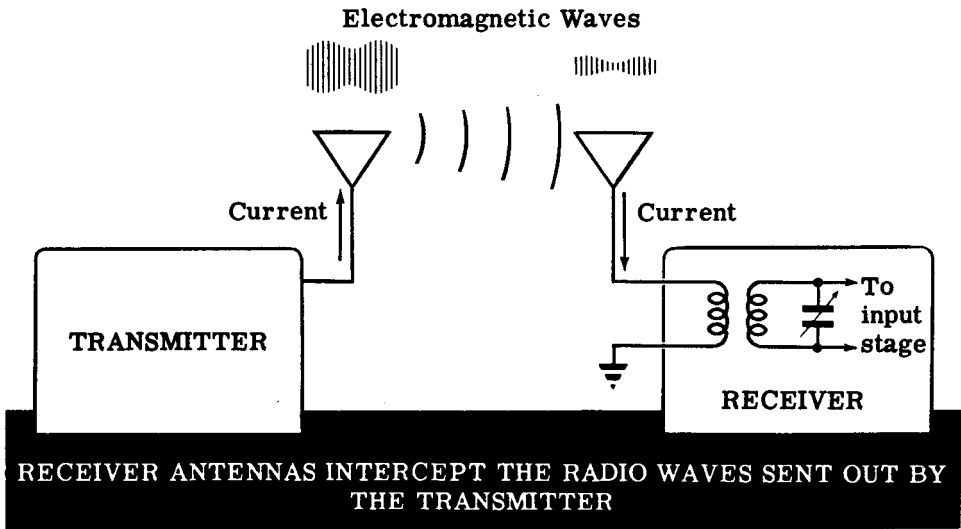

A receiving antenna should feed as much signal and as small an amount of undesired interference to the receiver as possible. It should be constructed so that the signal is not lost or dissipated before reaching the receiver. It should give maximum response for the frequency or band of frequencies to which the receiver is tuned. An antenna can also be directional, which means that it will give best response in the direction from which the operator wishes to receive.

The receiver antenna problem is easily solved when the receiver is operated in conjunction with a transmitter. Since the transmitting antenna is usually designed to incorporate the desirable features which have just been listed, the same antenna is used for both transmitter and receiver. A switch or relay is used to connect the antenna to the piece of equipment that is operating at that particular moment. However, when no transmitter antenna is available it may be necessary to erect a separate receiving antenna, paying attention to the four considerations of noise, signal loss, frequency response and directivity. Before discussing these considerations of antenna design, it might be a good idea to become familiar with a few of the more common types of receiving antennas.

## RECEIVER ANTENNAS

### Types of Receiver Antennas

One of the simplest and most commonly used antennas is the inverted L. It consists of a wire, known as a "flat-top," which is suspended horizontally between two insulators. The length of the wire should be from 50 to 75 feet for broadcast-band reception and from 20 to 40 feet for high-frequency reception. The flat-top should be suspended from 30 to 50 feet above the ground. A wire known as the "lead-in" is used as a transmission line from the antenna to the receiver. It is connected near one end of the flat-top and brought down to the primary winding of the receiver antenna coil.

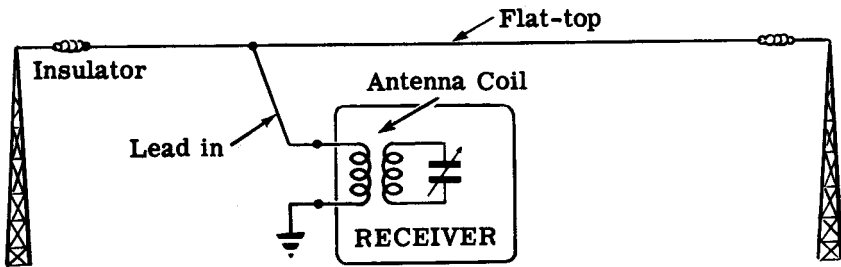

**INVERTED L ANTENNA**

Another common type of antenna is the doublet or dipole antenna. It consists of a horizontal wire divided into two equal sections by an insulator. Each half of the antenna should be a quarter wave long for the frequency band most commonly used. The transmission line from the antenna is connected to the two ends of the primary of the antenna coil.

This type of antenna will give excellent high-frequency response and will also give comparatively noise-free reception on the broadcast band. It may be of interest to note that most television receiver antennas are modifications of the dipole antenna, with metal bars replacing the less rigid wires.

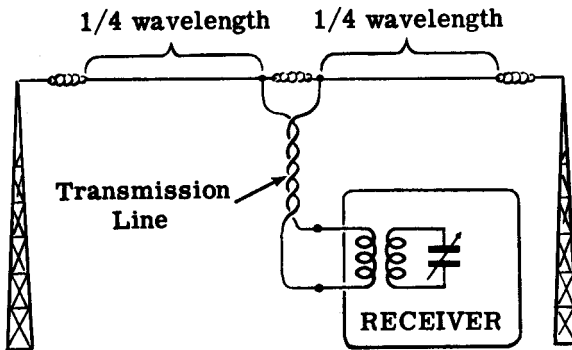

**DIPOLE ANTENNA**

## RECEIVER ANTENNAS

### Types of Receiver Antennas (continued)

Where lack of space makes horizontal antennas impractical, a vertical antenna is used. Vertical antennas, consisting of telescoping metal masts from 3 to 14 feet in length, are commonly used for automobile and portable receivers, and sometimes for home broadcast receivers. An ordinary lead-in wire is run from the bottom of the antenna to the primary of the antenna coil of the receiver. The other end of the primary should be grounded.

VERTICAL ANTENNA

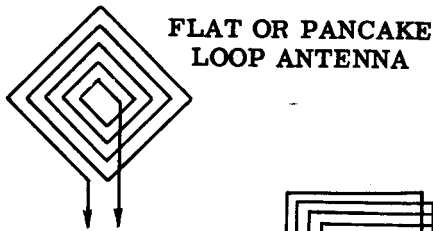
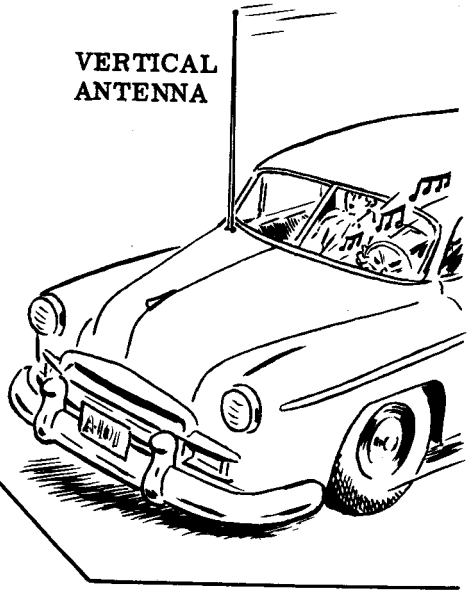

FLAT OR PANCAKE LOOP ANTENNA

BOX LOOP ANTENNA

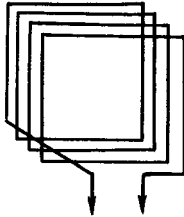

Another type of antenna used for portable and home receivers is the loop antenna. The loop consists of a coil of wire which is connected to the two ends of the primary of the antenna coil. Most home broadcast-band receivers contain a loop antenna within the cabinet.

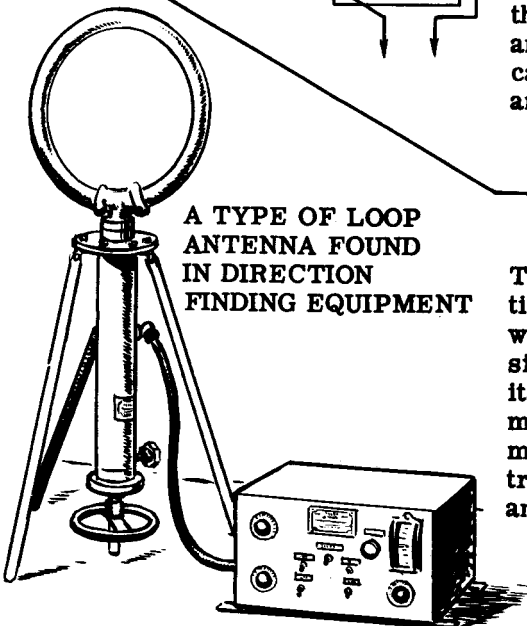

A TYPE OF LOOP ANTENNA FOUND IN DIRECTION FINDING EQUIPMENT

The loop antenna is highly directional. When it is pointed edge-wise toward a transmitter, the signal pickup is maximum; when its flat side is toward the transmitter, the signal pickup is minimum. This property makes it extremely useful for radio-beacon and direction-finding equipment.

## RECEIVER ANTENNAS

### Considerations in Selecting and Installing an Antenna—Noise

An important consideration in antenna installation is that of noise. Noise consists of radio waves of many frequencies and is produced by both man-made and natural electrical disturbances. Among the more important man-made noise producers are elevators, fans, refrigerators, automobile ignition systems, vacuum cleaners, X-ray and diathermy equipment, and power lines.

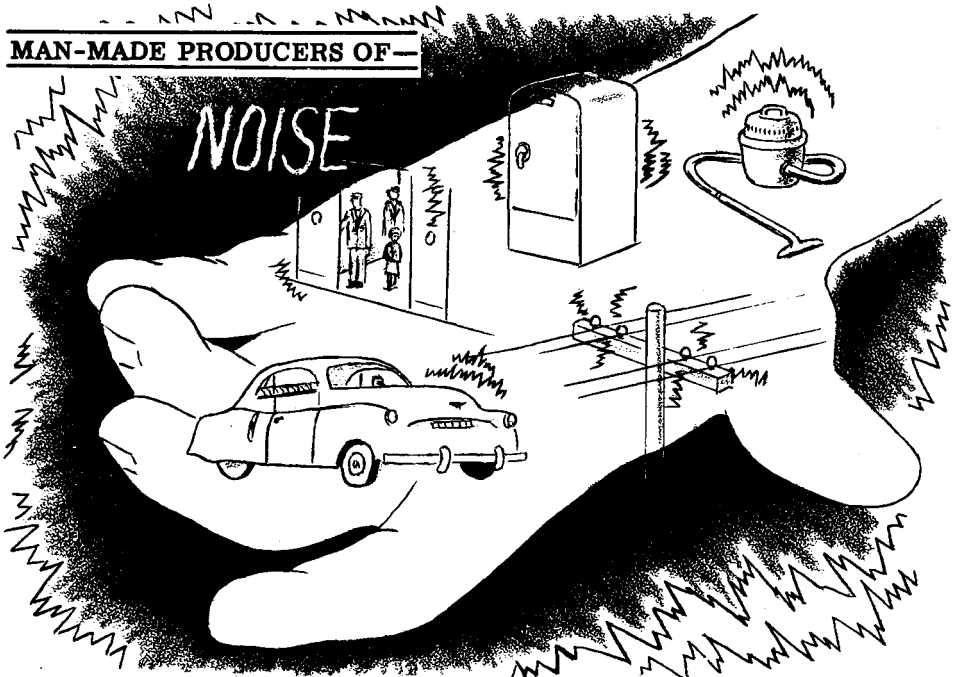

The antenna cannot differentiate between desired signals and undesired radio noise. It is customary to compare the signal pickup of the antenna with the noise pickup. This relationship is known as the "signal-to-noise ratio." A high signal-to-noise ratio is necessary if one desires to obtain relatively noise-free reception.

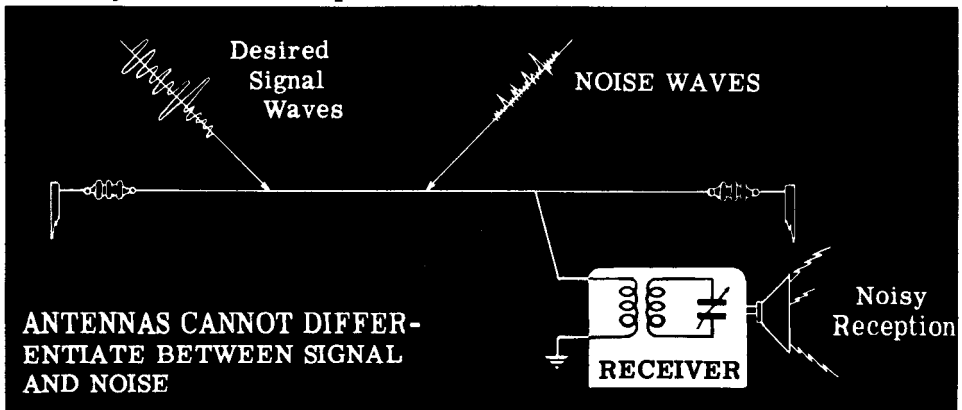

## RECEIVER ANTENNAS

### Considerations in Selecting and Installing an Antenna—Noise (continued)

There are various ways by which a high signal-to-noise ratio may be obtained. The first method is by locating the antenna as far as possible from elevator shafts, street car and power lines and other devices likely to produce noise. Placing the antenna at right angles to the power line will also reduce the amount of noise.

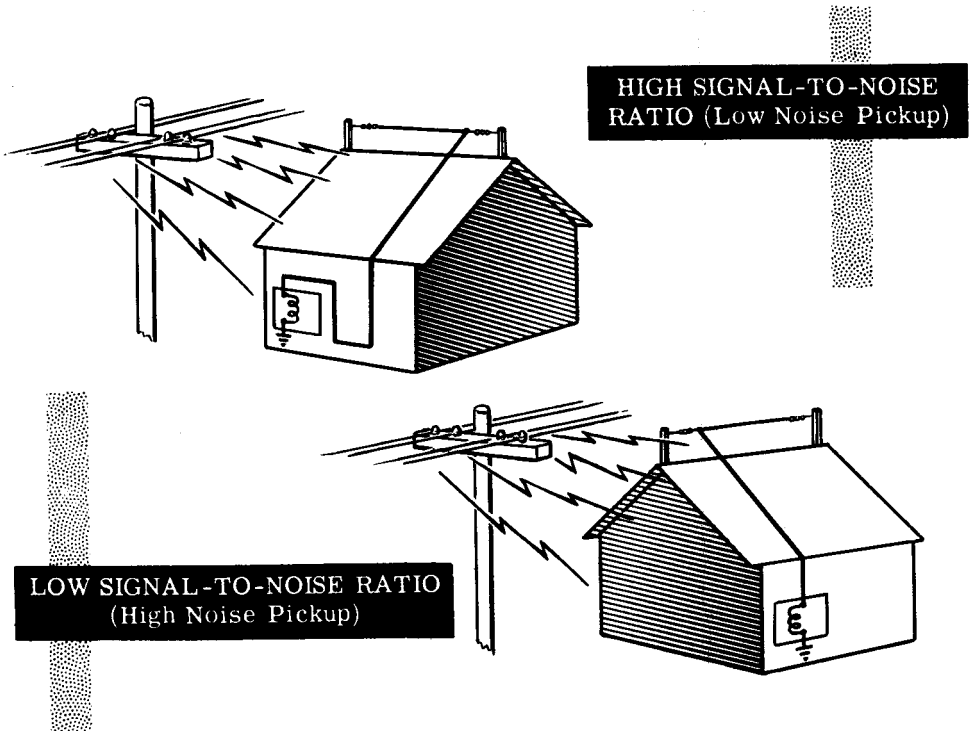

The second method is by increasing the height of the antenna as much as practical considerations will allow. This tends to increase the signal strength and reduce the amount of noise.

The third method involves using a good ground connection to the receiver when provision is made for one. A poor ground lead may pick up noise; therefore, it should be as short as possible and away from noise-producing devices. A good ground lead should use rubber-insulated wire, size No. 14 or larger. It should make good contact through a ground clamp to a grounded object, such as a radiator or water pipe. Gas pipes should never be used for grounding purposes.

A good deal of noise may be picked up by the lead-in. If the lead-in uses two wires, as in the case of the transmission line used with a doublet antenna, noise can be reduced by using twisted wires or by reversing the positions of the wires every few feet. Noise can also be reduced by using shielded lead-in wires.

## RECEIVER ANTENNAS

### Considerations in Selecting and Installing an Antenna—Signal Losses

The second factor to be considered in selecting and installing an antenna is that of signal losses. The antenna should be placed as far as possible from metal objects, chimneys, walls, and tree branches which absorb radio waves and thus reduce the strength of the signal reaching the antenna. A loose or swinging antenna may cause the signal to fade.

#### FACTORS THAT CAUSE ANTENNA SIGNAL LOSSES...

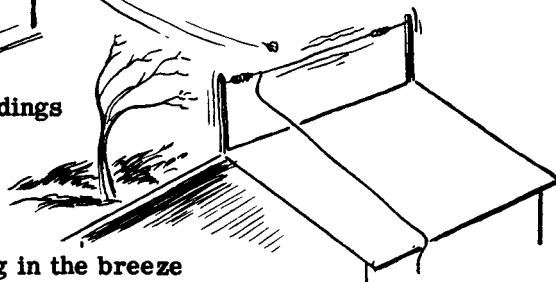
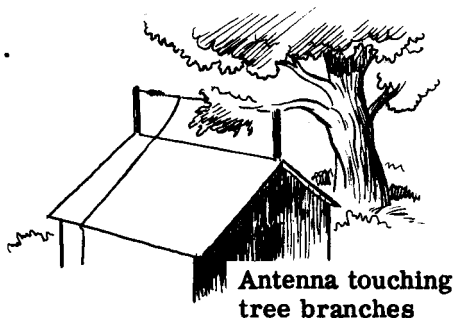
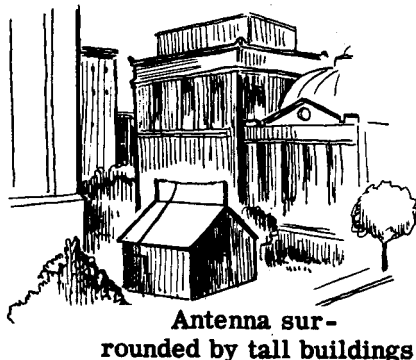

Signal losses will also be increased if a high resistance is present in the antenna circuit. To reduce resistance, all joints and connections should be carefully soldered and, wherever possible, the antenna and lead-in should consist of a single piece of wire with no joints.

Signal losses may be further increased by leakage of current through poor supporting insulators. These insulators should be made of materials such as glazed porcelain or pyrex glass, which do not readily absorb moisture and thus provide a leakage path for current.

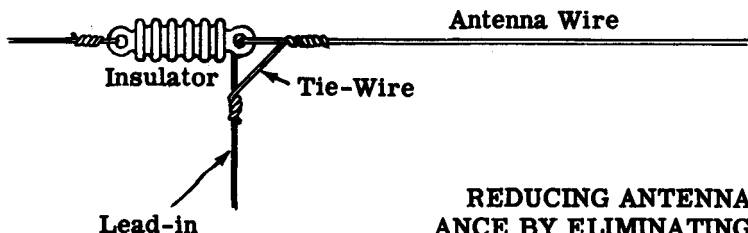

REDUCING ANTENNA RESISTANCE BY ELIMINATING JOINTS

## RECEIVER ANTENNAS

### Considerations in Selecting and Installing an Antenna— Frequency Response and Directivity

The third consideration is that of frequency response which is related to the antenna length. A maximum signal, at a given frequency, will be induced in the antenna if it is one-quarter or one-half the wavelength of the signal to be received. If desired, it is possible to change the effective length of an antenna by placing a coil or capacitor in series with it. Adding inductance increases the electrical length of the antenna, while adding capacity shortens it. The front panel of certain receivers contains a control marked ANT. COMP. (antenna compensation). This control varies the size of a small capacitor and is used to compensate for variations in antenna length. In general, adjustment of the antenna to the correct length is not nearly as important or critical for receiving equipment as for transmitters.

The final consideration is that of directivity. All antennas, except the vertical type consisting of a single perpendicular wire, have a directional effect and receive signals from certain directions better than from others.

A horizontal or inverted L antenna will receive best when the signal cuts the antenna wire at right angles. For any one station the antenna may be turned so that it produces the maximum signal pickup. However, since it is extremely unlikely that all transmitters will be broadcasting from the same direction, the placement of the antenna will probably be a compromise for all stations.

The directional effects of the loop antenna have already been discussed and need not be repeated. Dipole antennas may be made highly directional by arranging them into systems called "arrays," similar to those employed with television systems.

### FACTORS TO BE CONSIDERED IN SELECTING AND INSTALLING ANTENNAS. . .

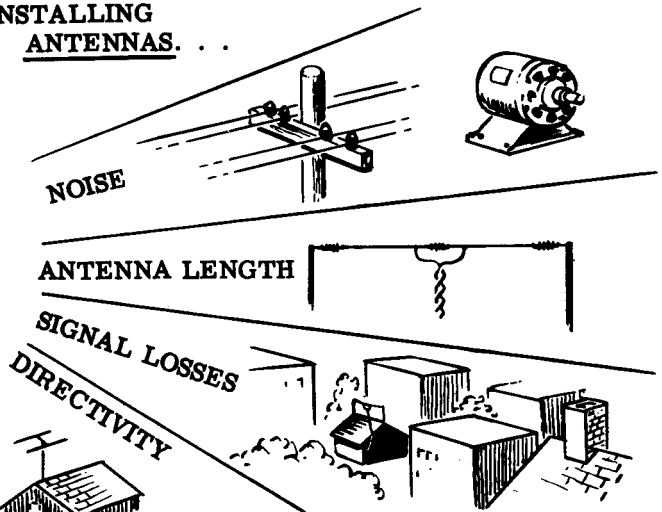



# RECEIVER ANTENNAS

## Review of Receiver Antennas

**ANTENNA FUNCTION**—The receiver antenna picks up signals radiated by a transmitter, and transmits these signals—via the lead-in or transmission line—to the primary of the receiver antenna coil. The electromagnetic waves cutting the antenna induce voltages, thus causing currents to flow which are amplified by the receiver.

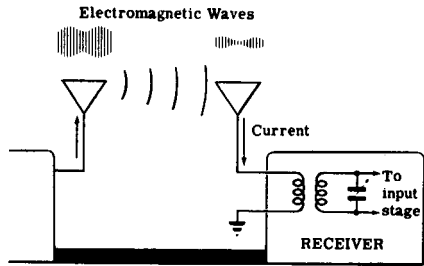

**INVERTED L ANTENNA**—This is one of the simplest and most commonly used types of antennas, consisting of a horizontally supported wire, with the lead-in attached near one end.

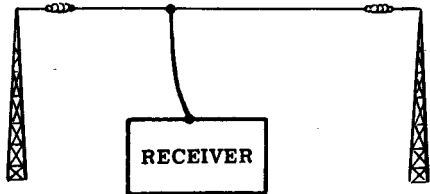

**DIPOLE ANTENNA**—This type of antenna is the same as is used in transmitters, and consists of two quarter wavelength sections supported horizontally. It gives excellent high-frequency response.

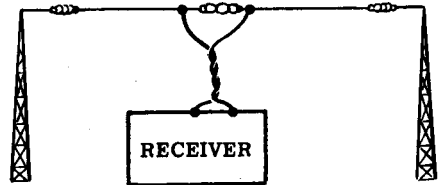

**LOOP ANTENNA**—The loop antenna is used with many portable and home broadcast-band receivers. Because it is highly directional, it is also used in direction-finding equipment.

FLAT OR PANCAKE LOOP ANTENNA



BOX LOOP ANTENNA

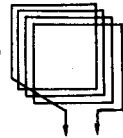

**SELECTION AND INSTALLATION**—Noise, signal loss, frequency response and directivity are the four factors which must be considered when selecting and installing an antenna.

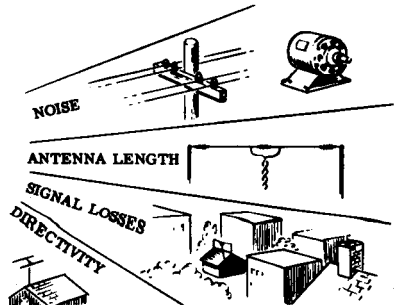

# TRF RECEIVERS—RF AMPLIFIER STAGE

## The TRF Receiver

The TRF receiver is the type of receiver you will study first. You will recall from "Introduction to Receivers" that the TRF consists of an RF amplifier, a detector and an audio amplifier.

So that you may have in mind the goal toward which you are working, shown below are the circuit diagrams of the two TRF receivers you will learn about.

### TRF RECEIVER WITH A REGENERATIVE DETECTOR

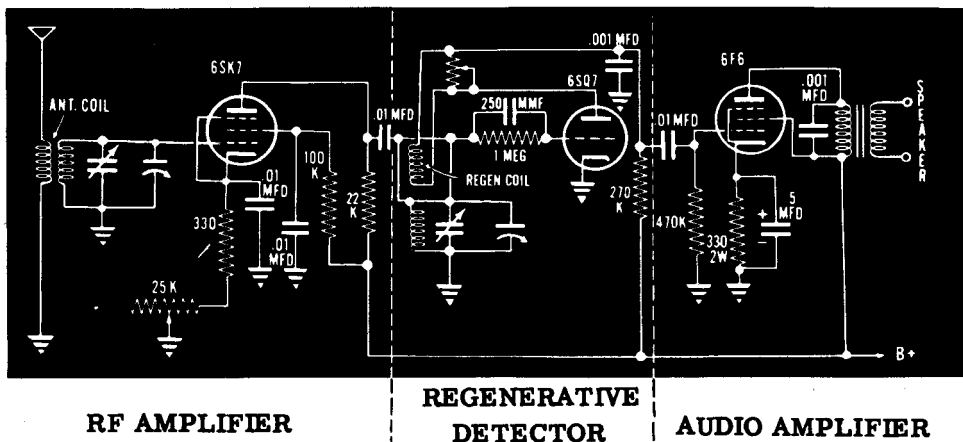

### TRF RECEIVER WITH A PLATE DETECTOR

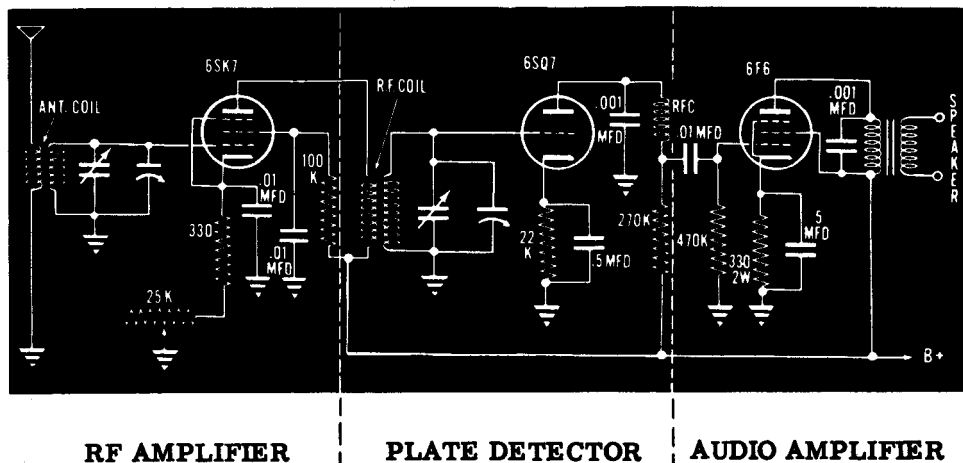

## TRF RECEIVERS—RF AMPLIFIER STAGE

### The RF Amplifier Stage

Every TRF receiver contains one or more stages of RF amplification preceding the detector. The main purpose of these amplifiers is to provide additional selectivity and sensitivity. You will recall that selectivity indicates how well a receiver receives a desired signal and rejects unwanted signals, and that sensitivity is a measure of the receiver's ability to pick up a weak signal. In general, the more RF amplifier stages used, the greater will be the selectivity and sensitivity. On this and the following few sheets you will review some of the outstanding points about RF amplifiers.

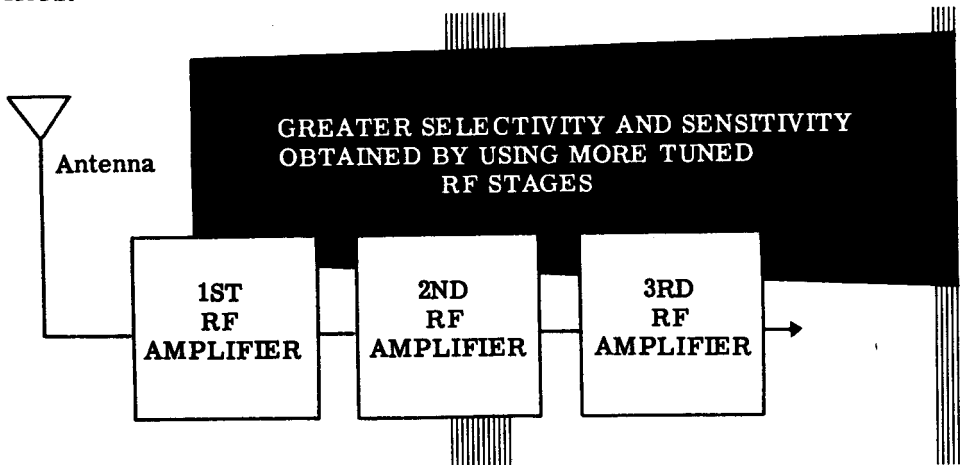

Since the RF amplifier stage is designed primarily for voltage amplification, any tube suitable for voltage amplification may be used. However, triodes are not considered satisfactory because they have a strong tendency to produce undesirable oscillations when employed in RF amplifier stages. Unless the triodes are carefully neutralized to prevent feedback, the oscillations produced are likely to cause considerable trouble.

Tubes containing a screen grid do not suffer from this disadvantage and as a result, most RF amplifiers found in receivers employ either tetrodes or pentodes. The tube which is generally preferred as an RF amplifier is a variable- $\mu$  pentode. The use of this type of tube not only provides for considerable voltage gain, but also minimizes certain types of interference from powerful undesired signals. Since varying the grid bias of a variable- $\mu$  pentode changes the amount of amplification, this type of tube lends itself admirably to applications in circuits involving manual volume control or automatic volume control.

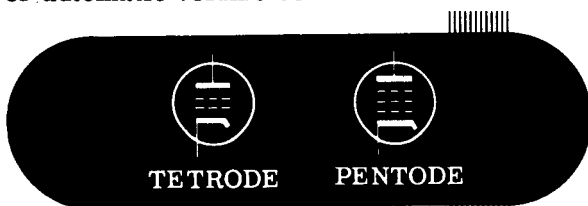

Only screen grid tubes are used in receiver RF amplifiers

## TRF RECEIVERS—RF AMPLIFIER STAGE

### RF Transformers

In the schematic of an RF amplifier stage shown below, you will note that the RF amplifier has two RF transformers. The first, the antenna coil, is designed to couple the antenna circuit to the grid circuit of the amplifier. The second, often referred to as the RF coil, couples the plate circuit of the RF amplifier with the grid circuit of the next stage.

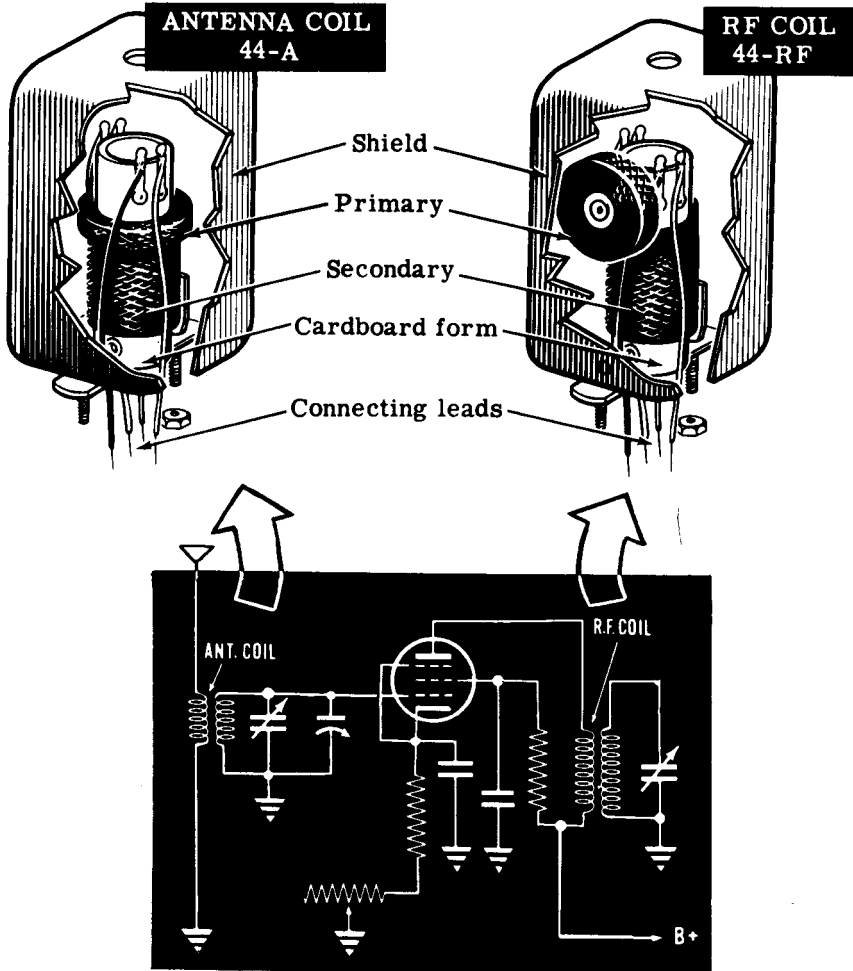

The coils are usually wound on a form made of cardboard or bakelite. They are generally of the air core type, although occasionally, when the frequency of operation is not too high, powdered iron cores may be employed.

RF Transformers (continued)

RF transformers used for broadcast band reception have relatively large primary windings which tend to resonate at low frequencies and produce greater gain at the low end of the dial. To compensate for this, capacitive coupling between primary and secondary is used to increase the gain at the high frequency end of the dial. This is accomplished during the manufacture of the coil, by connecting a small capacitor of from 3 to 10 mmfd capacity between the primary and secondary windings, or by using a loop of wire, known as a "gimmick" or "capacity turn." This wire is connected to the primary and is wrapped around, but insulated from, the secondary.

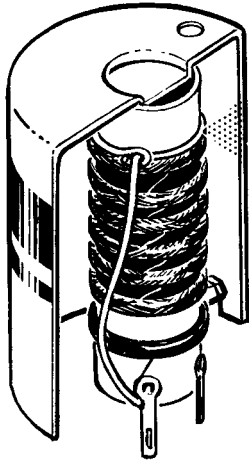

the  
Gimmick

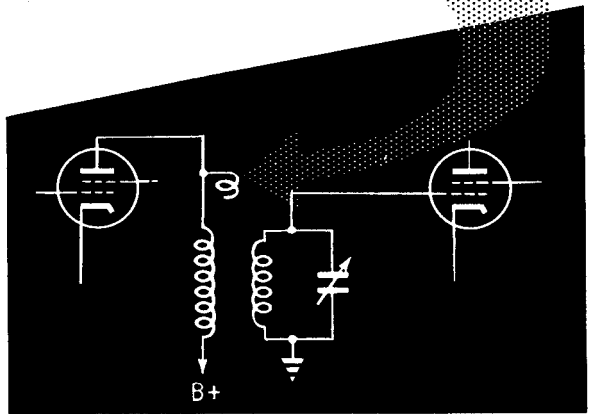

Perhaps you will recall some references, made in "RF Amplifiers," to the "Q" of a resonant circuit. This Q, which is equal numerically to the reactance of the coil divided by its resistance, determines both the selectivity and voltage gain that can be obtained from a resonant circuit. In order to keep the selectivity high, it is therefore necessary to use RF transformers whose resistance is fairly low.

Another important consideration is that of shielding. Unless RF transformers are shielded by means of copper or aluminum shields grounded to the chassis of the receiver, there probably will be undesirable coupling and the production of unwanted oscillations. It should also be noted that shielding changes the inductance and Q of a coil. Consequently any receiver adjustments, such as the alignment process which will be described shortly, should be performed with the shields in place.

## TRF RECEIVERS—RF AMPLIFIER STAGE

### Band Switching

You will note that while the primaries of these transformers are untuned, variable capacitors are connected across the secondary coils, thus forming resonant or tuned circuits. These resonant circuits are responsible for the high selectivity and sensitivity of the TRF receiver.

If a receiver is to cover a frequency range greater than one coil and one tuning capacitor will allow, it will be necessary to change the tuning circuits. This is usually accomplished by substituting a different coil. One system uses removable plug-in coils, while another system uses several mounted coils whose leads run to a multicontact rotary switch, known as a "selector" or "band switch." By turning the switch, any coil may be connected to the tuning capacitor and thus provide a satisfactory response for any desired band of frequencies.

A good example of a receiver employing band switching is shown below. In this receiver the selection of the frequency band is accomplished by rotating a four-position switch. Each switch section can connect any one of four RF coils to a variable capacitor.

### BAND SWITCHING

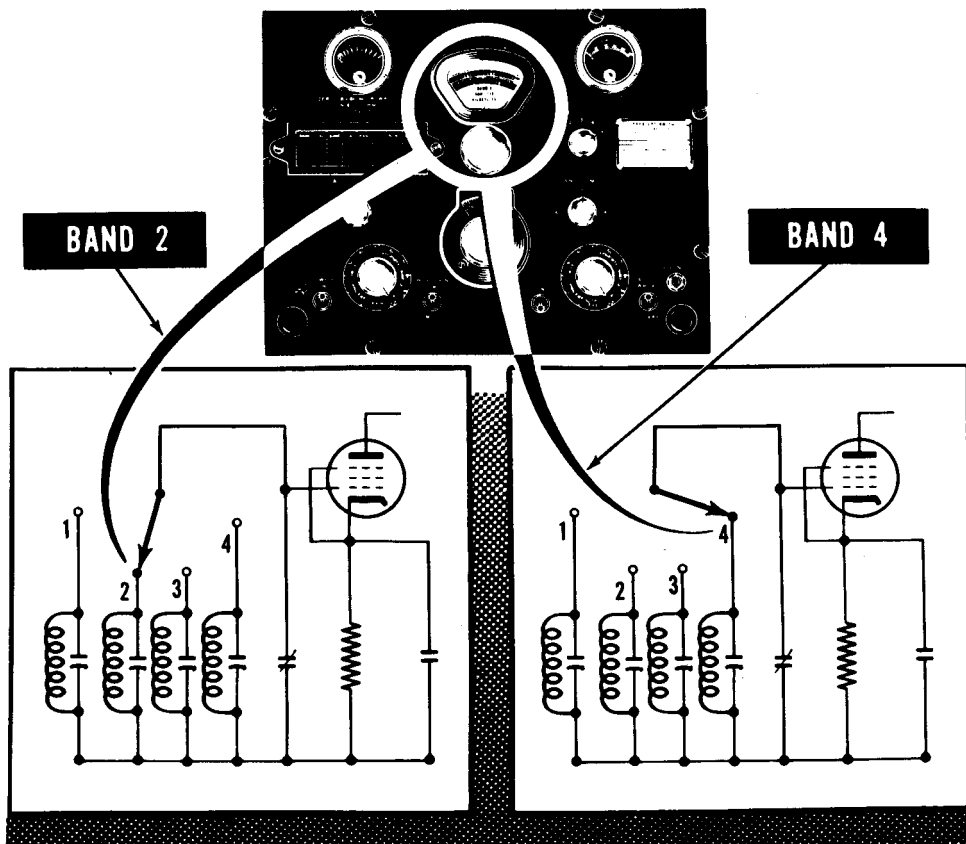

## TRF RECEIVERS—RF AMPLIFIER STAGE

### Ganged Capacitors and Alignment

Every TRF receiver has a minimum of two tuned circuits, one associated with the RF amplifier and one with the detector. In the early days of the TRF, each variable capacitor in the tuned circuit was connected to its own individual tuning knob. In order to tune your radio to a station, you had to turn each knob individually until each tuned circuit was resonant to the frequency of the desired station.

The modern TRF receiver eliminates the need for individual tuning knobs by having the variable capacitors of all the tuned circuits mounted on one shaft. This allows the receiver to be tuned with a single control which varies all the tuned circuits together and at the same time. This is called "ganged" tuning. In a receiver having two RF amplifier stages plus a detector, a three-gang capacitor would be used.

Since all of the tuned circuits are varied together, all of the variable capacitors should have exactly the same capacity, at the same time, for various settings. All of the tuned circuits would then be resonant to the same frequency at the same time—resulting in maximum sensitivity and selectivity.

Unfortunately, no two capacitors can be manufactured exactly alike, and therefore the individual capacitor sections on a ganged unit will have slightly different capacities at every setting. If nothing were done to compensate for these differences in capacity, the tuned circuits in a receiver would be resonant to slightly different frequencies for every setting of the tuning knob—causing poor receiver selectivity and sensitivity. Such a receiver is said to be "out of alignment."

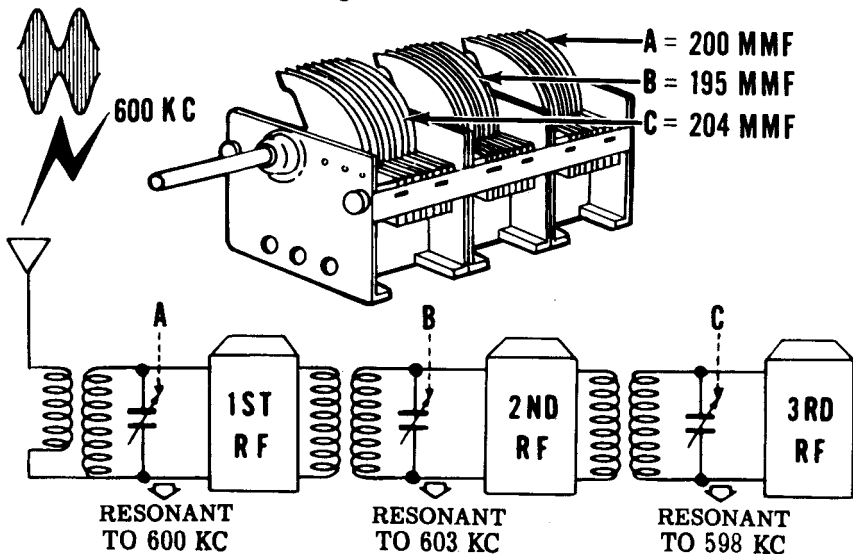

**RECEIVER OUT OF ALIGNMENT**

## TRF RECEIVERS—RF AMPLIFIER STAGE

### Trimmer Capacitors and Coils

The problem of misalignment can be solved by adding small variable capacitors, called "trimmer capacitors," in parallel with the main variable tuning capacitors.

Sometimes the adjustment is made in the coil of a tuned circuit rather than on the capacitors. In this case, an iron-cored slug is moved in and out of the coil, causing the inductance to vary. This is called "slug tuning."

In receivers covering only one band, the trimmers are usually located on the ganged capacitors, one for each section. In receivers using band switching, the trimmers for each range are usually mounted on, and in parallel with, the individual coils. These trimmer capacitors are adjusted after the main capacitors have been set at minimum capacity at the high end of the dial. They are adjusted to make the total capacity of the individual tuned circuits the same at every setting of the tuning control. The tuned circuits will, therefore, be tuned to the same frequency, simultaneously, all over the band—resulting in high receiver sensitivity and selectivity.

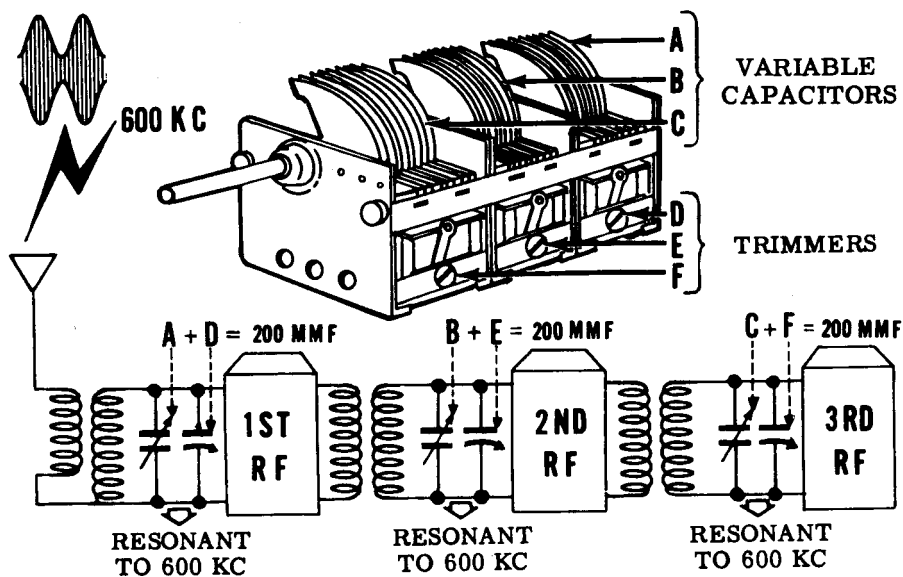

### RECEIVER IN ALIGNMENT

It sometimes happens that although the circuits are properly adjusted at the high end of the dial, they may not tune to identical frequencies at the other end of the dial. A correction may be made for this, in some sets, if the end rotor plates are of the slotted type. Adjustments can be made by bending a portion of the slotted plates toward, or away from, the stator plates. When all of the stages tune to identical frequencies at all dial settings, they are said to be "tracking" and the receiver is in alignment.



## TRF RECEIVERS—RF AMPLIFIER STAGE

### Grid Bias Manual Volume Control

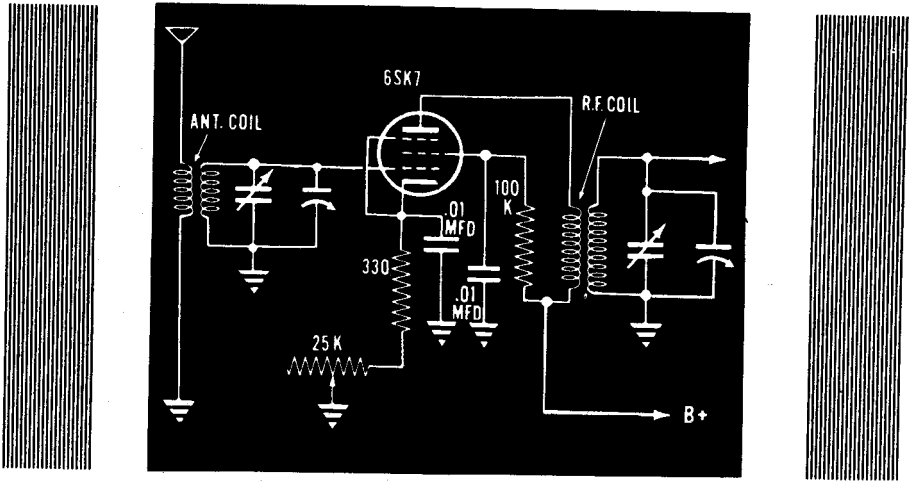

Since signals arriving from different transmitters will vary in intensity, it is necessary to provide a volume control so that the gain of the RF amplifier and the loudness of the signal can be varied. One of the most common methods of controlling the gain of a TRF is to change the bias voltage of the RF amplifier stage by placing a variable resistor in the cathode circuit.

You will recall, from previous discussion, that the RF amplifier stage usually employs a variable-mu pentode tube. Varying the bias of this variable-mu tube causes the amplification factor of the tube to vary, and therefore the gain of the stage to vary. If there are several RF amplifiers, the variable resistor may be connected in such a manner as to vary the bias of all of the RF amplifiers. The fixed resistor in the cathode circuit is placed there to provide the proper bias when the variable resistor is set for maximum gain at the zero resistance position.

A variation of the grid bias volume control employs a potentiometer, which also acts as a variable shunt across the primary of the antenna coil. When the moving arm of the potentiometer is moved to the left, the resistance across the primary of the antenna coil is reduced while the cathode resistance is increased. This results in a weaker signal on the grid and reduced voltage amplification. When the sliding arm is moved to the extreme right, the resistance across the primary is increased, while the cathode resistance is reduced. This produces a stronger signal on the grid and increased voltage amplification.

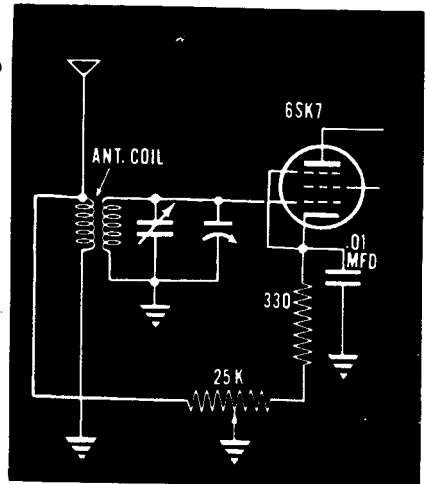

## Analysis of the RF Amplifier

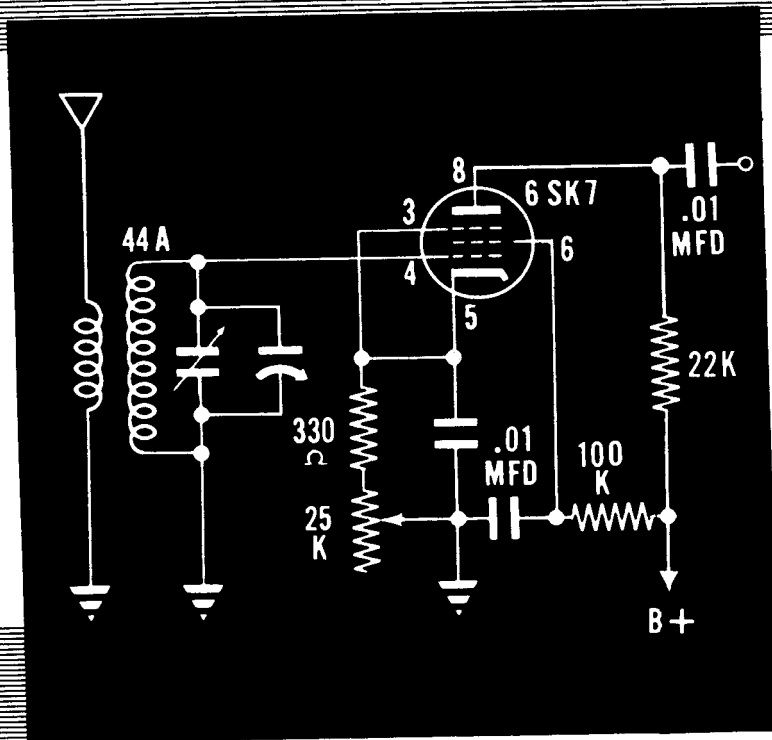

## The RF Amplifier

Suppose you pause for a moment to examine the RF amplifier shown above and to review the purpose of each component. The antenna coil couples the antenna to the control grid of the RF amplifier. The variable capacitor enables the operator to tune the amplifier to the frequency of the desired signal, and thus provides selectivity. The 25K variable resistor acts as a volume control, while the 330-ohm resistor provides limiting cathode bias. The .01 mfd capacitor between the cathode and ground is the cathode bypass capacitor. The 100K resistor in the screen grid circuit is the screen grid voltage dropping resistor, which serves to keep the screen grid at a lower positive potential than the plate. The .01 mfd capacitor in the screen grid circuit is the screen grid bypass capacitor, which acts as a bypass for RF signals, and enables the screen to act as a shield between the plate and the control grid. The 22K resistor in the plate circuit is the plate load, while the .01 mfd capacitor in the plate circuit is used for the purpose of coupling the plate circuit to the grid of the next stage, and at the same time effectively blocking the passage of direct current.

## TRF RECEIVERS—AUDIO AMPLIFIER STAGE

### What the Audio Power Amplifier Does

Your next job with radio receivers will be to review an audio power amplifier. You need an audio power amplifier in your receiver because you will want to pick up stations and hear them in a loudspeaker. Loudspeakers have to push the air and make it move in order to produce sounds.

A loudspeaker converts electrical power into sound power. To supply the loudspeaker with sufficient power, an audio power amplifier is put in as the last stage of a receiver.

Like the RF amplifier, you will find an audio power amplifier in just about every receiver you will repair or operate. Here is a chance to add another building block to your know-how on receivers.

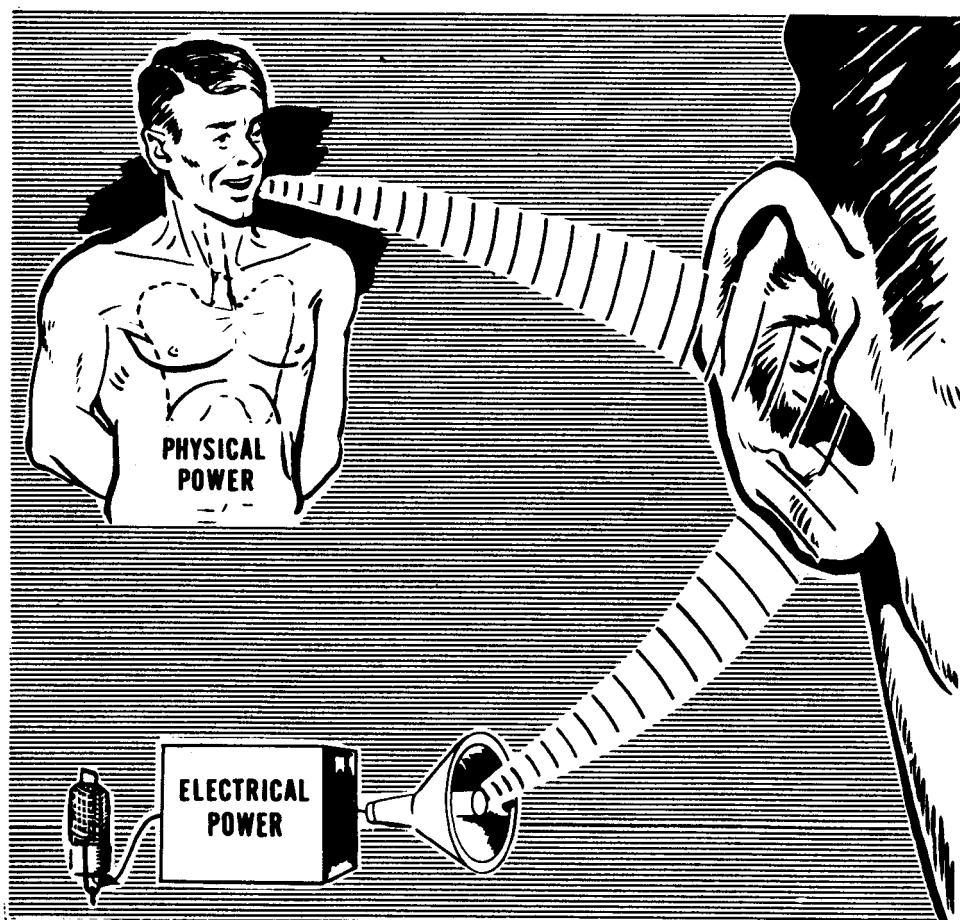

## TRF RECEIVERS—AUDIO AMPLIFIER STAGE

### AF Amplifier Tone Control Circuits

The tone or pitch of a complex sound depends upon whether there is a greater proportion of high frequency or low frequency waves in the sound. In other words, a high-pitched sound has more high frequency sound waves, while a low-pitched sound consists mainly of low frequency sound waves.

The sound emitted by a radio receiver may differ considerably from the original sound applied to the transmitter. The main reason for this is that audio amplifiers do not amplify all the frequencies by the same amount, and loudspeakers do not respond equally well to all frequencies.

Other causes of distortion are static and tube noises which generally are high audio frequencies of a random nature. To prevent the annoying interference from static and noise, and to provide a deeper bass effect which most radio listeners seem to prefer, many radio receivers employ some means of tone control. This is accomplished by eliminating some of the higher frequencies—shunting them to ground or bypassing them around the output transformer.

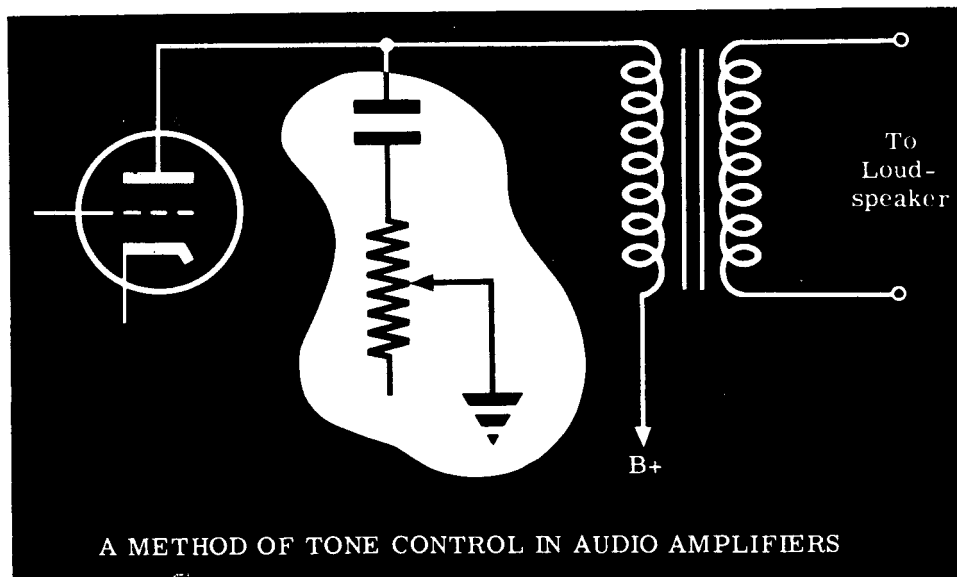

You will note that the capacitor in the plate circuit offers a relatively easy path for the higher audio frequencies, while the lower audio frequencies encounter a path of less opposition by traveling through the primary coil of the transformer. In this way, the amount of high frequency sound reaching the loudspeaker is considerably reduced. The variable resistor acts as a means of tone control. If the resistance is made very high, the path through the capacitor to ground becomes one which offers high opposition to the passage of high frequency as well as low frequency signals. As a result less high frequency current flows through the bypass capacitor and there is a rise in the pitch of the sound coming out of the loudspeaker.

## TRF RECEIVERS—AUDIO AMPLIFIER STAGE

### AF Amplifier Volume Control

You have previously been given a description of one method of controlling the volume of a receiver. This method involved varying the bias of the RF amplifier stage. There is another commonly used method of volume control involving the detector and AF amplifier stages.

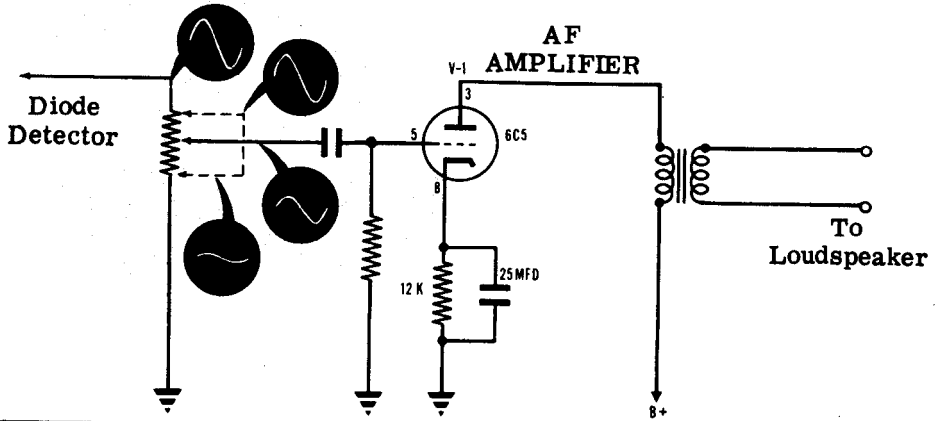

### DETECTOR-OUTPUT VOLUME CONTROL

Notice that the detector is coupled to the AF amplifier by means of resistance-capacity coupling circuit. The volume control is basically a voltage divider, the moving arm tapping off the desired amount of signal voltage which is then applied, through the coupling capacitor, to the grid of the AF amplifier. This type of volume control is frequently employed in superhet receivers.

Some receivers employ a dual type of volume control. This control regulates the gain in the first and second RF amplifier stages by varying the cathode bias, and also controls the gain by varying the amplitude of the input signal applied to the first AF amplifier.

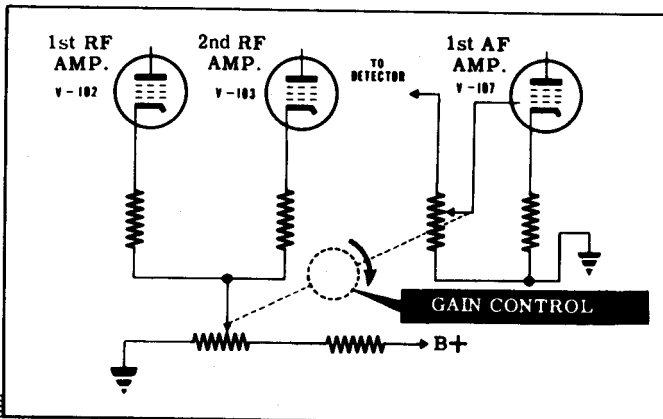

### GRID CONTROL OF RECEIVER

## TRF RECEIVERS—AUDIO AMPLIFIER STAGE

### Analysis of the AF Amplifier Circuit

Now stop for a few minutes and analyze the functions of the various component parts of the AF power amplifier circuit shown here. Notice that no provision is made in this AF amplifier stage for volume or tone control.

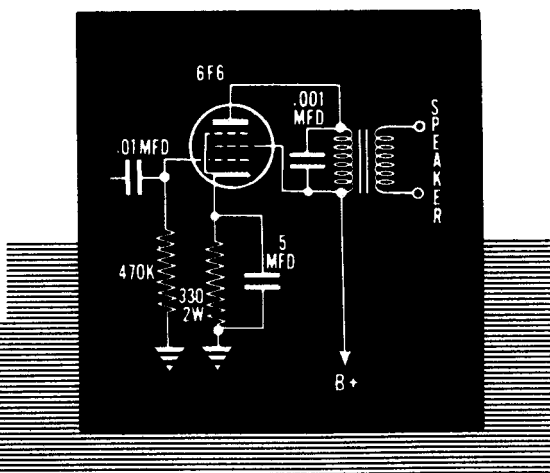

The 0.01-mfd coupling capacitor and 470K grid resistor found in the control grid circuit couple the control grid of the amplifier to the preceding detector stage. The capacitor also reduces the possibility that any DC voltages from the detector stage might be impressed upon the control grid of the amplifier.

The 330-ohm resistor acts as a cathode bias resistor, while the 5-mfd capacitor bypasses the varying component of the plate current around the cathode resistor, thus preventing the production of a varying bias and the accompanying reduction in amplification.

The primary of the output transformer acts as the plate load and couples the amplifier to the loudspeaker. The .001-mfd capacitor across the primary bypasses high frequency audio signals around the primary and this reduces the amount of high frequency sounds and noises emitted by the loudspeaker.

Components	Functions
0.01-mfd capacitor and 470K resistor	Couples AF amplifier to preceding detector stage
330-ohm resistor	Provides cathode bias
5-mfd capacitor	Bypasses signal around cathode bias resistor
0.001-mfd capacitor	Prevents high frequency audio signals from entering loudspeaker
Output transformer	Acts as plate load and couples amplifier to loudspeaker

## TRF RECEIVERS—AUDIO AMPLIFIER STAGE

### Comparison of RF and AF Amplifiers

Since most radio receivers you will encounter contain both RF and AF amplifiers, you must possess a clear understanding of the differences between them and the advantages and disadvantages of each. The following comparisons should serve to clarify your conceptions of RF and AF amplifiers.

#### RF Amplifiers

1. Designed to amplify frequencies above 20,000 cycles.
2. Usually have tuned circuits, thereby adding selectivity.
3. Usually coupled to other stages by RF air-core transformers.
4. Precede the detector stage.
5. Designed for voltage amplification.
6. If triodes are used they lack stability and must be neutralized.
7. Generally employ variable- $\mu$  pentodes.

#### AF Amplifiers

1. Designed to amplify frequencies between 15 cycles and 20,000 cycles.
2. Untuned and do not add to selectivity of set.
3. Coupled to other stages by AF iron-core transformers, or by resistance-capacity coupling.
4. Follow the detector stage.
5. Designed for power amplification.
6. Very stable and not likely to oscillate—if triodes are used, no neutralization is required.
7. Generally employ triodes, beam-power tetrodes, and power pentodes.

**TYPICAL RF AMPLIFIER STAGE**

**TYPICAL AF AMPLIFIER STAGE**

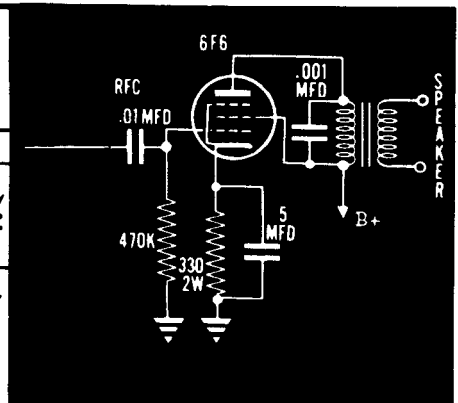
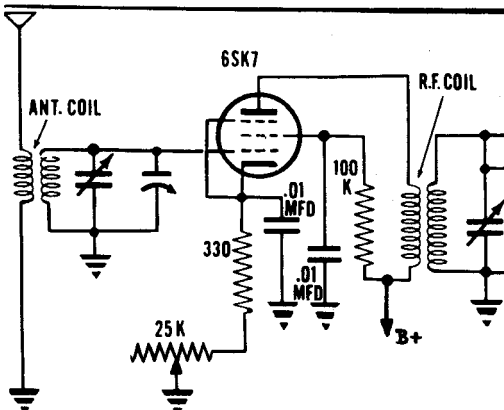

What the Detector Does

The detector is the key circuit of the radio receiver. The primary purpose of this circuit is to change the RF signal into a signal which can be reproduced as sound by the headphones or loudspeaker. Without the detector, radio reception is not possible. The simplest radio receiver contains a detector, an antenna and a pair of headphones. All of the other stages which are found in more complex receivers, such as the TRF and superhet, have been placed there for the primary purpose of enabling the detector to do a better job. In order to understand the purpose of the detector, it is necessary to review briefly the theory of radio-telephone transmission.

In the section on radio transmitters, it was made clear that radio-telephone transmission requires the generation of a radio-frequency carrier wave. Intelligence is impressed upon this wave by varying the amplitude of the carrier wave in direct proportion to the amplitude of the sound impulses. This combination of audio-frequency waves superimposed upon a carrier wave is known as an amplitude-modulated signal. It is this combination of waves that is picked up by the antenna of the radio receiver.

When transmitted signals reach a receiver, the desired signal is selected by the tuned circuit of the detector, or of the RF amplifier stage if the receiver employs such a stage. The selected signal is then rectified by a crystal or vacuum tube rectifier in the detector. The RF component is filtered out of the rectified signal, and the audio component is changed into sound waves by earphones or a loudspeaker. The process of detection includes the rectification and filtering steps, and these two steps are performed by the detector.

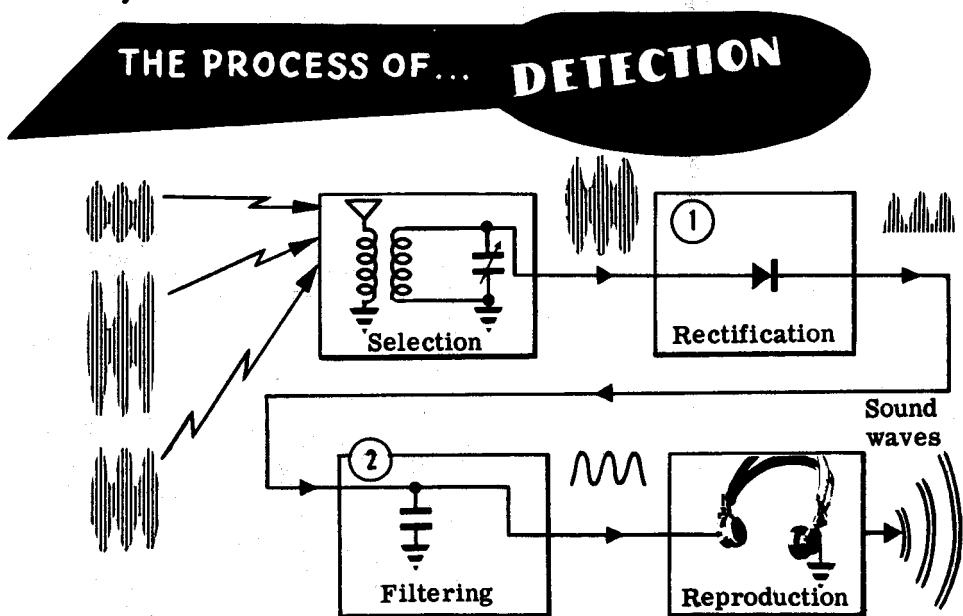



The Crystal Detector

The simplest of all detectors is the crystal type. If you understand how it works, you should have very little trouble understanding the operation of the somewhat more complicated vacuum-tube detectors.

**A CRYSTAL DETECTOR**

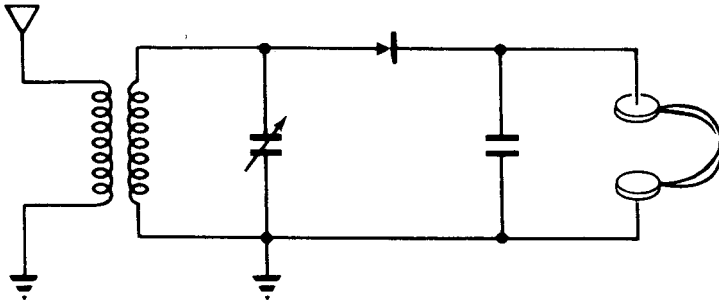

The modulated radio waves which are radiated from the transmitter's antenna induce corresponding signal voltages and currents in the antenna-ground system of the radio receiver. These signals are then transferred to the detector circuit by means of a radio-frequency transformer. If there are several transmitters in operation nearby, there will be several signals found at this point. Unless these signals are separated from each other, they will all be detected and the listener will hear a confused mixture of sounds. In other words, the selectivity will be extremely poor. It is the function of the coil and variable capacitor to separate these signals and thus provide selectivity. The coil and capacitor are called the "tuned circuits."

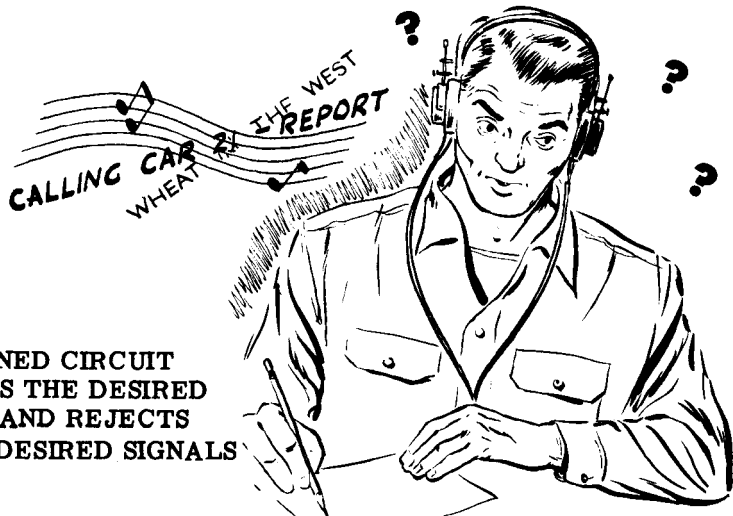

# TRF RECEIVERS—REGENERATIVE DETECTOR

## How the Crystal Detector Works

You will probably recall from a previous discussion dealing with the selectivity of RF amplifiers that signals of differing frequencies can be separated from each other by taking advantage of the selective properties of a resonant or tuned circuit. A circuit of this type generally contains a fixed coil and a variable capacitor. It is capable of selecting or accepting radio signals of one particular frequency and rejecting those of all other frequencies. In addition, the tuned circuit produces a step-up or gain in signal voltage at resonance.

The tuned circuit can be adjusted to resonate or respond to a higher or lower frequency signal by varying the size of the capacitor. You will also encounter tuned circuits in which the capacity is kept constant and the tuning is accomplished by varying the inductance of the coil. Nevertheless, most resonant circuits are tuned by varying the capacitor.

Returning to our crystal detector, it is apparent that the variable capacitor and the secondary of the RF transformer form a tuned circuit. It is this circuit that gives the detector some degree of selectivity or ability to discriminate between desired and undesired signals.

The selected signal is rectified by the detector and the result is a pulsating DC signal containing two components, one of which is radio frequency and the other, audio frequency. The AF component passes through the headphones and produces sound waves similar to those originally used to modulate the radio wave. The RF component is bypassed around the headphones by the filtering action of a small capacitor placed across the headphones.

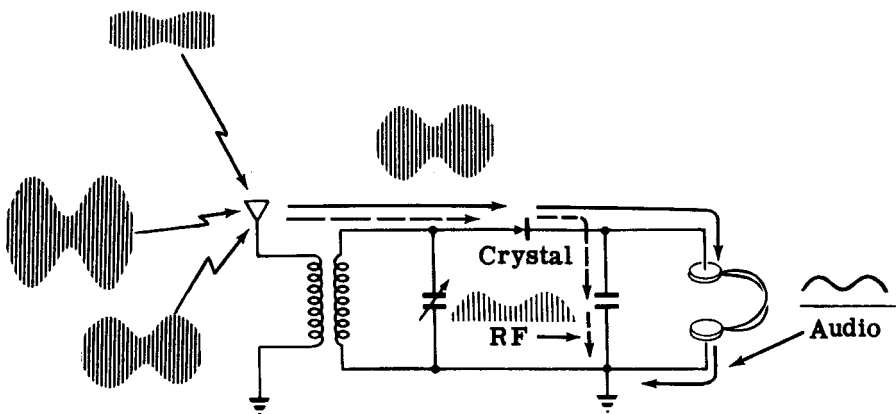

**HOW A CRYSTAL DETECTOR WORKS**

—————> Audio Frequencies  
- - - - -> Radio Frequencies

## TRF RECEIVERS—REGENERATIVE DETECTOR

### Characteristics of the Crystal Detector

The crystal detector possesses the advantages of simplicity and economy. In addition, it requires no batteries or other local sources of power. There are no filaments to burn out or produce hum and noise. In applications requiring the detection of ultra-high frequency signals, the crystal possesses certain decided advantages over the vacuum-tube detector.

Although transistors, which are crystals capable of amplifying signals, have been developed recently, the ordinary crystal detector provides no amplification. The crystal detector is therefore characterized by low sensitivity.

The galena crystal has still another disadvantage. Certain portions of the face of the crystal have better rectifying properties than the remaining portions. This makes it necessary to explore the face of the crystal with a wire probe called a "cat's whisker" until a sensitive rectifying point is found. The wire can easily be dislodged from this sensitive point and consequently, reception is likely to be erratic. In addition, dirt, grease or air-borne dust may spoil the sensitive spot and make it necessary to search for another spot.

These difficulties have been overcome in the more modern germanium and silicon crystal rectifiers. These consist of small sealed cartridges containing contact wires that cannot be dislodged. They have an extremely long life and resist shock and vibration better than most conventional vacuum tubes.

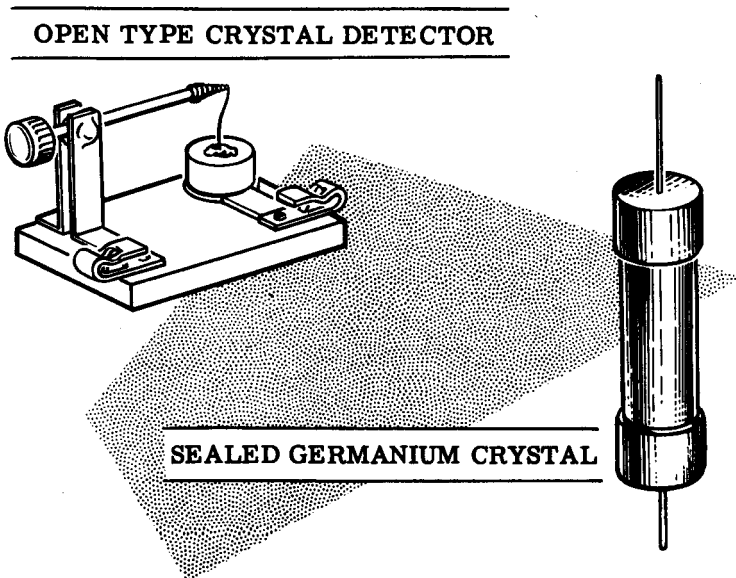

## TRF RECEIVERS—REGENERATIVE DETECTOR

### The Diode Detector

The fundamental circuit of the diode detector closely resembles that of the crystal detector. Consequently, the operating principles and characteristics of these two detectors resemble each other closely.

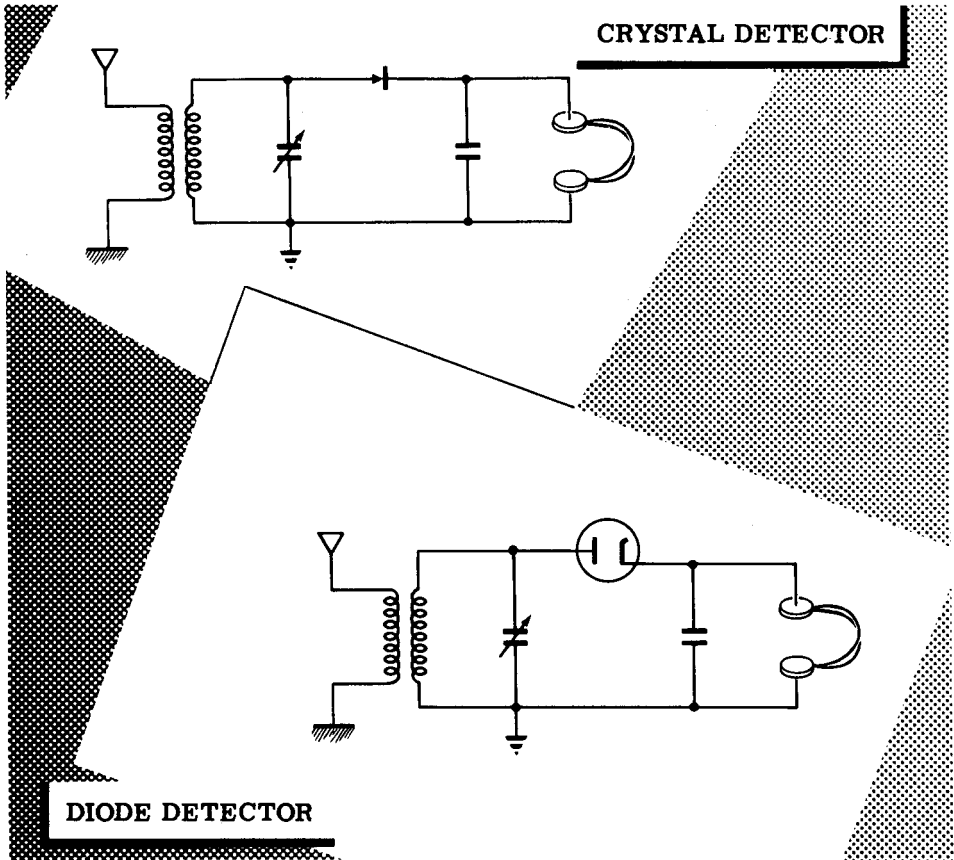

You will observe that the only difference between the diode and crystal detectors is the replacement of the galena crystal by a diode tube. The processes of selection, rectification and filtering are carried on in the manner previously described under crystal detectors. Diode detectors are characterized by faithful reproduction and low sensitivity. When the detector is operating, plate current flows through the tuned circuit during the positive half of each signal cycle. This plate current flow produces what is known as a "loading effect." This in turn has the effect of reducing both the voltage gain and selectivity of the tuned circuit.

Because of these factors and because it is capable of handling large signal voltages without distortion, the diode detector is generally preceded by one or more tuned RF amplifiers which provide increased sensitivity and selectivity. The detector is usually followed by one or more stages of AF amplification to provide sufficient power to operate a loudspeaker.

## TRF RECEIVERS—REGENERATIVE DETECTOR

### The Grid-Leak Detector

You have seen that since the diode detector cannot amplify, it is generally used in a receiver containing several stages of amplification. If you desire a receiver which uses fewer tubes, it is necessary to use a more sensitive detector—one which amplifies as well as detects. In order to amplify, the detector must of necessity use a tube containing a control grid, such as a triode, tetrode or pentode.

The triode detector which is easiest to understand is the grid-leak detector. This is because the grid-leak detector is basically a diode detector followed by a stage of audio-frequency amplification.

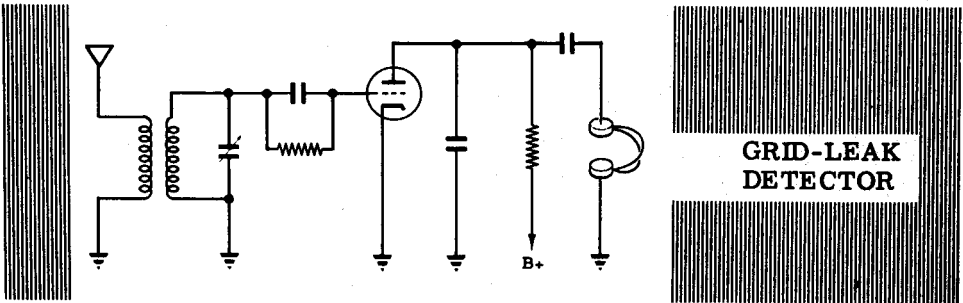

Suppose you examine the grid and cathode circuits of this detector and temporarily forget about the plate circuit. The result will be the circuit shown in the following diagram:

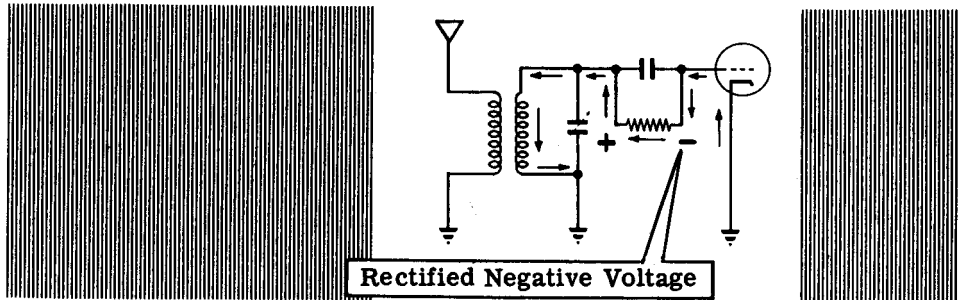

Note that this is basically the circuit of the diode detector. The control grid of the triode is taking the place of the diode plate, the grid-leak resistor has replaced the diode load or earphones, and the grid capacitor is acting as an RF filter capacitor across the load.

When a modulated signal voltage is applied to this circuit, the grid will attract electrons from the cathode during the positive half-cycles. The flow of current through the grid-leak resistor to ground produces a voltage drop across the grid-leak resistor. Because of the fact that current can flow in only one direction in the grid circuit, this voltage remains constant in polarity. The grid is thus biased, or kept at a negative voltage with respect to the cathode. The amount of bias will vary in accordance with the amplitude or modulation of the signal. In other words, the bias will vary at an audio-frequency rate.

## The Grid-Leak Detector (continued)

Suppose you consider the complete grid-leak detector circuit.

## *Schematic of a grid-leak detector*

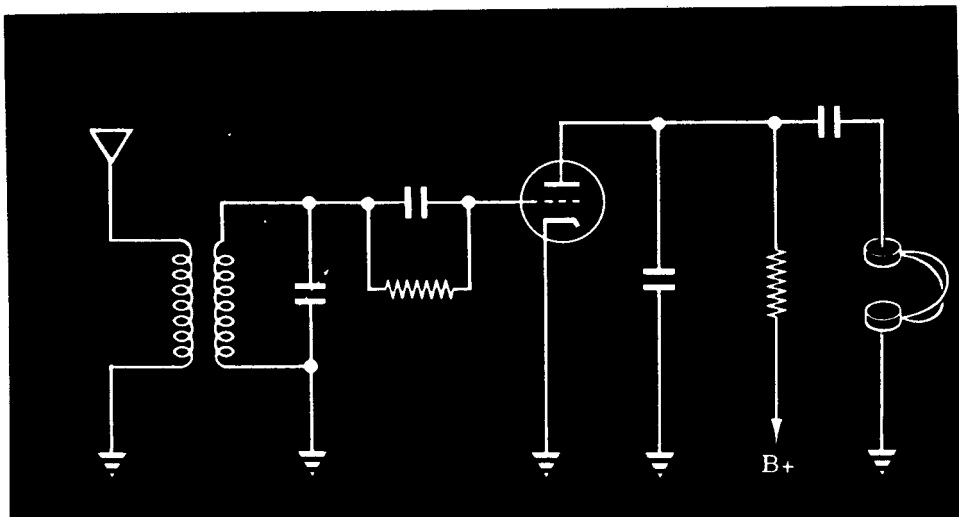

You will recall that the plate current of a triode is dependent upon the grid voltage. Consequently the audio frequency variations in bias should produce a corresponding pulsating plate current. Any radio frequency component of the plate current is filtered out by capacitors and RF chokes placed in the plate circuit. As a result, the voltage developed across the plate load is an amplified reproduction of the audio frequency voltage developed across the grid-leak resistor.

When there is no incoming signal, no bias is produced. Consequently, the plate current is high when no signal is being detected. When a signal is received, the grid becomes biased negatively and the average amount of plate current decreases.

The amount of grid bias developed is equal numerically to the amount of grid current multiplied by the amount of resistance of the grid-leak. Therefore the larger the grid-leak resistor, the greater will be the amplitude of the signal developed. For that reason, extremely sensitive grid-leak detectors usually use grid-leak resistors whose values are between one and five megohms.

However, if a strong signal comes in, it is quite possible that enough bias may be created to cut off the flow of plate current during part of the cycle, thus producing distortion. In order to reduce this distortion, grid-leak power detectors are used. They are designed for use with more powerful signals and generally employ smaller resistors in the grid circuit.

The Regenerative Detector

The regenerative detector, which is extremely sensitive, is a modification of the grid-leak detector. It utilizes the principle of regeneration, or strengthening the signal by feeding the amplified signal produced in the plate circuit back to the grid. From your work with oscillators you should have acquired an understanding of the nature and importance of regeneration. A regenerative detector is nothing more than a combination of an oscillator and a grid-leak detector. If you understand the operating principles of each of those circuits, the regenerative detector should give you very little trouble.

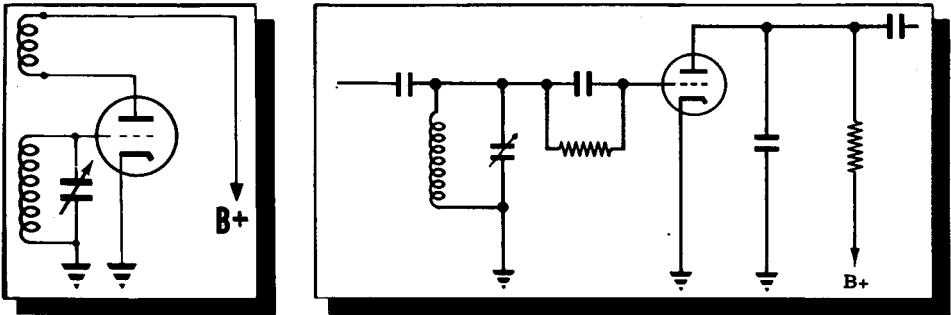

*An Oscillator + A Grid-Leak Detector*

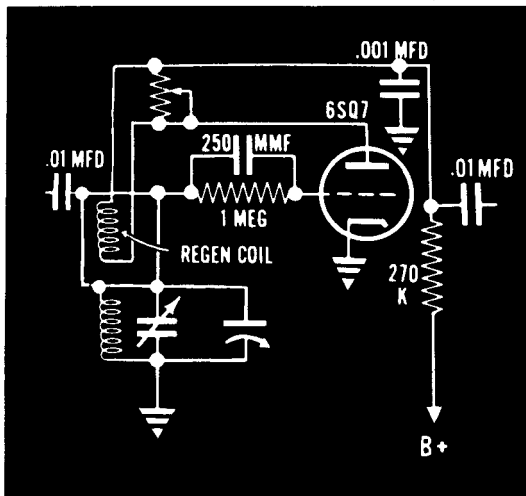

*= A Regenerative Detector*

## TRF RECEIVERS—REGENERATIVE DETECTOR

### How the Regenerative Detector Works

The regenerative detector circuit is similar to that of the grid-leak detector except for the coil in the plate circuit and the variable resistor across the coil. This circuit is shown on the previous sheet.

The plate coil, sometimes called the "tickler coil," feeds back voltage to the grid circuit in phase with the incoming signal voltage, thus increasing the voltage gain and sensitivity of the detector. The variable resistor is placed across the coil to control the amount of feedback or regeneration.

Why control the amount of feedback? The answer becomes obvious if you consider that when feedback becomes excessive, a circuit will begin to oscillate and produce squeals and howls. On the other hand, if there isn't enough feedback, this detector is hardly any more sensitive than the grid-leak detector. Control of feedback enables us to avoid the two extremes and strike a happy medium.

There are many ways of controlling the amount of feedback. One method which has been used involves varying the physical position of the tickler coil with respect to the grid coil. If the coupling between the two coils is reduced by moving the tickler coil away from the grid coil, or rotating it so that its axis is at an angle to the axis of the grid coil, the amount of feedback will be reduced. When this method is used to control feedback, a potentiometer is not connected across the tickler coil.

### ARRANGEMENT TO VARY COUPLING BETWEEN TICKLER AND GRID COIL

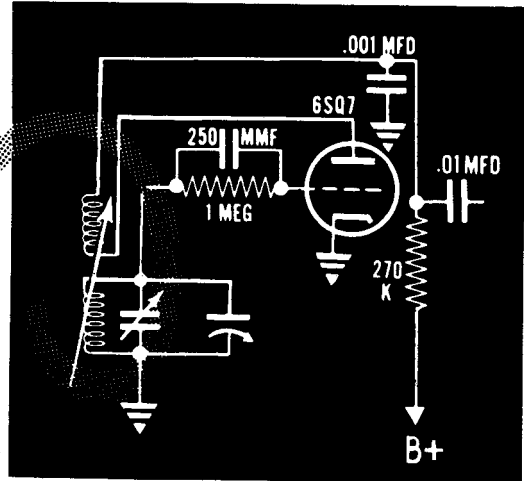
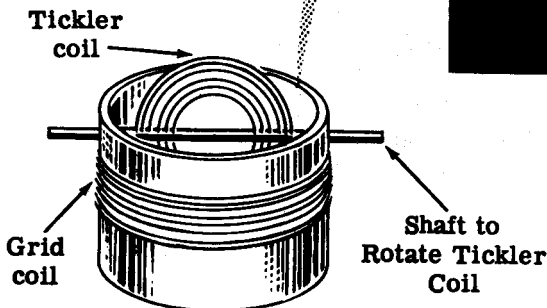



## TRF RECEIVERS—REGENERATIVE DETECTOR

### How the Regenerative Detector Works (continued)

Another method of regeneration control makes use of a variable capacitor which is placed between one side of the tickler coil and ground. Decreasing the size of the capacitor, reduces the amount of RF energy available in the plate circuit for regeneration.

#### REGENERATION CONTROL EMPLOYING A VARIABLE CAPACITOR

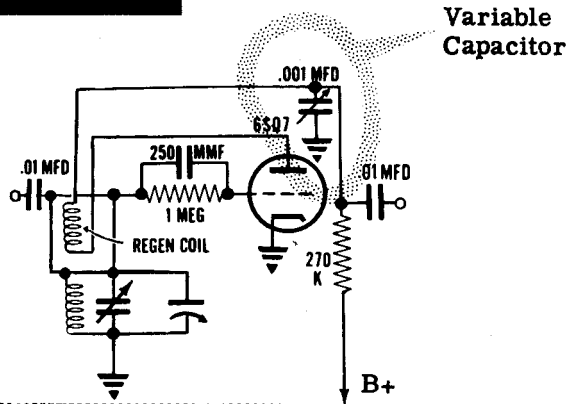

#### REGENERATION CONTROL EMPLOYING A VARIABLE RESISTOR

Variable Resistor

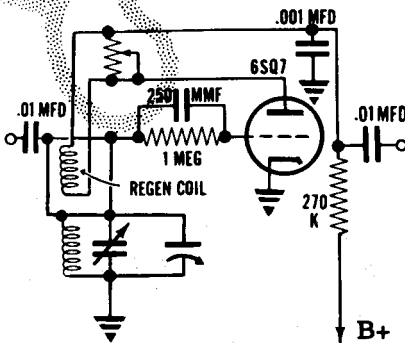

In the detector shown above, regeneration is controlled by a variable resistor placed across the tickler coil.

When the movable arm of the potentiometer is in the upper position, the tickler coil is effectively shorted out and there is no regeneration. The detector is now, for all practical purposes, a grid-leak detector. When the potentiometer arm is moved to the other extreme position, most of the RF current will flow through the tickler coil rather than through the potentiometer. As a result, the circuit will probably begin to oscillate.

## TRF RECEIVERS—REGENERATIVE DETECTOR

### How the Regenerative Detector Works (continued)

No matter what method is used to control regeneration, the control is usually advanced as far as possible without producing oscillations. In actual practice this is accomplished by tuning in a station, just as with any other type of detector. Then the regeneration control is turned up to the point at which whistles, howls and clicks are heard. This indicates that the detector is oscillating. The regeneration control is then turned back to the point where these interfering sounds just disappear. The regenerative detector is properly adjusted for maximum selectivity and sensitivity. This process of adjusting the regeneration control must be repeated each time a new signal is tuned in.

The regenerative detector is the most sensitive detector capable of receiving amplitude-modulated signals. The familiar walkie-talkie, used so successfully during the last war, employed a modified regenerative detector circuit.

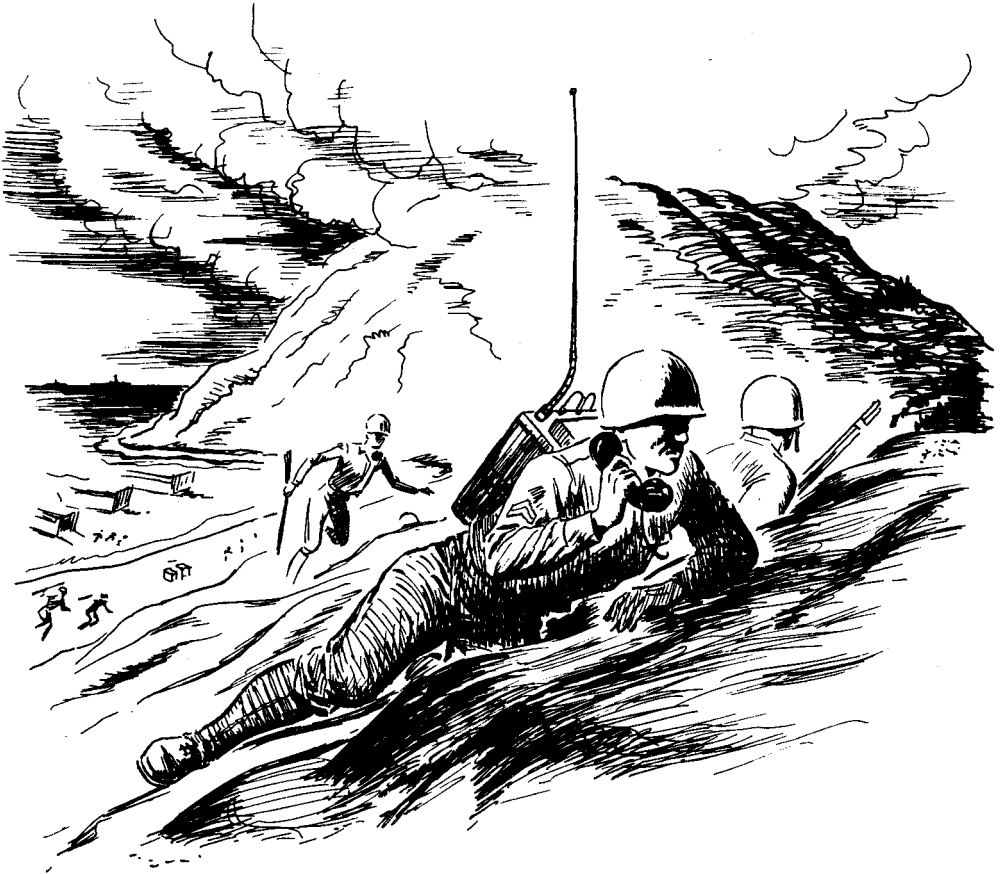

## TRF RECEIVERS—REGENERATIVE DETECTOR

### The Regenerative Detector as a CW Receiver

You may recall from your study of transmitters that there are several methods of impressing intelligence upon a carrier wave. One of these methods is known as "amplitude modulation." The crystal, diode and grid-leak detectors we have considered up to this point are designed for use with amplitude-modulated (AM) signals. Another method of conveying intelligence involves the interruption of a carrier wave in accordance with a code such as the Morse Code. These signals are called "interrupted continuous wave" or "CW signals." Since there is no modulation in this type of signal, it cannot be detected by crystal, diode or grid-leak detector circuits. In order to hear the signal, it is necessary to use a detector which employs the heterodyne principle. The heterodyne principle involves mixing the CW signal with a signal obtained from an oscillator. The result of this mixing is an AM signal which is interrupted in the same manner as the original CW signal. This AM signal can then be detected and the familiar "dit-dah" sound of code will be heard in the earphones.

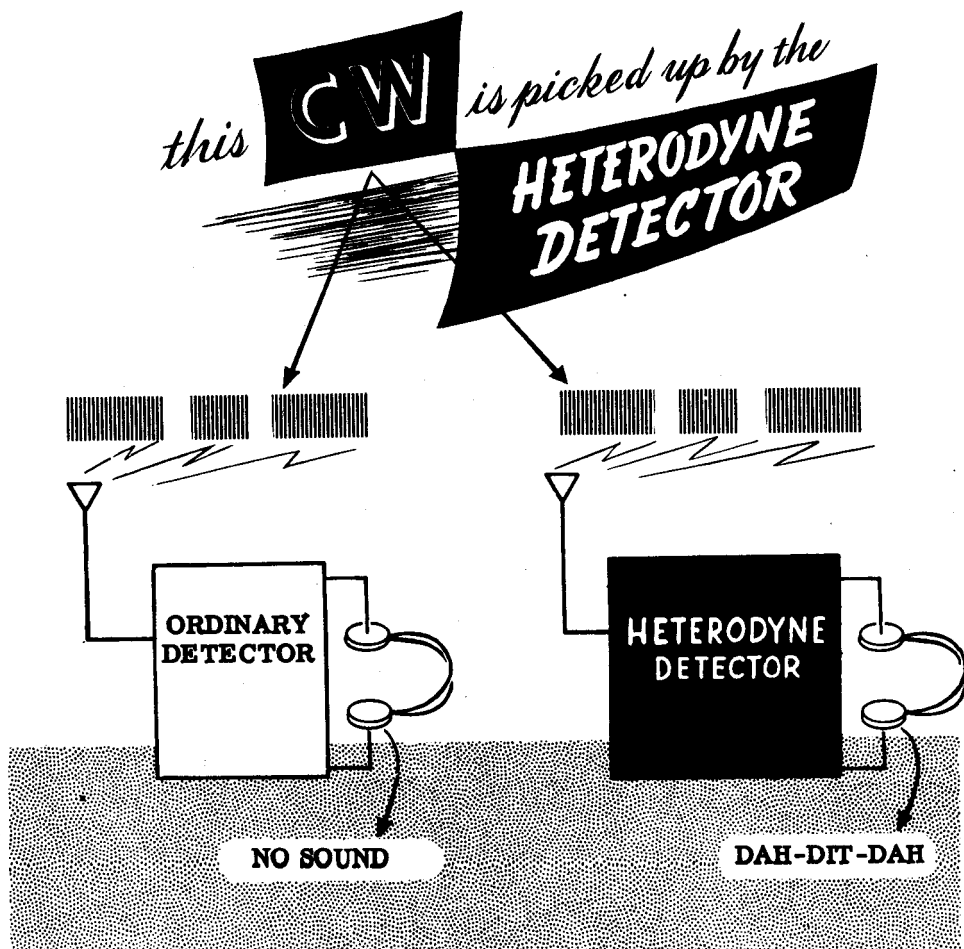

# TRF RECEIVERS—REGENERATIVE DETECTOR

## The Regenerative Detector as a CW Receiver (continued)

You may have observed that when two adjacent piano keys are struck at the same time, a distinct throbbing sound can be heard. This throbbing sound, known as a beat, has a frequency equal to the difference of the frequencies of the two notes struck. If the two notes struck have frequencies of 264 and 297 cycles respectively, the beat frequency will be equal to the difference between them, or 33 cycles.

Similarly, when two alternating voltages of slightly different frequencies are combined in a detector, the resultant wave circuit produced in the output will have a frequency which is equal to the difference between the frequencies of the two original voltages. This is the basis of the heterodyne principle.

For example, if two inaudible RF waves whose frequencies are 600 kc and 601 kc, respectively, are applied to a detector tube, the smaller wave (A) will add and subtract from the larger wave (B) to make the amplitude of the larger wave (B) vary in the manner shown. The rate of variation of the amplitude of wave B is the difference between the frequencies of the two waves—in this case 1 kc. Observe that wave B, because of the introduction of wave A, has been transformed into an amplitude-modulated wave. The audio modulation can be heard by detection of this AM signal.

## *The Heterodyne Principle*

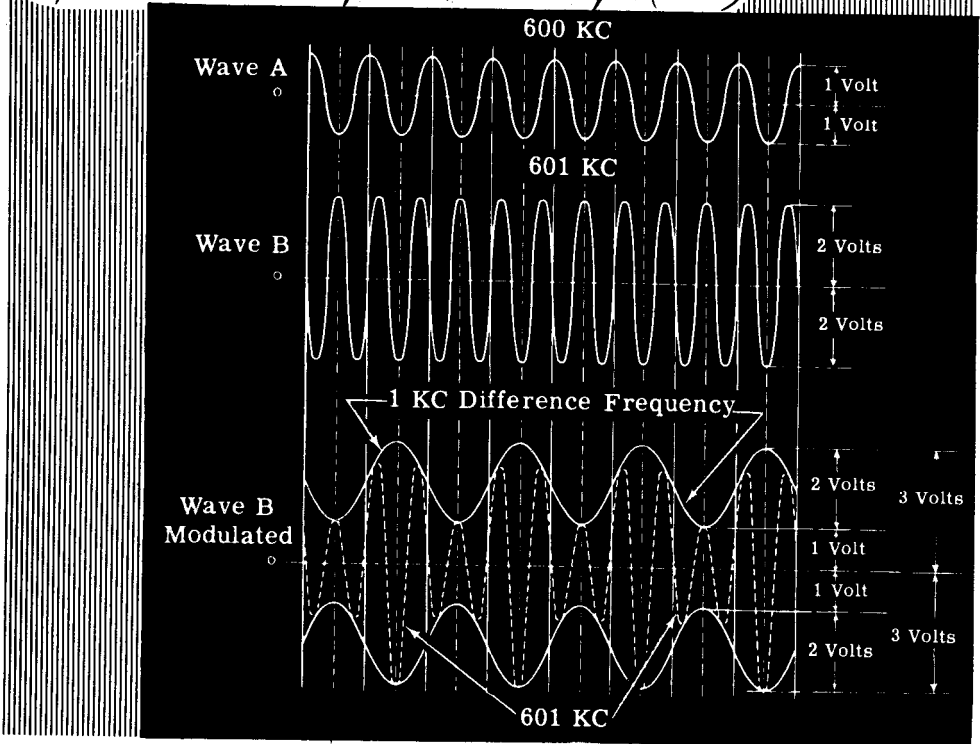

# TRF RECEIVERS—REGENERATIVE DETECTOR

## The Oscillating Detector

Some receivers designed for reception of CW signals employ a separate local oscillator known as a "beat-frequency oscillator" or "BFO." If the output of this oscillator is heterodyned against a continuous radio wave which is interrupted in accordance with the Morse Code, the audio beat note that is produced will be interrupted in a similar manner. In this way, the heterodyne principle makes possible the detection of CW signals. The heterodyne principle will also be applied in a later lesson dealing with the superheterodyne receiver.

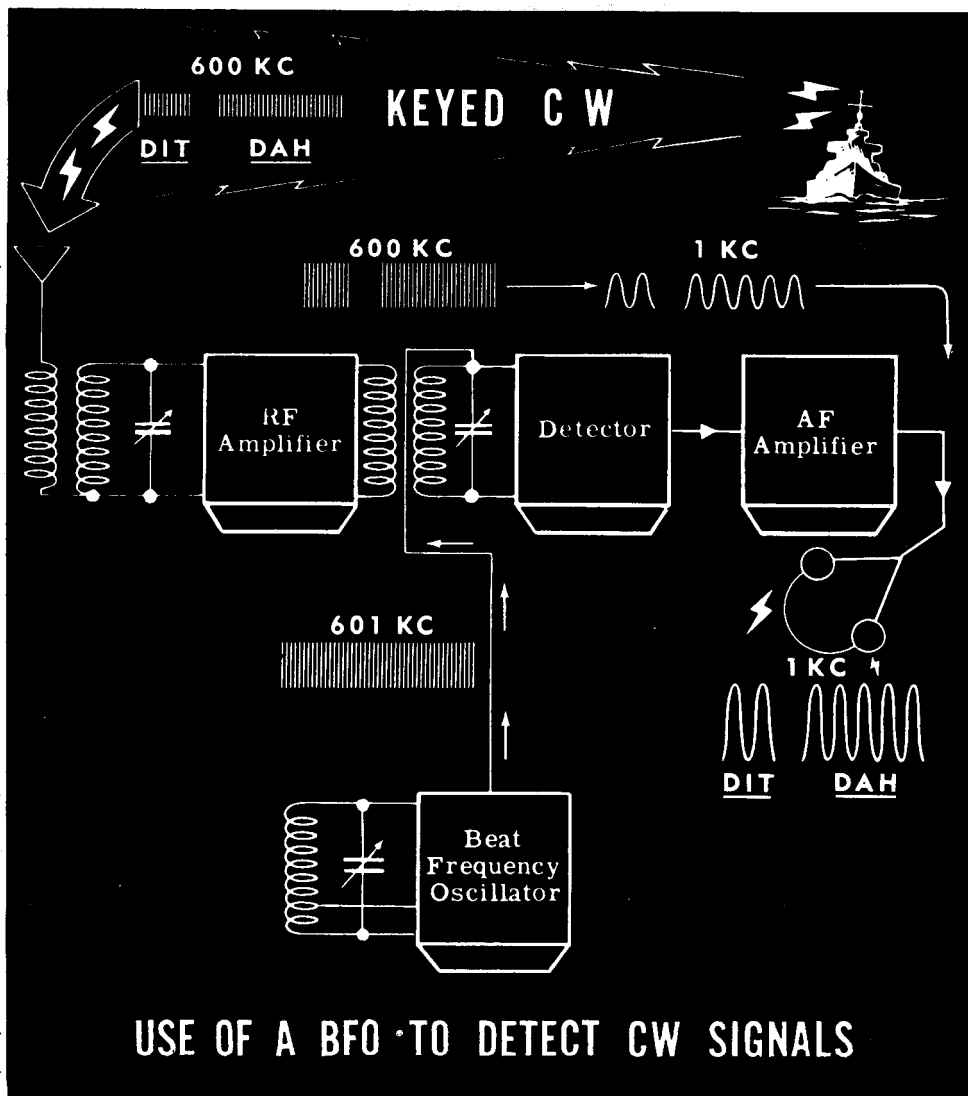

# TRF RECEIVERS—REGENERATIVE DETECTOR

## Analysis of the Regenerative Detector Circuit

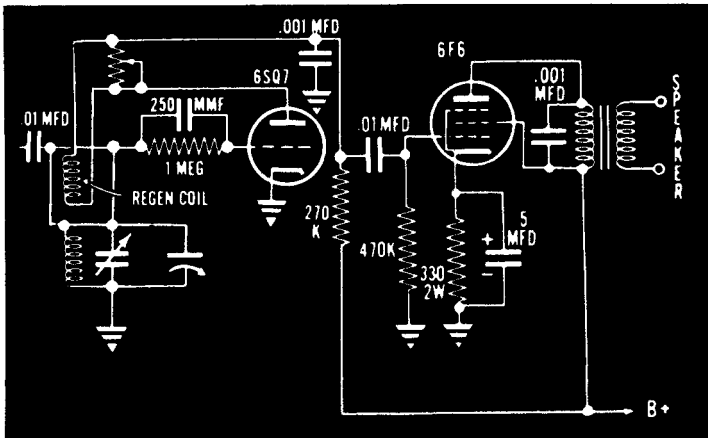

You know how the RF and AF amplifiers work. Suppose you review the functions of the various component parts used in the regenerative detector.

The .01-mfd capacitor found in the grid circuit is used to couple the preceding RF amplifier stage to the detector. The grid coil and variable capacitor provide tuning and selectivity. The 1-megohm resistor provides grid-leak bias while the 250-mmfd capacitor acts as an RF bypass capacitor around the grid-leak resistor. The plate or tickler coil is inductively coupled with the grid coil and thus provides feedback, while the potentiometer across the tickler coil controls the amount of feedback. The .001-mfd capacitor is an RF filter or bypass capacitor around the 270K plate load resistor, and the .01-mfd capacitor in the plate circuit is used to couple the detector to the following AF amplifier stage.

### COMPONENTS

### FUNCTIONS

COMPONENTS	FUNCTIONS
.01-mfd capacitors	Couple detector to preceding and following stages
Coil and variable capacitor	Provide selectivity
1 megohm resistor	Provides grid-leak bias
250-mmfd capacitor	Bypasses RF around grid-leak resistor
Regeneration coil	Provides feedback
500K potentiometer	Controls feedback
.001-mfd capacitor	Filters RF component of signal
270K resistor	Acts as plate load of detector

# TRF RECEIVERS—REGENERATIVE DETECTOR

## Review of Detectors

You have become acquainted with the basic principles of operation of four important types of detectors. We will now review the basic circuits and operating characteristics of each type.

### CIRCUITS

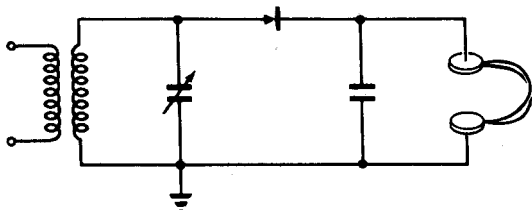

CRYSTAL DETECTOR

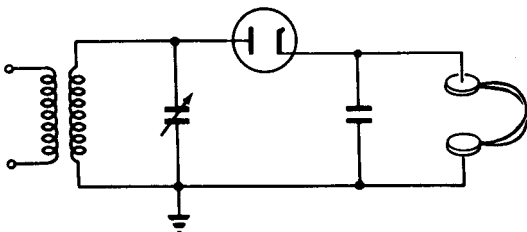

DIODE DETECTOR

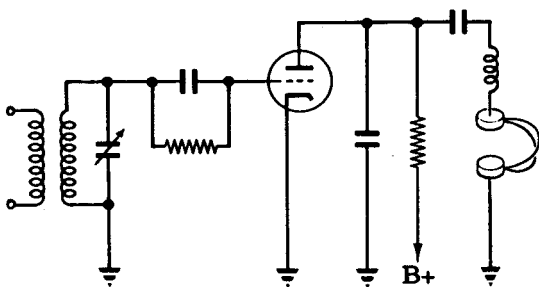

GRID-LEAK DETECTOR

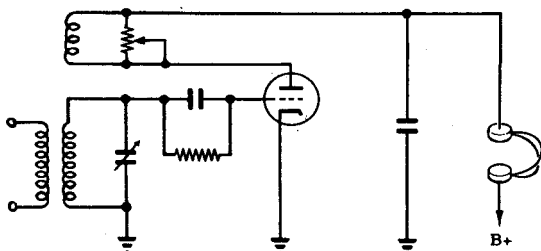

REGENERATIVE DETECTOR

### CHARACTERISTICS

Low sensitivity  
 Poor selectivity  
 Good fidelity  
 Low reliability  
 Capable of handling strong signals  
 Simple and economical to operate

Low sensitivity  
 Poor selectivity  
 Excellent fidelity  
 High reliability  
 Capable of handling strong signals  
 Capable of supplying AVC voltages

High sensitivity  
 Poor selectivity  
 Low fidelity  
 Moderate reliability  
 Easily overloaded by strong signals  
 Plate current decreases when a signal is received

Extremely high sensitivity  
 Excellent selectivity  
 Very poor fidelity  
 Low reliability  
 Easily overloaded by strong signals

# TRF RECEIVERS—PLATE DETECTOR

## How the Plate Detector Works

The plate detector employs a triode or pentode biased at, or near, cut-off. The bias is usually provided by means of a cathode bias resistor, or less frequently, by means of a bias battery placed between grid and cathode. The plate current will be at, or near, zero when no signal is being received.

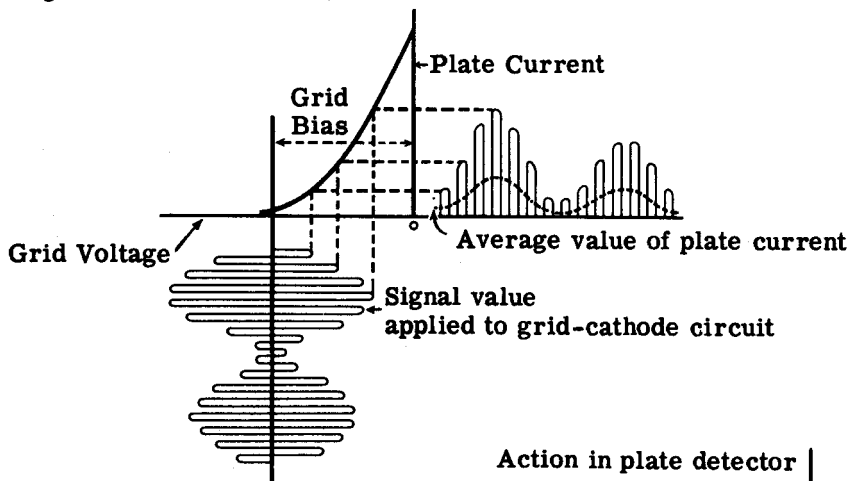

Action in plate detector

When a modulated RF signal is impressed on the grid, there will be a pulse of plate current during the positive half cycle and little or no plate current during the negative half cycle. The plate current will contain an amplified and rectified version of the input signal. The filtering of the RF component is accomplished by connecting a small capacitor between the plate and ground and an RF choke in series with the plate load. It is important that a small capacitor be used, since a capacitor that is too large will tend to filter out the higher audio frequencies as well as the radio frequencies.

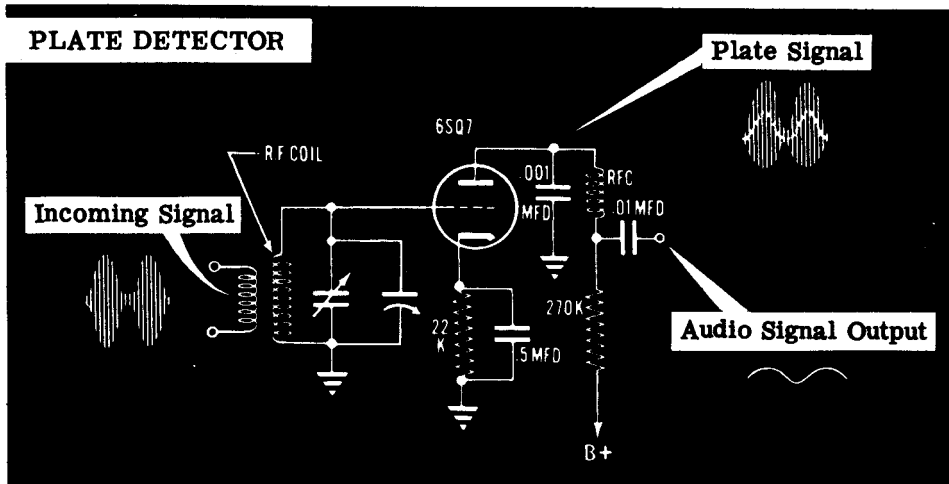



## TRF RECEIVERS—PLATE DETECTOR

### How the Plate Detector Works (continued)

In contrast with the action of the grid-leak detector, plate current in the plate detector is at a minimum with no incoming signal. Up to a certain point, the average plate current increases in direct proportion to the amplitude or strength of the signal impressed on the grid. Another important characteristic is that if care is taken not to drive the grid positive, the plate detector will consume no input power and there will be no loading effect upon the tuned circuit. Consequently the selectivity and fidelity of the plate detector surpasses that of the grid-leak detector.

On the other hand, among the disadvantages of the plate detector may be listed the fact that its sensitivity to weak signals is much less than that of the grid-leak detector. It also produces more distortion than the diode detector and it cannot directly provide a voltage to be used for automatic volume control.

The receiver shown below is a TRF receiver containing a plate detector. It also contains a beat-frequency oscillator to provide for reception of CW signals. The tuning capacitor of this oscillator is ganged with the RF amplifier stages in such a manner that a beat note of 1000 cycles will be heard when the receiver is tuned to a CW signal.

### RECEIVER EMPLOYING A PLATE DETECTOR

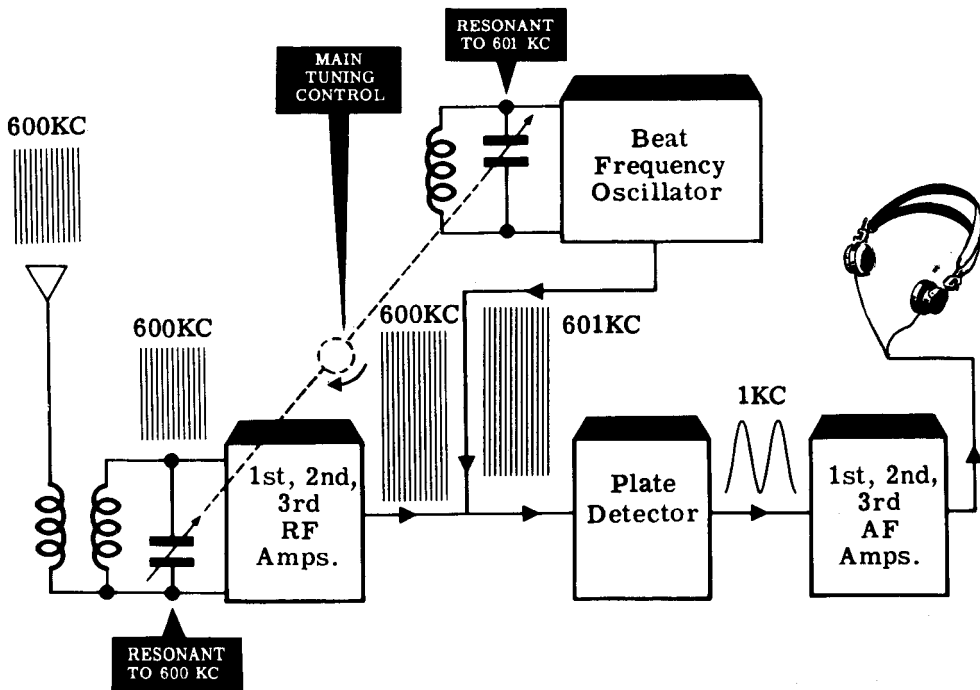

## TRF RECEIVERS—PLATE DETECTOR

### Analysis of the Plate Detector Circuit

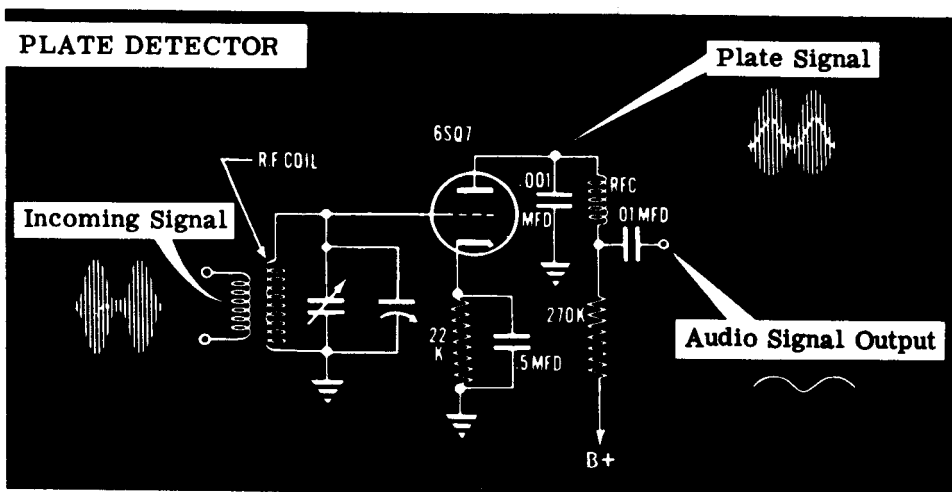

A brief analysis of the functions of the components used in the plate detector should help you to understand how this detector operates.

The coil and variable capacitor in the grid circuit form a tuned circuit and are obviously intended to provide selectivity. In addition, the grid coil of the detector is inductively linked with the plate coil of the preceding RF amplifier and thus couples these two stages. The 22K resistor in series with the cathode acts as the cathode bias resistor, biasing the tube almost to the point of cut-off, while the 0.5-mfd capacitor acts as a bypass capacitor around the cathode bias resistor. The RF choke and .001-mfd capacitor in the plate circuit serve to filter out the RF component of the signal while the 270K plate load resistor and the .01-mfd capacitor couple the detector to the following AF amplifier stage.

COMPONENTS	FUNCTIONS
RF coil and variable capacitor	Provide selectivity and couple detector to preceding RF amplifier stage
22K resistor	Provides cathode bias
0.5-mfd capacitor	Bypasses signal around cathode bias resistor
.001-mfd capacitor and RF choke	Filter RF component of signal
270K resistor	Acts as plate load of detector
.01-mfd capacitor	Couples detector to following AF amplifier stage

# THE SUPERHETERODYNE RECEIVER

## Introduction

The superheterodyne receiver is the most popular type of receiver in use today. Practically all commercial home radios are of this type. You will find either a superheterodyne circuit or a TRF circuit in practically every piece of electronic equipment that contains a receiver. This includes radar, sonar, communications gear—any device that picks up and receives a signal.

Knowing the TRF receiver gives you a good start toward learning the superheterodyne, because it uses all the basic components of a TRF—with three additional units. See the block diagram of a superheterodyne, showing the three additional units—mixer, local oscillator and intermediate frequency (IF) amplifier—which are in addition to the basic TRF circuit.

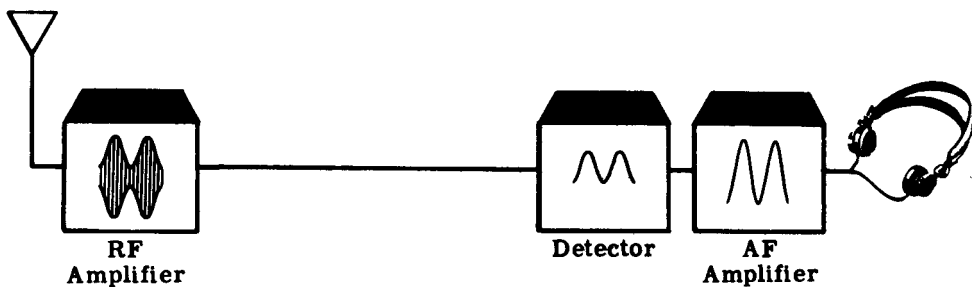

THE TRF RECEIVER

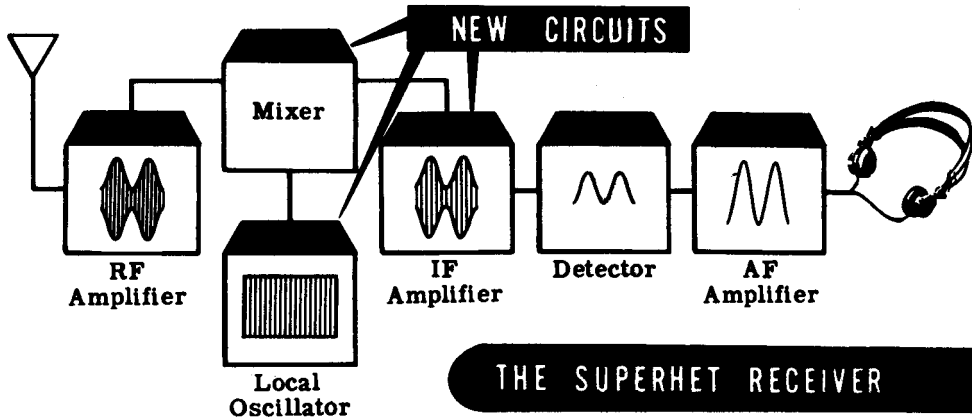

THE SUPERHET RECEIVER

# THE SUPERHETERODYNE RECEIVER

## The Superhet at High Frequencies

At high frequencies, the TRF receiver does not work as well as it does at lower radio frequencies. Above 20 mc, a conventional RF amplifier does not have the necessary sensitivity and selectivity.

The superheterodyne receiver avoids the difficulties encountered with the TRF at high frequencies by converting the selected signal frequency to a lower (intermediate) frequency (IF) which can be amplified more easily.

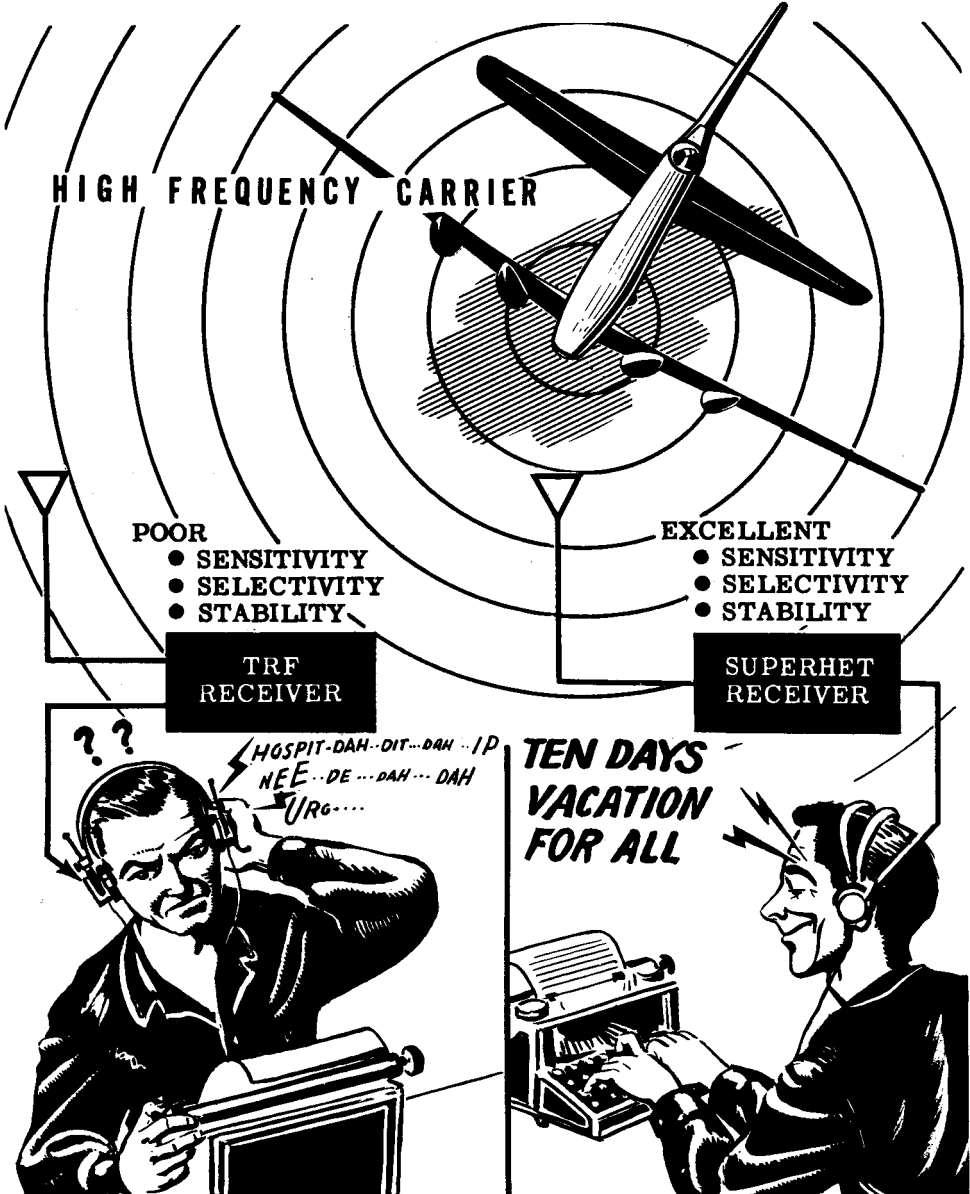

## THE SUPERHETERODYNE RECEIVER

### How the Superhet Works

If you know why the superheterodyne was developed, you will easily learn how it works. TRF receivers use RF amplifiers with variable tuned circuits to select and amplify the received signal. If the receiver has three RF stages before the detector, it will contain four tuned circuits. For the best selectivity and sensitivity, each of these four tuned circuits must be tuned to the same frequency. However, it is extremely difficult to make a multi-ganged tuning capacitor so that each section will tune its circuit to exactly the same frequency as the other sections. Therefore, the gain and selectivity of the TRF receiver is limited since more RF stages cannot be added conveniently.

The superheterodyne receiver overcomes this problem. It takes the incoming signal and converts the carrier frequency to another frequency. This new frequency is called the "intermediate frequency" (IF) and it does not vary regardless of the frequency to which the receiver is tuned. The IF signal is amplified in a series of high-gain amplifiers which are pre-tuned to this fixed IF frequency. Because it eliminates the many-ganged tuning capacitor, the superhet with its fixed frequency IF amplifiers can be used to give very large gains and very fine selectivity.

This is how the signal frequency is changed in the superhet. The incoming signal and the CW output of the local oscillator are fed into the mixer tube. The plate current is varied according to both of these signals which are of different frequencies. A beat (or difference) frequency appears in the resulting signal. This signal is then passed through the IF amplifiers which are tuned to this difference frequency. The IF signal has exactly the same modulation as the RF carrier. The only change has been the substitution of the IF frequency for the RF.

### THE SUPERHET RECEIVERS MAKE USE OF . . .

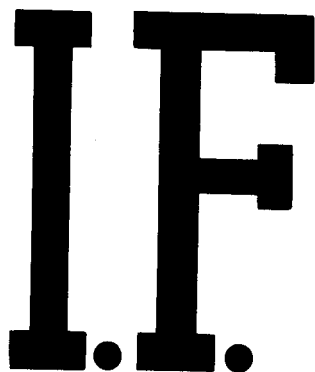

**I.F.**

**AMPLIFIERS**

**THIS MEANS —**

- 1. Greater Sensitivity*
- 2. Greater Selectivity*

## THE SUPERHETERODYNE RECEIVER

### Selectivity of the Superhet

This is what happens in a home superheterodyne radio set. When you tune it to a station of 880 kc, you are setting the tuned RF circuit to 880 kc and at the same time you are automatically tuning the local oscillator to 1336 kc. Two signals—one of 880 kc, the other of 1336 kc—are fed into the mixer stage. The output of the mixer stage contains a frequency of 456 kc which is the difference of its two inputs.

If at the same time the antenna picks up another station at a frequency of 1100 kc, the signal, if strong enough, can get by the first tuned circuit and would be mixed with the local oscillator output in the mixer stage. This undesired signal of 1100 kc would produce a beat-frequency of 1336-1100 or 236 kc.

The IF amplifier tuning, however, does not vary. It is always tuned to 456 kc. So you can see that only the beat signal produced by the desired station (880 kc) will be amplified by the IF amplifier. Since the undesired signal of 1100 kc produced a beat-frequency which is different from the IF frequency, its beat signal is not amplified. Thus, the superhet has selected the proper input signal on the basis of the frequency of the beat signal produced in the mixer stage.

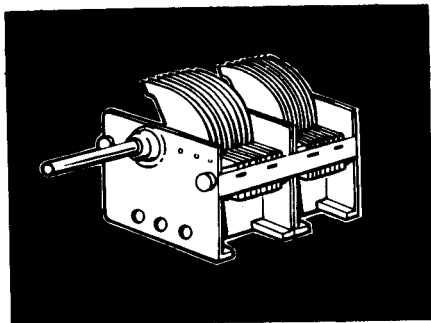

### THE *ganged* *tuning capacitor*

KEEPS THE LOCAL OSCILLATOR

"TRACKING" THE TUNED RF

In order to hear the 1100-kc station, the receiver would have to be re-tuned. Turning the knob changes the frequency to which the RF amplifier is tuned and, at the same time, changes the local oscillator frequency. A two-section ganged tuning capacitor does the trick. Tuning the receiver does not affect the IF stages. When the RF tuned circuit is set at 1100 kc, the oscillator will be putting out a signal of 1556 kc; the IF remains at 456 kc.

Now it is the 1100-kc signal which produces the 456-kc beat-frequency. The beat produced by the 880-kc signal would be the difference between its frequency and the 1556-kc local oscillator frequency—676 kc—and this frequency will not be amplified by the IF stages.

In order for the superhet to work properly, the local oscillator must be adjusted so that it will always tune to a frequency which is a fixed number of kilocycles different from the desired RF frequency. Thus, as the receiver—that is, the RF tuned circuit—is tuned from 550 to 1600 kc, the local oscillator should tune from 1006 to 2056 kc. Then, any signal picked up at the frequency to which the receiver is tuned will produce an IF frequency of 456 kc (which is the standard IF frequency for commercial receivers).

# THE SUPERHETERODYNE RECEIVER

## RF Amplifier Stage

Many superhet receivers do not contain an RF amplifier stage. In such receivers the signal from the antenna is fed to the signal grid of the mixer or converter stage. However, you will encounter other receivers which contain stages of RF amplification preceding the mixer. You will therefore have a better understanding of the operation of superhet receivers if you know the reasons for including an RF amplifier stage.

The first function of the RF amplifier is to improve the signal-to-noise ratio. The mixer stage usually produces more tube noise than an RF stage of amplification. The signal, plus the tube noise, is amplified by the following IF amplifier stage. However, if the signal strength is increased by placing an RF amplifier stage before the mixer, less amplification is required in the IF amplifier stage. Since tube noises produced by the mixer are not amplified as much as they were when no RF stage was present, a greater signal-to-noise ratio is obtained.

The second function of the RF amplifier stage is related to radiation from the oscillator stage. It should not be forgotten that this oscillator is a low-powered transmitter. If there is no RF amplifier stage, the oscillator is connected through the mixer stage to the antenna. This antenna will radiate some energy from the oscillator. This radiated signal may cause interference with reception in nearby receivers and may also divulge the location of the receiver. This radiation may be reduced or prevented by using one or more stages of RF amplification, and by carefully shielding the oscillator stage.

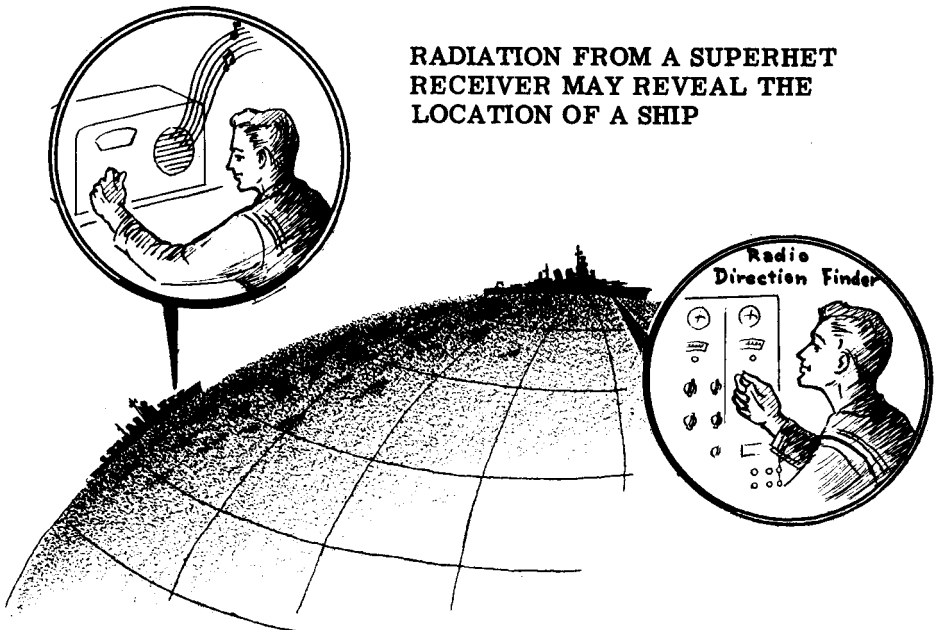

RADIATION FROM A SUPERHET RECEIVER MAY REVEAL THE LOCATION OF A SHIP

## THE SUPERHETERODYNE RECEIVER

### RF Amplifier Stage (continued)

The third function of the RF amplifier stage is concerned with selectivity. You will recall that in the TRF receiver the RF amplifier stages enabled the operator to select the desired signal from a group of signals whose frequencies were very close to each other. The RF amplifier in a superhet serves to prevent interference from a signal whose frequency may be several hundred kilocycles above that of the desired signal. This type of interference is called "image-frequency interference".

Let us assume that you have a superhet receiver without an RF amplifier stage and that the receiver is tuned to a station operating at a frequency of 600 kc. The oscillator in the receiver will be tuned to 1056 kc and the resulting IF signal will have a frequency of 1056 kc minus 600 kc or 456 kc. However, if there is a powerful station nearby, broadcasting at a frequency of 1512 kc, some of the signal from this station will enter the mixer stage where it will beat against the signal from the oscillator. The resulting signal will be 1512 kc minus 1056 kc or 456 kc—the same intermediate frequency as that produced by the desired station. The IF amplifier stage will amplify both signals equally well, since they are both at the correct frequency of 456 kc. This interference produces whistles and a confusing mixture of sounds coming out of the loudspeaker.

It should be noted that when the intermediate frequency is 456 kc, image interference is produced when there is a second station broadcasting at a frequency that is twice the intermediate frequency or 912 kc above that of the desired signal. Thus the image frequency of a station broadcasting on 600 kc is 912 kc higher, or 1512 kc. Image-frequency interference can be reduced by the use of an RF amplifier stage before the mixer. For this reason the RF amplifier is sometimes called a "preselector stage".

In any receiver in which images might present a problem, one tuned circuit is not enough to guarantee the elimination of this interference. There will be as many as two or three stages of RF amplification at the signal frequency before the signal is fed into the mixer. These stages are not as selective as those in a TRF, but are selective enough to discriminate between the desired signal and the image frequency. These stages, called "preselector" stages, do not present the alignment problems of the TRF since none of these stages need to be sharply tuned to the resonant frequency.

The preselector serves another purpose besides suppressing the image. It also isolates the antenna from the local oscillator so that there will be no possibility of the receiver radiating energy.



# THE SUPERHETERODYNE RECEIVER

## The Local Oscillator

In a superhet receiver circuit, the local oscillator is tuned by a variable capacitor ganged with the tuned RF circuit in the antenna input. The local oscillator is tuned to oscillate and put out a signal at a frequency that is above or below the RF frequency by a fixed difference for every position of the tuning dial—every received frequency. The local oscillator output is mixed with the RF carrier. The fixed frequency difference is the IF output of the mixer.

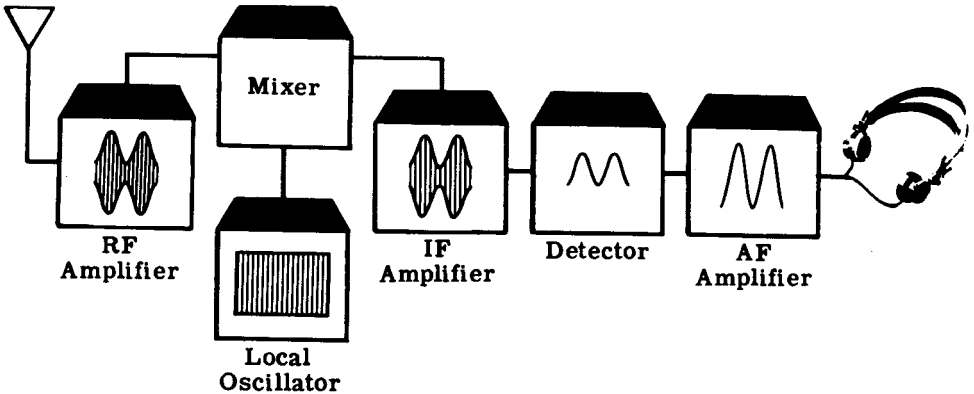

The process of mixing or beating two frequencies together to get a difference frequency is called "heterodyning." That is why the receiver was named superheterodyne.

The superhet you will discuss will have a tuned-grid type oscillator that operates at 456 kc above or below the RF frequency. The IF is 456 kc. The variable capacitor in the oscillator tank is ganged with the tuning capacitor in the antenna tuned circuit, as shown in the illustration of that section.

As the receiver is tuned to an incoming signal, the local oscillator is also varied to keep it at a frequency of 456 kc higher or lower than the signal to which the antenna circuit is tuned. The table below gives examples of typical operating frequencies.

### TYPICAL OPERATING FREQUENCIES FOR THE SUPERHET

FREQUENCY OF RF CARRIER	FREQUENCY OF LOCAL OSCILLATOR	IF DIFFERENCE FREQUENCY
550 kc	1006 or 94 kc	456 kc
710	1166 or 254	456
880	1336 or 424	456
1440	1896 or 984	456

# THE SUPERHETERODYNE RECEIVER

## The Local Oscillator (continued)

There are several types of oscillators that may be employed as local oscillators. However, the types most frequently used are modifications of the Armstrong tickler-coil and the Hartley oscillators. An ideal local oscillator should possess the following characteristics:

1. The frequency of its output should be stable and free from drift at all settings.
2. It should be capable of delivering considerable voltage to the mixer. This voltage should be approximately ten times greater than that of the RF signal.
3. The strength of the output should be constant over the entire frequency range.
4. The oscillator should have minimum interaction with other tuned circuits. If the oscillator interacts with other tuned circuits, there will be a change in oscillator frequency each time the other circuits are tuned.
5. The oscillator should radiate a minimum of energy into space.

The oscillators found in receivers used for broadcast band reception are usually designed to produce a signal whose frequency is 456 kc higher than the frequency of the incoming radio wave. The tuning capacitor of the oscillator is ganged with the capacitor of the RF tuned circuit so as to maintain a constant difference in frequency as the receiver is tuned across the band. This is known as "tracking." Perfect tracking is the condition when the oscillator tuned circuit is resonant exactly 456 kc higher than the RF tuned circuits for all settings of the tuning dial. The process of adjusting the tuned circuits, to maintain this constant difference at both the high and low ends of the tuning bands, is known as "aligning." The process of adjusting a receiver to obtain good tracking will be discussed more completely in the section dealing with the alignment and adjustment of superhet receivers.

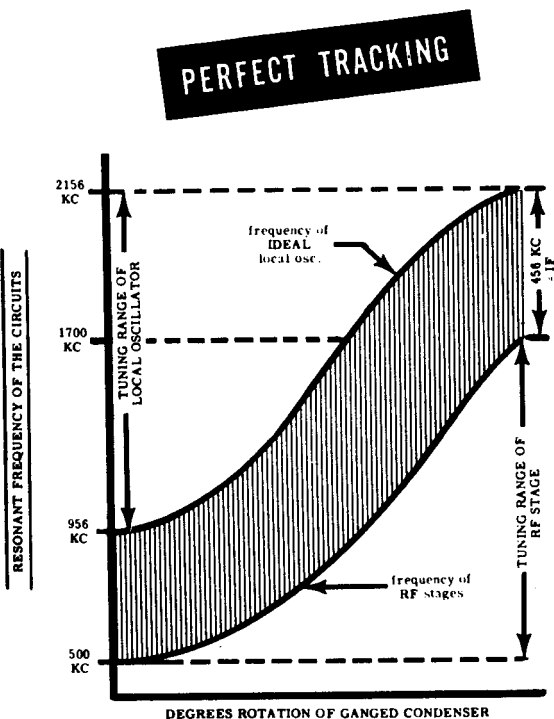

# THE SUPERHETERODYNE RECEIVER

## The Local Oscillator (continued)

There are two ways of designing the oscillator tank circuit so that it will produce a signal 456 kc higher than that of the RF circuit. One method employs a special kind of ganged capacitor. The plates of the oscillator section of this capacitor are made smaller than the plates of the RF section. Since the capacity of the oscillator section is less than that of the RF section, the oscillator section will resonate at a higher frequency. In addition, the plates of the oscillator section are shaped so as to produce correct tracking as the plates are meshed or unmeshed.

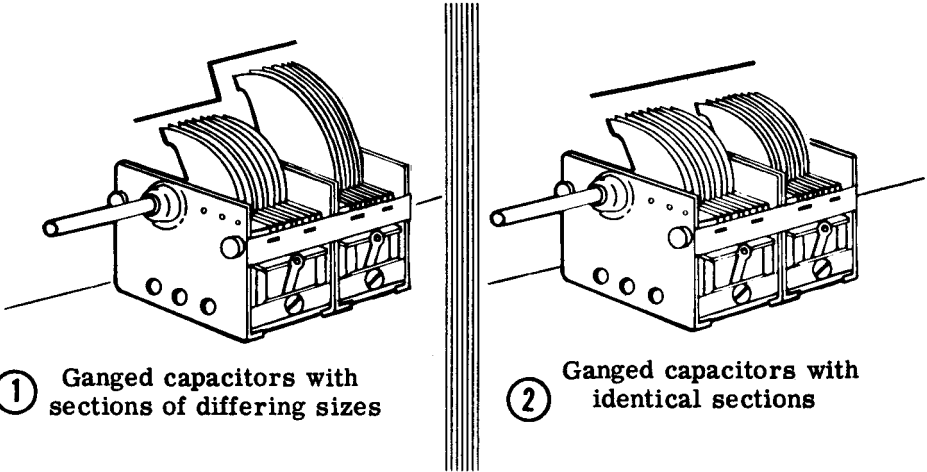

When both sections of the capacitor are identical, the total capacity of the oscillator tank circuit is reduced by placing an adjustable mica capacitor, called a "padder" capacitor, in series with the oscillator tuning capacitor. As a result of this reduction in capacity, the oscillator circuit resonates at a higher frequency. The capacity of the padder is usually between 500 and 1000 mmf. In the process of alignment, the padder capacitor is adjusted for perfect tracking at the low frequency end of the band.

In order to align the superhet receiver at the high frequency end of the band, trimmers are placed in parallel with each section of the tuning capacitor, just as they are in TRF receivers. These trimmers are adjustable mica capacitors whose capacity varies between 2 and 20 mmf.

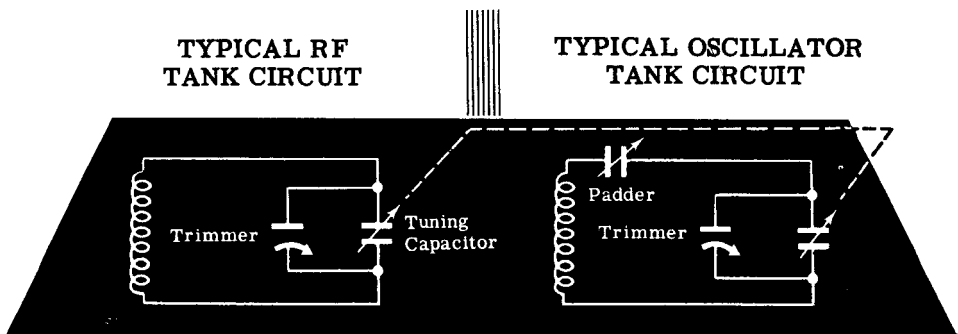

# THE SUPERHETERODYNE RECEIVER

## How the Mixer Stage Works

The mixer works on the following principle: If two different frequencies are mixed or combined in a tube, the output will contain four different frequencies which are:

1. The modulated RF signal from RF amplifier or antenna
2. The unmodulated local oscillator RF output
3. The sum of 1 and 2
4. The difference of 1 and 2

The difference frequency is the desired signal. This signal resulting from the mixing of a modulated carrier with the unmodulated output from the oscillator will have exactly the same modulation shape as the original carrier wave. Tuned circuits are used to amplify the desired signal and discriminate against the others.

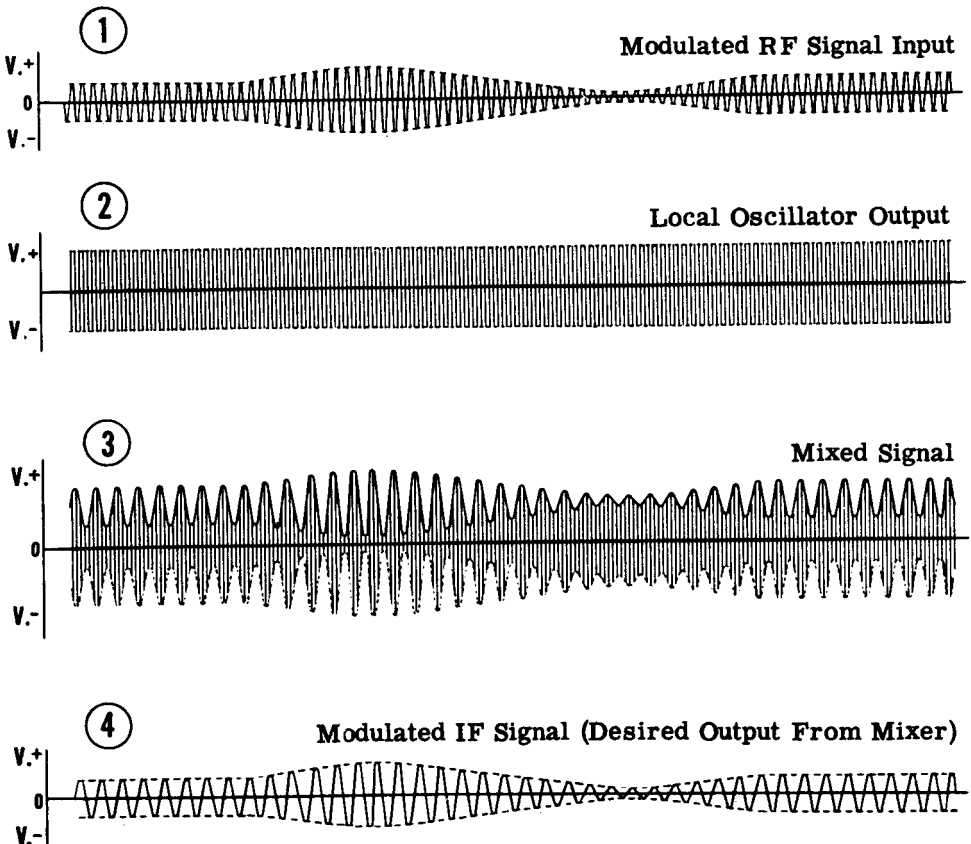

# THE SUPERHETERODYNE RECEIVER

## How the Mixer Stage Works (continued)

From among the several frequencies present in the plate circuit of the mixer tube—the original RF signal, the oscillator signal, a signal whose frequency is the sum of the first two signals, and another signal whose frequency is equal to their difference—only the latter or IF signal must be passed on to the next stage. This is accomplished by using the primary of a tuned IF transformer as the plate load. The primary and secondary coils are tuned to the intermediate frequency which generally is 456 kc. In this manner, maximum response is obtained for the IF signal. This IF signal is passed on to the following IF amplifier stage, while the other signals are rejected by the selective action of the tuned IF transformer.

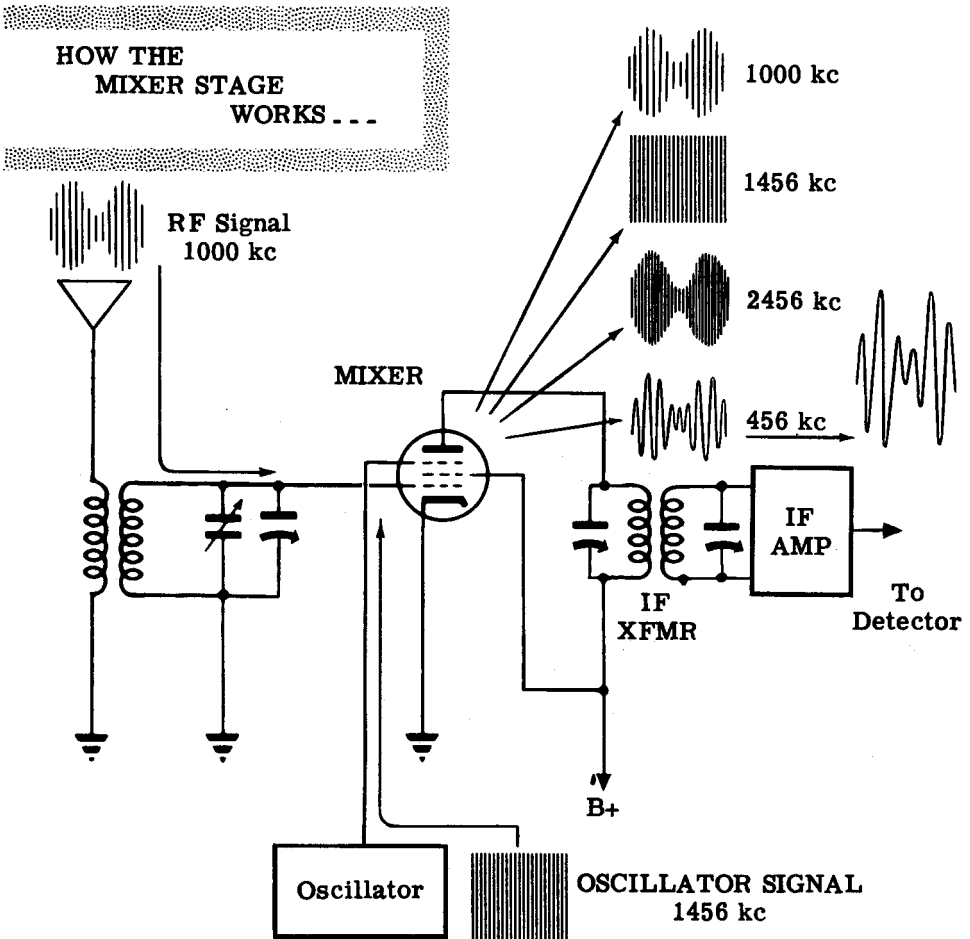

# THE SUPERHETERODYNE RECEIVER

## How the Mixer Stage Works (continued)

From the preceding discussion it may be seen that the principal function of the mixer or first detector stage is to act as a frequency converter. The input to this stage is a modulated RF signal whose frequency is relatively high. This signal is converted to a lower frequency modulated IF signal by means of the heterodyning action taking place in the mixer. The IF signal now possesses all the intelligence originally contained in the RF signal.

There are a large number of combinations of tubes and circuit components capable of serving as frequency converters. Among the tubes which may be employed are triodes, pentodes and pentagrid (five-grid) tubes. The oscillator may be coupled inductively or capacitively to either the cathode, control grid, screen grid, or suppressor grid of the mixer. It may even be coupled to a special grid, called the "injector" grid, which is found in certain types of mixer tubes. Some pentagrid tubes are designed to combine the functions of oscillator and mixer in one tube. They are then known as "pentagrid converters."

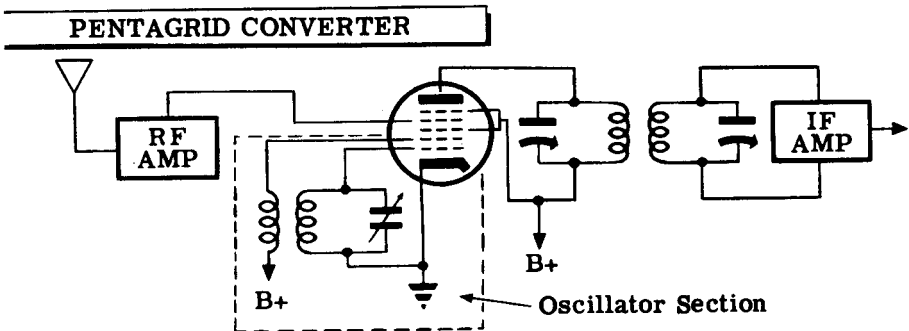
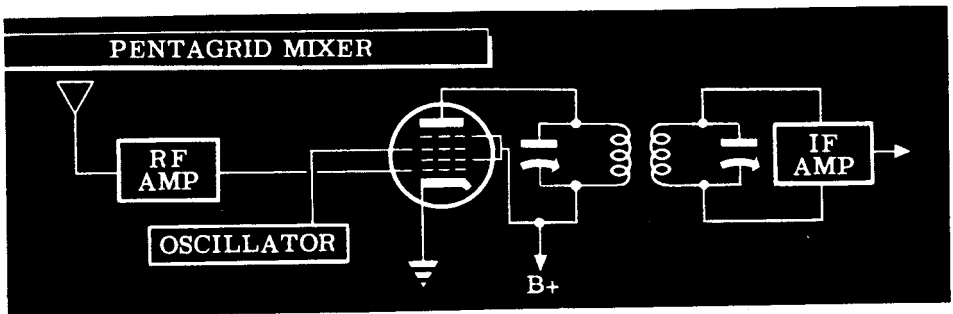
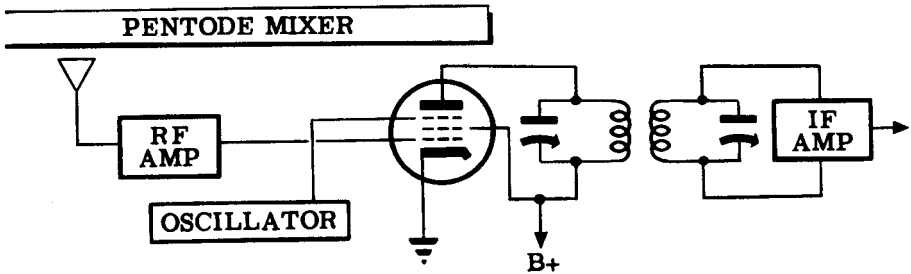

## THE SUPERHETERODYNE RECEIVER

### How the Mixer Stage Works (continued)

Most IF transformers are tuned by adjusting small mica trimmer capacitors to the correct frequency. This process of adjustment will be discussed later. The coils and capacitors are mounted in small metal cans which act as shields. Small holes in the tops of the cans make it possible to vary the value of the capacitors by turning adjusting screws without removing the shield.

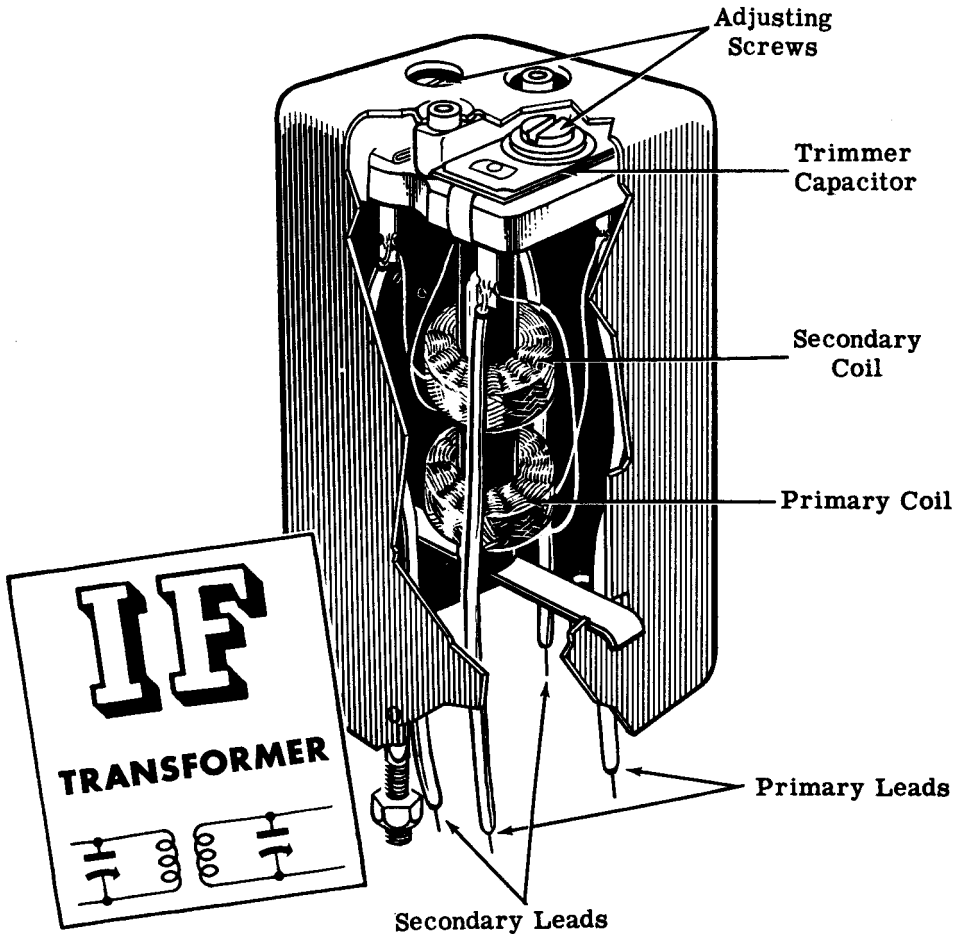

There are also some IF transformers that have powdered iron cores and fixed mica capacitors. Tuning is accomplished by turning a set screw which moves the iron core in or out of the coil. This type of transformer is known as a "permeability-tuned" transformer. No matter what method is used to tune the transformer, you will find that nearly all IF transformers are double tuned. This means that both primary and secondary are tuned to the intermediate frequency. This produces a very high degree of selectivity.

# THE SUPERHETERODYNE RECEIVER

## How the IF Amplifier Works

The intermediate-frequency amplifier is permanently tuned to the constant difference in frequency between the incoming RF signal and the local oscillator. The tuning of the IF amplifier stage is accomplished by means of two tuned IF transformers. The one associated with the grid circuit of the amplifier is called the "input" IF transformer, while the one associated with the plate circuit is called the "output" IF transformer. The tubes employed in IF amplifiers are generally variable-mu pentodes.

Since this amplifier is designed to operate at only one fixed frequency, the IF circuits may be adjusted for high selectivity and maximum amplification. It is in the IF stage that practically all of the selectivity and voltage amplification of the superhet is developed. Simple superhet receivers may contain only one IF amplifier, while more complex receivers contain as many as three IF amplifier stages.

The intermediate frequency used most often in superhet receivers is 456 kc, although intermediate frequencies as low as 85 kc and as high as 12,000 kc or higher have been used in special types of superhet receivers. Using a low intermediate frequency, such as 175 kc, results in high selectivity and voltage gain, but also increases the possibility of image-frequency interference. A high intermediate frequency reduces the possibility of image interference, but also reduces the selectivity and voltage gain. The choice of 456 kc as the intermediate frequency for most receivers represents a compromise between these two rather undesirable extremes.

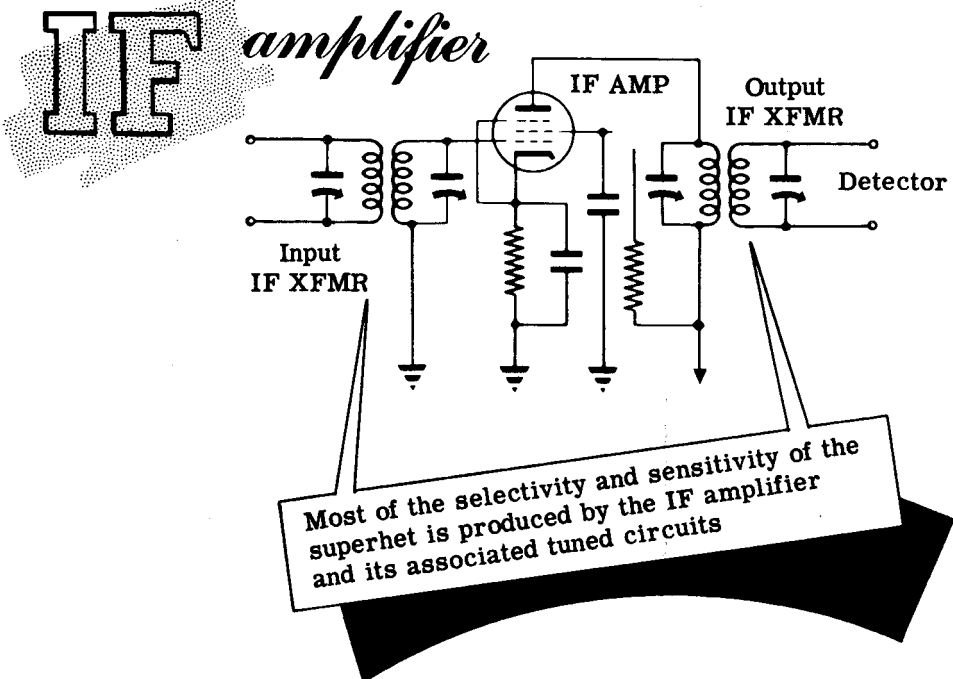



# THE SUPERHETERODYNE RECEIVER

## How the Detector Works

The conversion of the IF signal into an audio signal is accomplished by means of a diode detector. Since the mixer is sometimes called the "first detector," this diode detector is frequently referred to as the "second detector."

The second detector circuit in the superhet receiver will sometimes be combined in one tube with the first stage of audio amplification. The receiver's manual volume control and automatic volume control are also often included as part of the same tube circuit. The tube employed for this purpose may be a 6SQ7 which is a twin-diode high-mu triode. The diode section acts as the detector, and the triode section as the audio amplifier.

Since a detailed explanation of the operation of diode detectors has already been given under the topic TRF Receivers—Regenerative Detector, the operation of the diode detector which is shown in the accompanying circuit diagram will be described only briefly.

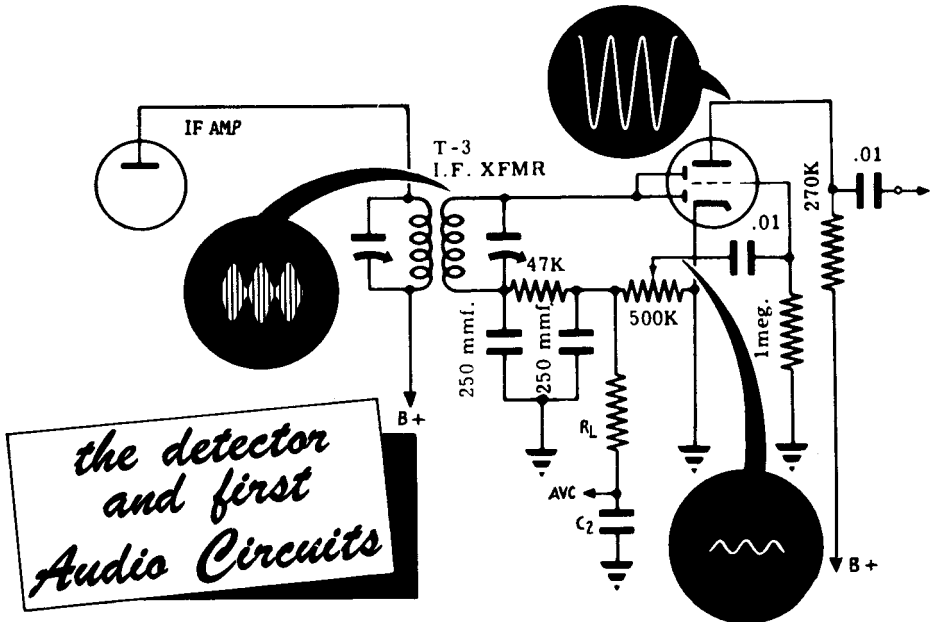

The diode acts as a rectifier and conducts current during that half of the signal cycle in which the plate is made positive with respect to the cathode. During the other half-cycle, when the plate is negative, no current flows. This produces a pulsating direct current which contains two components, one of which is audio frequency and the other intermediate frequency. The filter circuit, consisting of the 47K resistor and the two 250 mmf capacitors, filters out the IF component. The audio component of the pulsating direct current produces an AF voltage across the 47K fixed resistor and the 500K potentiometer. The AF voltage is applied to the grid of first audio amplifier and amplified at the plate as shown. Automatic volume control (AVC) which you will study later is developed across capacitor  $C_2$ .

# THE SUPERHETERODYNE RECEIVER

## How the Audio Amplifiers Work

The audio signal developed across the 500K potentiometer is taken off the sliding arm and applied to the grid of the first audio amplifier. The potentiometer is connected as a voltage divider and functions as a detector-output type of volume control. The triode acts as an audio amplifier which increases the voltage of the AF signal and passes it on to the last stage, which is known as the "second audio" or "final power amplifier" stage. The purpose of this stage is to amplify the signal output of the first AF stage until it is strong enough to operate a loudspeaker. Power output is the main consideration in this stage. The operation of the audio power amplifier has been discussed previously under TRF Receivers—Audio Amplifier Stage. It would be an excellent idea at this time to review the previous material dealing with audio power amplifiers before proceeding further.

## How Automatic Volume Control Works

Atmospheric conditions may sometimes cause fading of signals coming from certain stations. The resulting output of the receiver may at one moment be loud enough to blast the listener from his seat, while it may fade during the next moment to the point of becoming inaudible. Also, as you tune from one station to another, the signal strength may vary in the same way. One method of preventing this is to have the operator continually adjust the manual volume control in such a manner as to keep the output constant despite variations in signal strength. A better way of solving this problem is by the addition of a circuit which will accomplish this task automatically—an automatic volume control or AVC circuit.

The function of the AVC circuit is to vary the sensitivity or gain of the receiver in accordance with the strength of the signal. It reduces the sensitivity when a strong signal comes in and increases the sensitivity when the signal becomes weaker. The result is that the output of the receiver remains fairly constant in strength despite variations in signal strength.

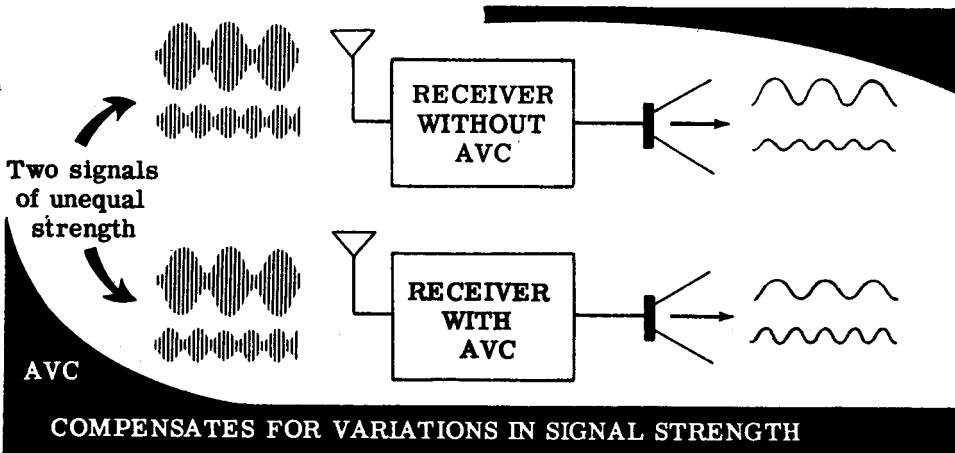

## THE SUPERHETERODYNE RECEIVER

### How Automatic Volume Control Works (continued)

The conventional AVC circuit most frequently encountered is incorporated in the diode detector stage. It requires that at least one, and preferably all, of the preceding IF amplifier, mixer or RF amplifier stages employ the variable- $\mu$  type of tube. It also requires some means of transferring the negative voltage that is developed by the AVC circuit to the control grid of these variable- $\mu$  tubes.

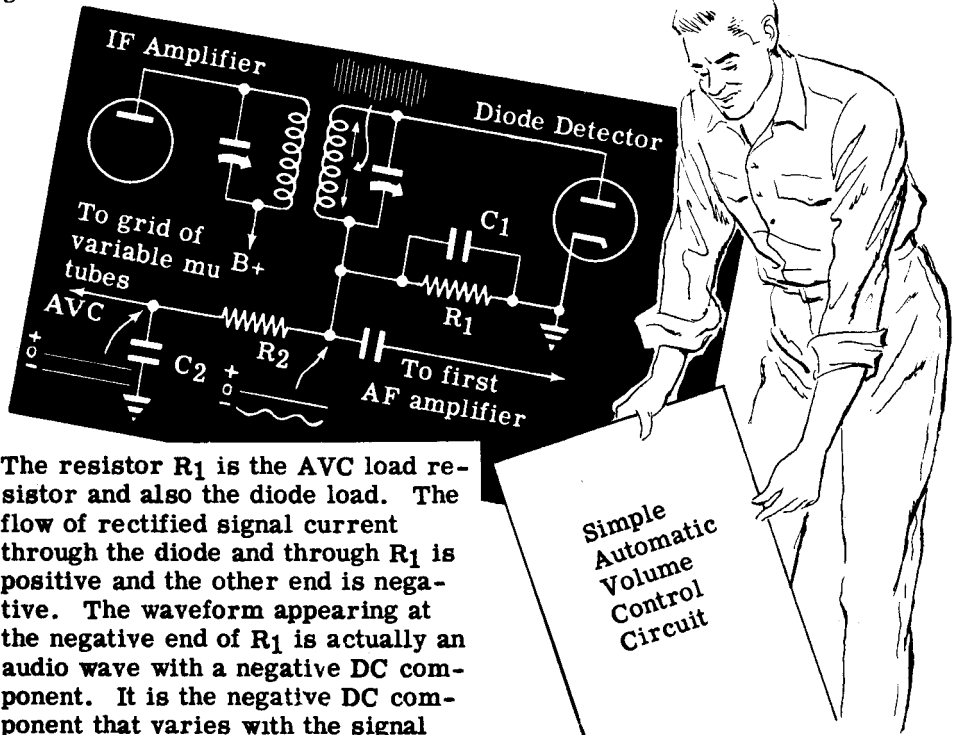

The resistor  $R_1$  is the AVC load resistor and also the diode load. The flow of rectified signal current through the diode and through  $R_1$  is positive and the other end is negative. The waveform appearing at the negative end of  $R_1$  is actually an audio wave with a negative DC component. It is the negative DC component that varies with the signal strength. The AVC filter circuit, consisting of  $R_2$ - $C_2$ , filters out the audio and  $C_2$  charges up to the negative DC component. It is this negative voltage that is applied through the AVC line to the grids of the variable- $\mu$  tubes in the preceding stages.

The amount of negative voltage developed will vary in accordance with two factors. One is the relatively rapid variation in strength and amplitude produced by the audio signal at the transmitter during the process of modulating the carrier wave. The second factor is the slower variation in negative AVC voltage produced by variations in signal strength due to atmospheric conditions. If the rapid variations produced by the audio modulating signals were allowed to travel down the AVC line to the preceding IF or RF stages, undesirable effects would be produced. The AVC filter circuit, consisting of  $R_2$  and  $C_2$ , is added to remove these audio frequency variations of the negative AVC voltage. The slower variations in signal strength which show up as a slowly varying negative DC voltage are not bypassed and pass down the AVC line to the grids of the preceding amplifier stages.

# THE SUPERHETERODYNE RECEIVER

## How Automatic Volume Control Works (continued)

Since these preceding IF and RF stages employ variable- $\mu$  tubes, the amount of gain produced in each stage is dependent upon the amount of bias present on the control grid. When the signal increases in strength, a high negative AVC voltage is developed between one end of  $R_1$  and ground. This negative voltage is applied through the AVC filter circuit and the AVC line to the control grids of the preceding stages, thus increasing the negative bias on these tubes. Because of this increased bias, there is a considerable decrease in the amount of amplification or voltage gain. In other words, the sensitivity of the receiver has been reduced. On the other hand, when a weak signal enters the receiver, a much smaller negative AVC voltage is developed. The bias on the amplifier tubes is reduced, resulting in considerably greater receiver sensitivity and voltage amplification for the weak signal. As far as the human ear is concerned, these variations in receiver sensitivity, as the signal strength varies, occur almost instantaneously, thus producing an output whose volume is reasonably constant.

## IF AMPLIFIER, DETECTOR AND FIRST AUDIO AMPLIFIER

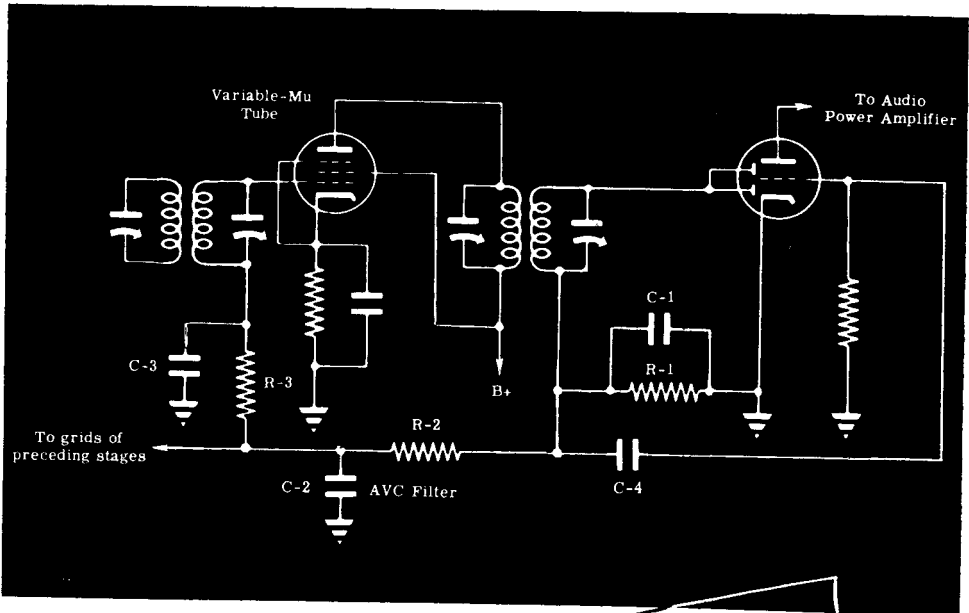

COMPLETE  
AVC  
CIRCUIT

# THE SUPERHETERODYNE RECEIVER

## How the Beat Frequency Oscillator Works

It will be recalled from the topic entitled TRF Receivers—Regenerative Detector that in order to receive CW signals on a regenerative detector, it was necessary to make the detector oscillate. The frequency of these oscillations differed slightly from that of the incoming signal, in order to produce an AF signal by the process of heterodyning.

In superhet receivers this is often accomplished by means of a separate BFO, or beat frequency oscillator, capacitively coupled to the diode detector. The BFO may be a Hartley oscillator tuned to a frequency 1 kc above that of the intermediate frequency. Thus, if the IF is 456 kc, the frequency of the BFO is 457 kc and a 1-kc audio signal will be produced in the diode detector. The frequency of the BFO is variable over a small range, making it possible to vary the pitch of the resulting beat note until a satisfactory tone is produced.

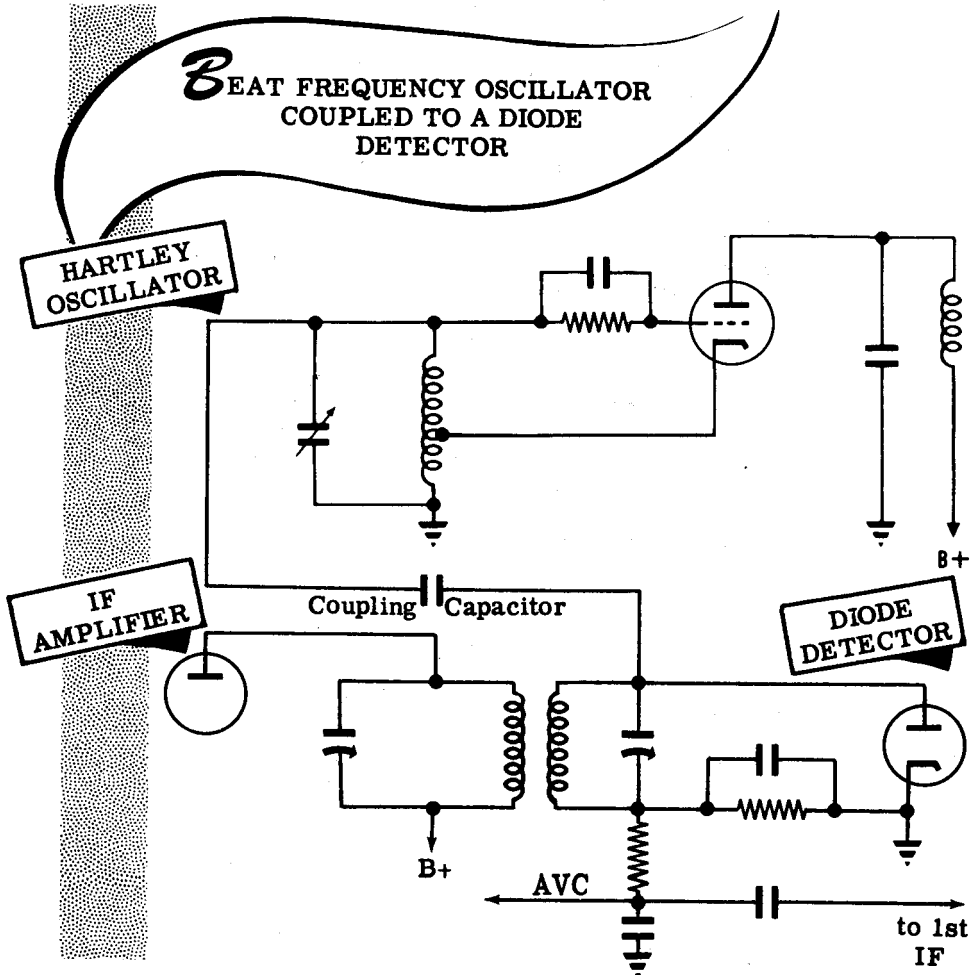

# THE SUPERHETERODYNE RECEIVER

## Complete Schematic of a Superheterodyne Receiver

The stages shown below include: a mixer, a local oscillator, one IF amplifier, a diode detector, an audio voltage amplifier, an audio power amplifier and a rectifier.

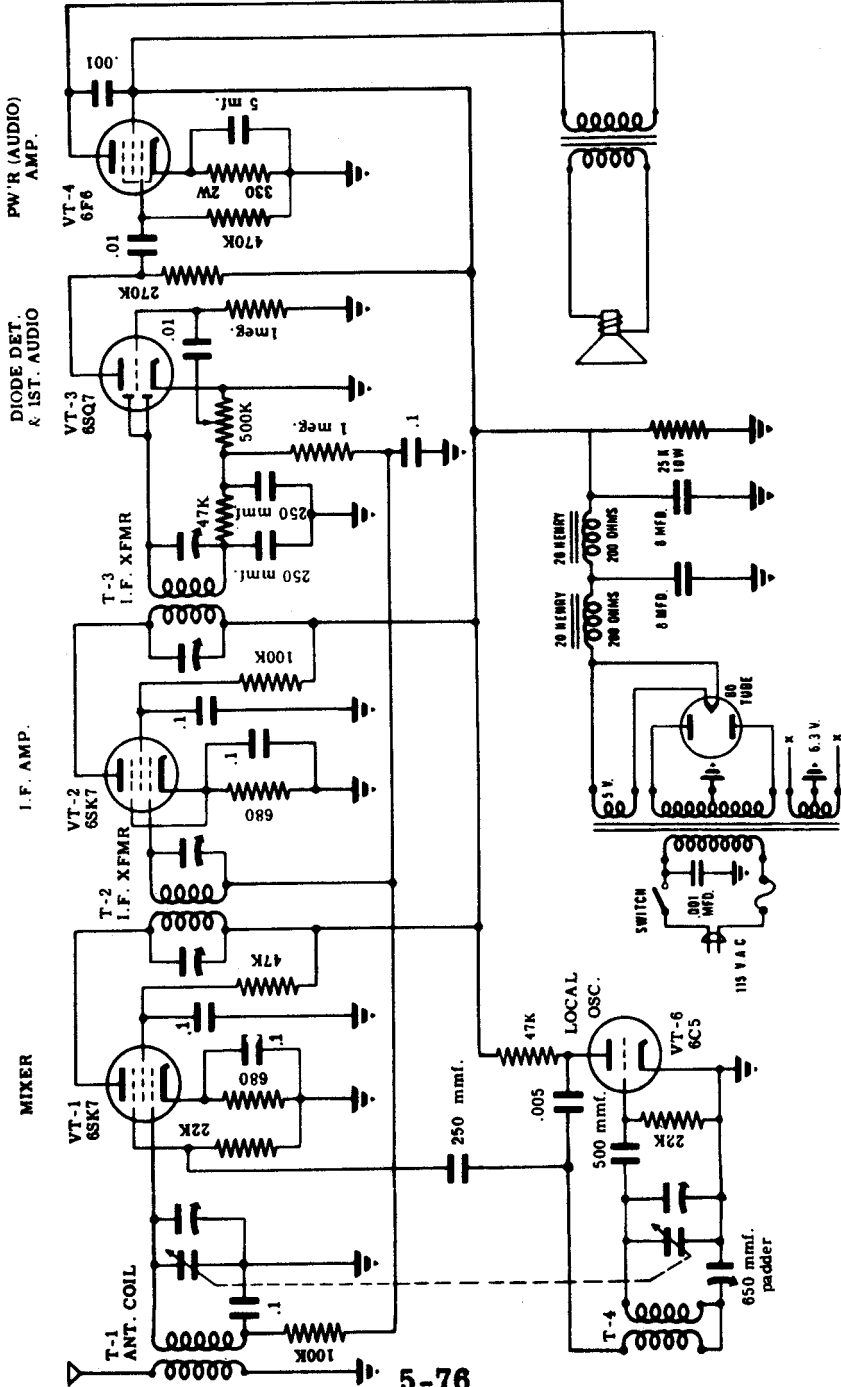

# THE SUPERHETERODYNE RECEIVER

## Analysis of the Local Oscillator Stage

### THE *Local Oscillator*

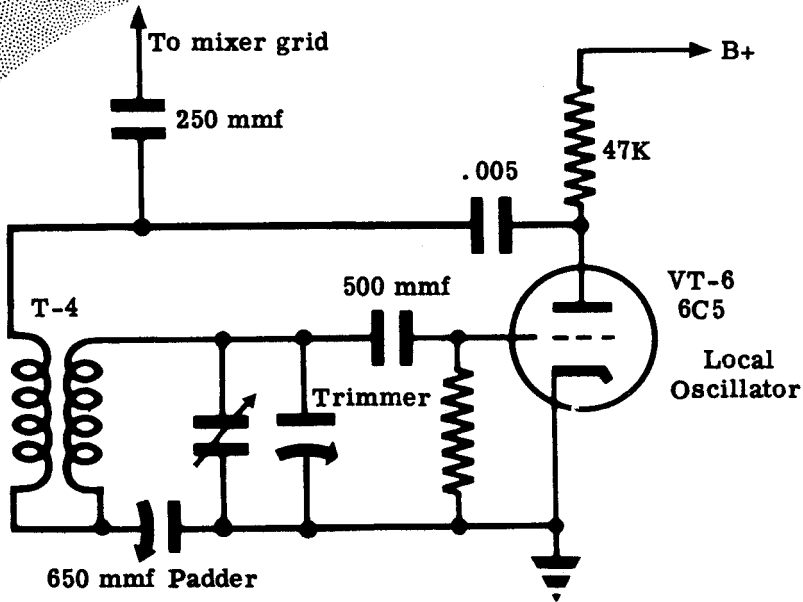

Now that you have seen the complete schematic of a superhet, it will be worth your while to spend a little time analyzing the function of the circuit components used in the oscillator, the mixer, and the detector stages.

The local oscillator circuit is basically that of an Armstrong (tickler coil) oscillator. Feedback is accomplished inductively using coil T-4. The variable tuning capacitor is ganged to the variable tuning capacitor of the mixer stage. The 650-mmf capacitor is a padder capacitor. It is used to make adjustments in the process of aligning the oscillator tuned circuit. It also serves to reduce the total capacity of the oscillator tank circuit so that the oscillator resonates at a frequency higher than that of the incoming signal.

The 500-mmf capacitor is a grid capacitor used to couple the tank circuit to the grid, while the 22K resistor is the grid-leak resistor. The 47K resistor is a plate load resistor which also blocks RF from going toward the power supply, and the .005-mfd capacitor couples the RF output of the plate circuit back to the tickler coil while effectively blocking the flow of direct current. Finally, the 250-mmf capacitor is used to couple the output of the oscillator with the suppressor grid of the mixer.

# THE SUPERHETERODYNE RECEIVER

## Analysis of the Mixer and IF Stages

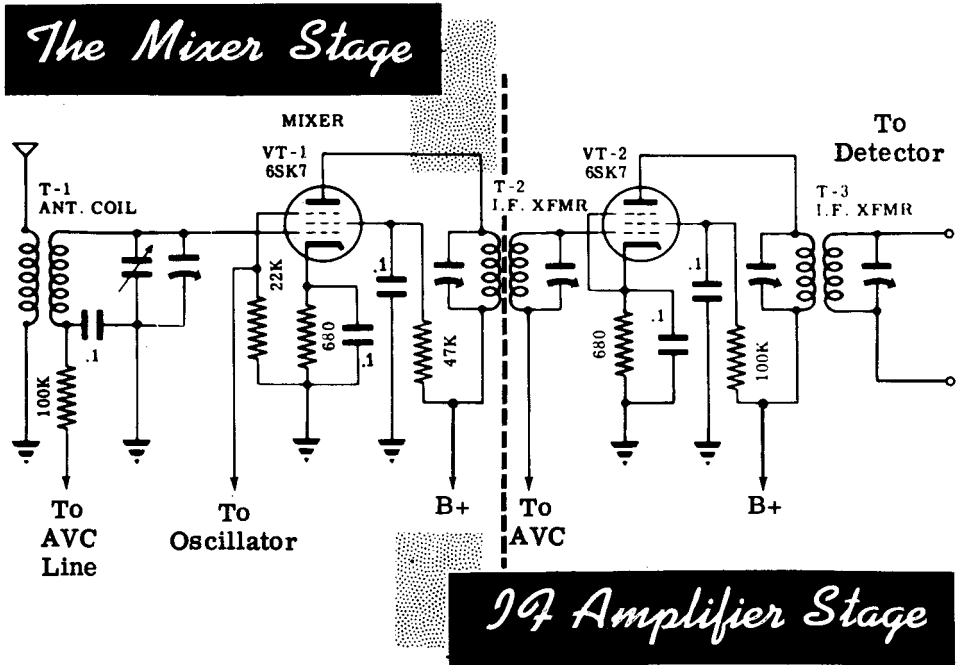

T-1 is the antenna coil used to couple the antenna with the control grid of the mixer. The variable tuning capacitor is used to tune the receiver to the desired station. It is ganged to the variable capacitor of the oscillator tank circuit. The signal from the oscillator is impressed upon the suppressor grid, and the 22K resistor is used to provide a path to ground for electrons that may collect on the suppressor grid. The 680-ohm resistor is a cathode bias resistor, while the 0.1-mfd capacitor in parallel with it is used to bypass the RF signal around the cathode bias resistor. The 100K resistor and 0.1-mfd capacitor connected to the bottom portion of the secondary winding of the antenna coil act as a decoupling network whose function is to keep the RF signal out of the AVC line. The 47K resistor and 0.1-mfd capacitor connected to the screen grid function as the screen grid voltage-dropping resistor and bypass capacitor respectively. T-2 is the input IF transformer which couples the 456 kc IF signal found in the plate circuit of the mixer with the grid circuit of the following IF amplifier.

The 680-ohm resistor and 0.1-mfd capacitor found in the cathode circuit of the IF amplifier serve as the cathode bias resistor and bypass capacitor respectively. The 100K resistor in the screen grid circuit is the screen grid voltage dropping resistor, while the 0.1-mfd capacitor in the screen circuit is the screen grid bypass capacitor. T-3 is the output IF transformer used in couple the IF amplifier with the diode detector. Both IF transformers are permanently tuned to the intermediate frequency—456 kc.



## THE SUPERHETERODYNE RECEIVER

### Analysis of the Diode Detector and First Audio Stages

# DIODE DETECTOR AND FIRST AUDIO AMPLIFIER

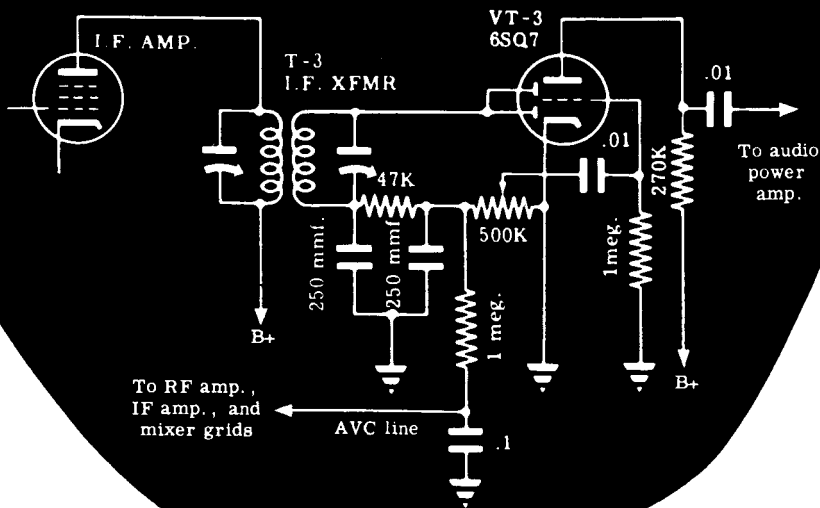

The two 250-mmf capacitors function as the detector filter capacitors. Their purpose is to bypass the IF component of the signal to ground around the 47K and 500K diode load resistors. The 47K resistor is part of the filter network, while the 500K potentiometer also acts as a bleeder resistor across the filter. It controls the amount of detector output delivered through the .01-mfd coupling capacitor to the grid of the first audio amplifier and thus serves as a volume control.

The 1-meg. resistor and 0.1-mfd capacitor in the AVC line filter out the relatively rapid variations in AVC voltage produced by the audio component of the signal. They allow the slower variations in AVC voltage produced by variations in signal strength to pass unimpeded down the AVC line.

The 1-meg. resistor connected to the control grid serves as a path to ground for any electrons that may accumulate on the grid. The 270K resistor acts as the plate load of the first audio stage, while the .01-mfd capacitor in the plate circuit couples the output of the first audio amplifier to the grid of the audio power amplifier.

The circuit of the audio power amplifier does not require further analysis, since the circuit is the same as that of the power amplifier previously discussed under the topic entitled TRF Receivers—Audio Amplifier Stage.

# THE SUPERHETERODYNE RECEIVER

## What Alignment Is

The superheterodyne receiver must be adjusted almost as carefully as a jeweler adjusts a watch. This process, called "alignment," is the same for all superheterodyne receivers. You align your superhet to make it operate at its best output. The purpose of alignment is to get the maximum gain in the superhet receiver for any setting of the main tuning dial. When the dial is set to receive a station transmitting at 980 kc, you want the receiver to give the greatest gain at 980 kc. The same thing must be true for every setting on the dial. The tuned circuits—RF, local oscillator, and IF—must be adjusted to give always the maximum output. How does the superhet circuit have to be tuned to give the greatest gain for each dial setting?

1. The IF transformers must be tuned to the fixed IF frequency.
2. The RF tuned circuit must be tuned to the frequency on the dial.
3. The local oscillator must be tuned to give an output at each setting of the main dial that is above or below the dial setting or RF frequency by a difference equal to the IF frequency.

A review of the superheterodyne circuit will show you how the tuning is done in the circuit itself. The diagram below includes all the tuned circuits in the receiver. The tuned circuits in the IF transformers are fixed to give maximum gain at the IF frequency. The RF circuit in the mixer grid is gang-tuned with the local oscillator. The trimmers on the two-gang variable capacitor and the padder capacitor in the local oscillator tank circuit are adjusted to keep the frequency difference between the RF circuit and the local oscillator constant at the IF frequency. For any setting of the dial, the local oscillator output must be above (or, in some sets, below) the received RF signal by the fixed difference of the IF frequency.

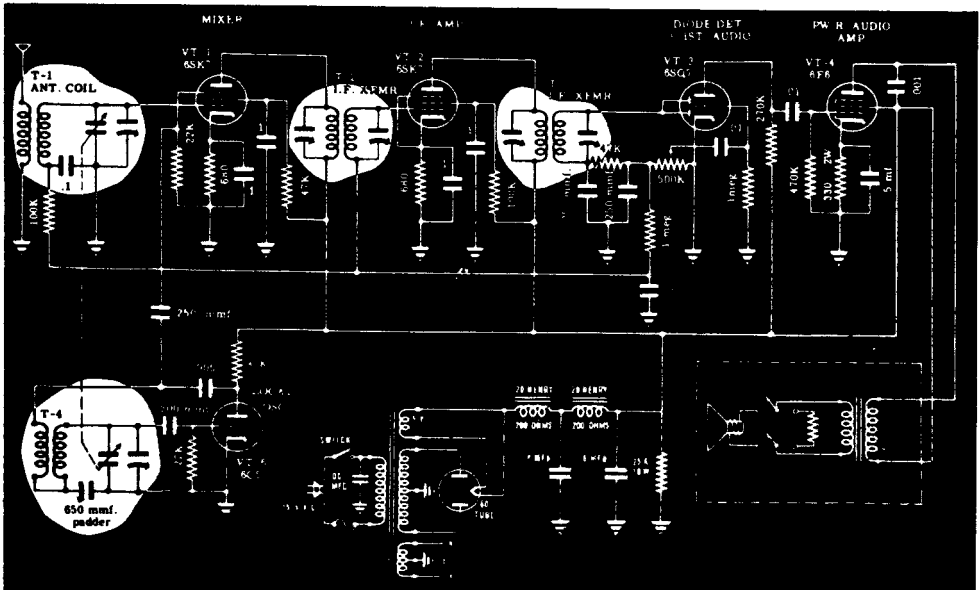

# THE SUPERHETERODYNE RECEIVER

## The Alignment Procedure

There are only three steps to follow to get the RF and the local oscillator tuned circuits adjusted in such a way that at any dial setting, there will be the best "tracking" possible. Perfect tracking would mean that as the RF tuning is varied, the local oscillator tuning will vary so as to maintain a fixed frequency difference.

**PERFECT  
TRACKING**

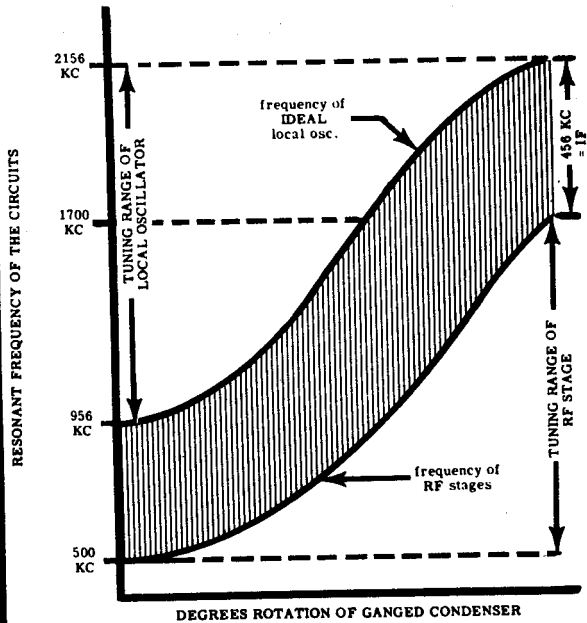

The first step is to adjust the trimmers on the two-ganged variable capacitor. Since these trimmers are in parallel with the tuning capacitors, they affect the total capacitance more at the high frequency end of the band (when the variable capacitor has minimum capacitance) than at the low frequency end. For this reason, the trimmers will be adjusted at 1500 kc, which is close to the high end of the broadcast band.

The local oscillator padder is in series with the tuning capacitor and will have more effect on the total capacitance when the tuning capacitor has maximum capacitance. This occurs at the low end of the tuning range where the plates of the variable capacitor are fully meshed. The padder will be adjusted at 600 kc, the low end of the band.

There is a problem here. When the 600-kc signal is fed into the input, even if the RF circuit is not set exactly to 600 kc, it is possible to adjust the local oscillator's padder for a maximum output; but this is not the best setting of the padder although the local oscillator frequency is 1056 kc. The real maximum will occur when the local oscillator is adjusted to 456 kc above 600 kc at the same setting that the RF circuit is tuned to 600 kc. The correct adjustment is achieved by a process called "rocking in." In rocking in, you make adjustments of the padder at several settings of the tuning dial in the vicinity of 600 kc. The setting at which the maximum output is greatest is the correct one. The local oscillator padder has been adjusted so that the local oscillator frequency differs from the resonant frequency of the RF circuit by 456 kc.

After the padder has been properly adjusted, you will tune back to 1500 kc, inject a signal of 1500 kc, and readjust the trimmer capacitors at the high end of band.

# THE SUPERHETERODYNE RECEIVER

## What Sensitivity Measurements Are

Sensitivity measurements are used to determine how sensitive a receiver is. A receiver may be operating normally, as far as your ear or even an oscilloscope can detect, but, if the overall gain of the set is low, you may not be able to receive weak signals. This would only show up by measuring the overall gain of your receiver and comparing the results with the overall gain of a standard receiver.

If a receiver was tested and found to have low sensitivity, the cause would then have to be determined. This would be done by checking the gain of each stage and comparing the results with some standard, thereby determining which stage has the low sensitivity. This trouble is almost always due to a weak tube in the stage which has low sensitivity.

Consider a typical broadcast-band receiver. Broadcast receivers are not designed to be very sensitive since very powerful stations are relatively close to the receivers. In these receivers, a loss of sensitivity would mean you would turn up the volume control and nothing more. Therefore, sensitivity measurements are not necessary. Only when reception becomes so poor that it is uncomfortable or impossible to hear a station, would you attempt to repair the receiver.

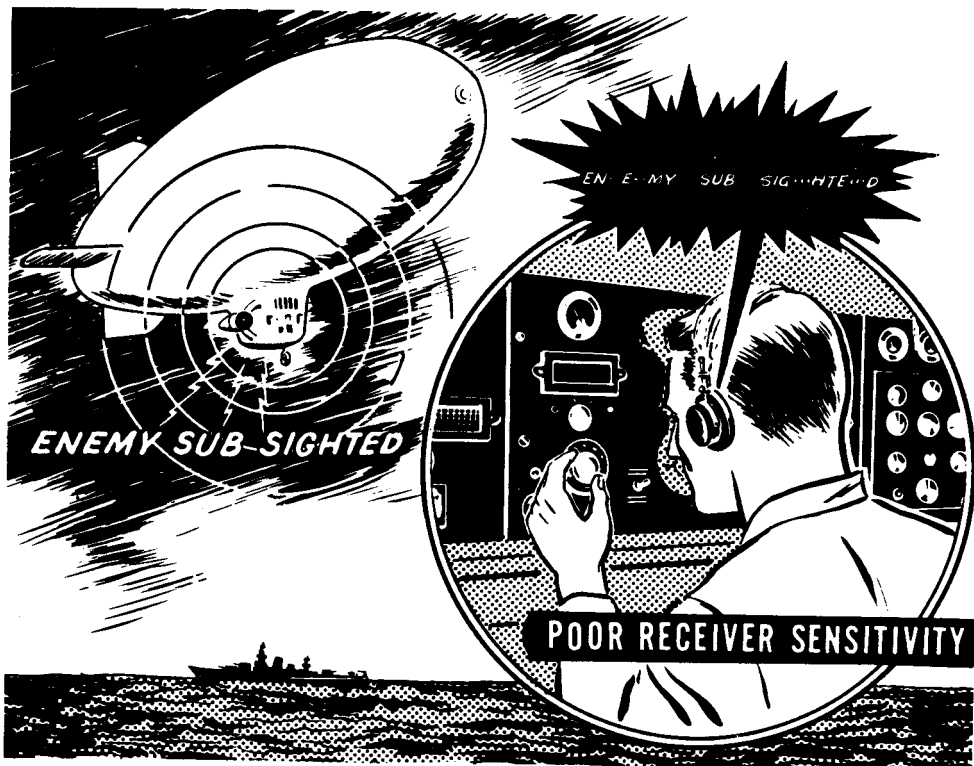

# THE SUPERHETERODYNE RECEIVER

## The Importance of Sensitivity Measurements

In some receivers, sensitivity measurements are very important. In a radar or sonar receiver, lack of sensitivity would mean that distant targets which should be detected would not be noticed at all. Decreased gain in a communication receiver would mean that weak signals could not be heard. If any of these devices have low sensitivity, you could not discover this fact by operating them, since you usually have no way of obtaining all the necessary data. You can't tell that a distant target is present unless you pick it up; you can't tell that a weak, distant transmitter is calling you unless you hear the message. Your only check on the performance of the receiver is through sensitivity checks.

Here is the typical way sensitivity measurements would be made with receiving equipment. An output meter is used to measure the output of the last stage of the receiver. The instruction book for the piece of equipment will tell how many microvolts are required as the input to this receiver for a standard output as measured on the output meter. Using a signal generator which has a calibrated output, you inject a signal of the proper frequency into the receiver input. You adjust the signal generator output until you read the standard amount of output on the output meter. By comparing the input you needed with the instruction book's data, you can tell if the receiver is working up to par. If the input you used is larger than that stated in the instruction book, your receiver has too low a sensitivity. You would then take stage-by-stage sensitivity measurements to determine the weak stage.

Starting with the last stage of the receiver, you inject a signal of proper frequency and adjust the signal generator output until the standard receiver output is obtained. If the input you used compares well with the instruction book data, the last stage of the receiver is working properly. You repeat this procedure for each stage, working backwards from the last stage. The stage that requires a larger input than that specified in the instruction book is the stage with low gain.

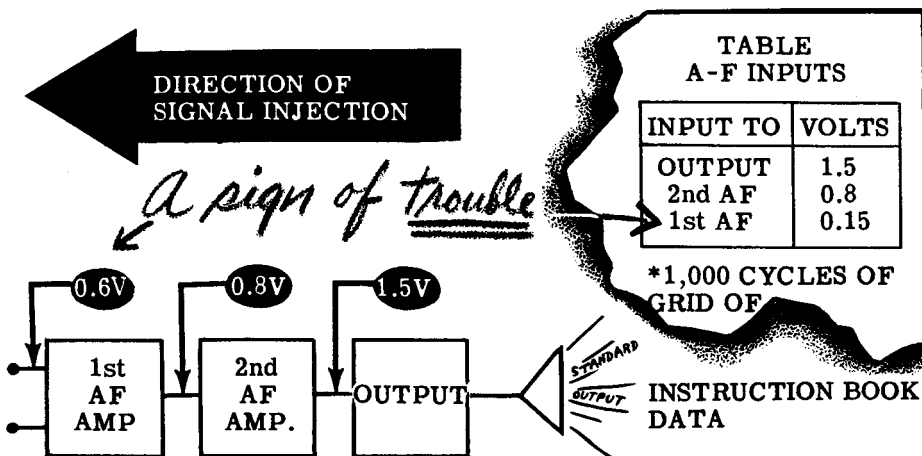

## THE SUPERHETERODYNE RECEIVER

### Demonstration—Aligning the IF Section

The first part of the receiver to be aligned is the IF section. The instructor removes the oscillator tube to prevent any signal other than that of the signal generator from entering the IF strip. He also shorts the AVC signal to ground since the AVC circuit, if operative, would tend to broaden the receiver response and thus make it more difficult to align the receiver sharply. The 'scope or output meter leads are connected across the speaker and the signal generator test leads are ready to be applied to the various test points in the IF section.

With the receiver gain at maximum, a modulated 456 kc signal is injected into point 1, the grid of the IF amplifier. Using an alignment tool, the instructor adjusts the trimmers on the IF output transformer for a maximum output on the 'scope screen. As the 'scope signal increases with the adjustment, the RF control knobs are lowered.

Next the RF signal is injected into point 2, the grid of the mixer stage, and the trimmers of the IF input transformer are adjusted for a maximum indication on the 'scope.

The trimmers on both the IF transformers are again touched up slightly to obtain optimum alignment of the IF section.

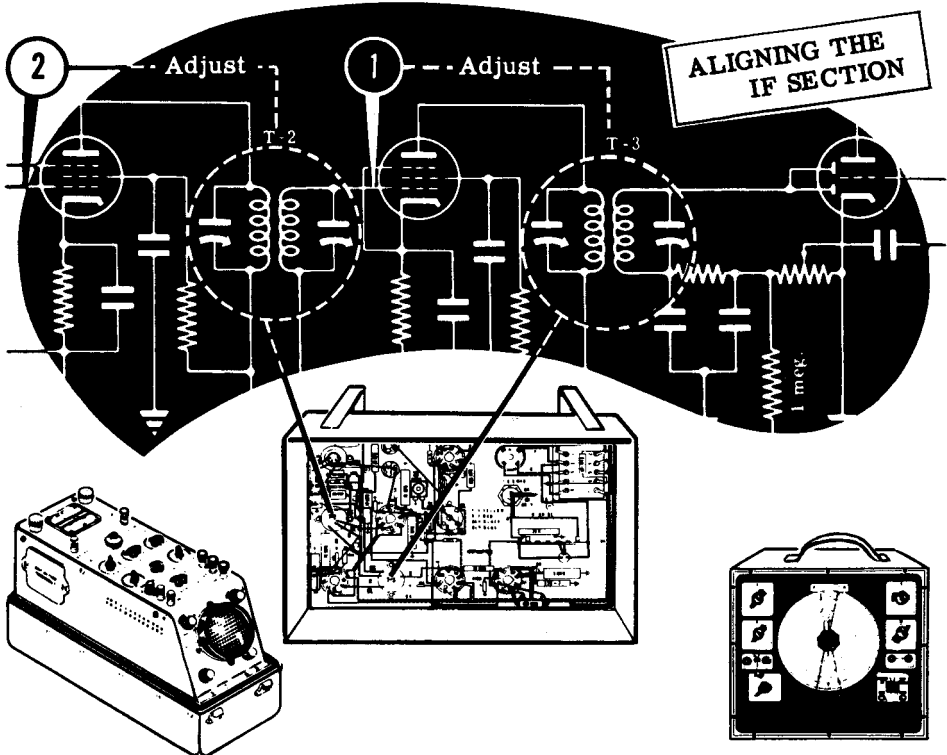

# THE SUPERHETERODYNE RECEIVER

## Demonstration—Aligning the Mixer and Oscillator

With the IF strip aligned, the RF tuned circuits in the grid of the mixer and the local oscillator are aligned next.

The instructor replaces the oscillator tube but leaves the AVC circuit shorted to ground. The signal generator test probe is moved to the antenna terminal and the signal generator is set to give a modulated RF output of 1500 kc. The receiver dial is set approximately to 1500 kc, and a signal is observed on the 'scope. With the alignment tool the instructor adjusts the oscillator and RF trimmers to give a maximum output on the 'scope screen. Now the RF circuit is tuned to resonate 1500 kc, and the oscillator is tuned to oscillate at 1556 kc.

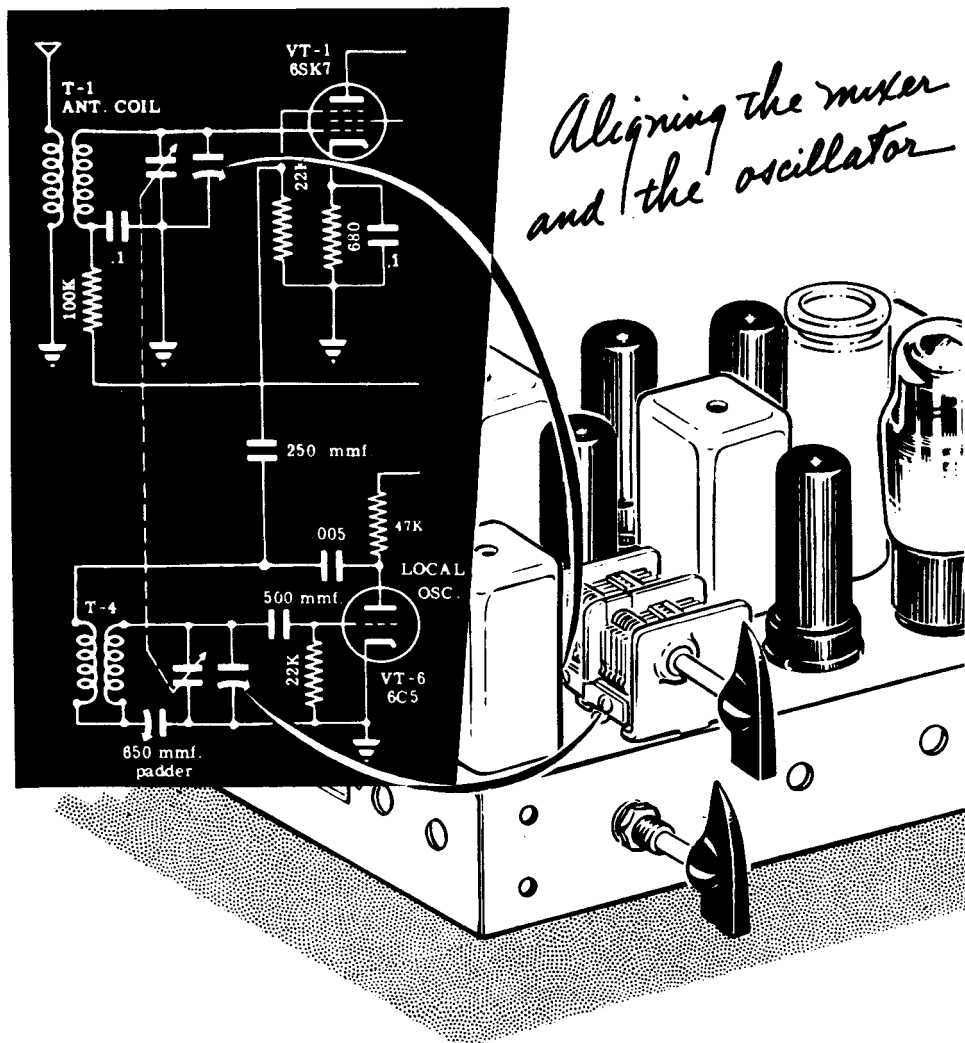

## THE SUPERHETERODYNE RECEIVER

### Demonstration—Aligning the Mixer and Oscillator (continued)

The mixer and oscillator tuned circuits must now be aligned at the low end of the band.

The instructor sets the signal generator at 600 kc and the receiver dial at 600 kc. He then adjusts the oscillator padder capacitor to give a maximum output on the 'scope. Now the oscillator is adjusted to oscillate 456 kc above the incoming signal of 600 kc.

Although the dial is set at 600 kc, there is no assurance that the RF tuned circuit is resonant to 600 kc. The ideal alignment for maximum output is to have the RF tuned circuit exactly resonant to 600 kc with the oscillator tuned to 456 kc above 600 kc. The ideal alignment is obtained by a procedure called "rocking in."

First the instructor notes the size of the 'scope image, and then he tunes the receiver in one direction slightly away from receiver dial reading of 600 kc. He readjusts the padder for a maximum output on the 'scope. If the 'scope image is greater than it was before, he has changed the setting of the tuning dial in the right direction. If the output is less, he must tune the receiver in the opposite direction from the 600 kc dial reading. Having found the right direction, he keeps on varying the setting of the tuning dial and adjusting the padder until an absolute maximum 'scope image is reached. At this point the RF circuit is tuned exactly to 600 kc with the local oscillator tuned to 1056 kc. Making sure not to change the setting of the tuning capacitor, the instructor loosens the knob set screw and repositions the knob so that the pointer now reads 600 kc. The final step in alignment is to touch up the alignment at the high end of the band.

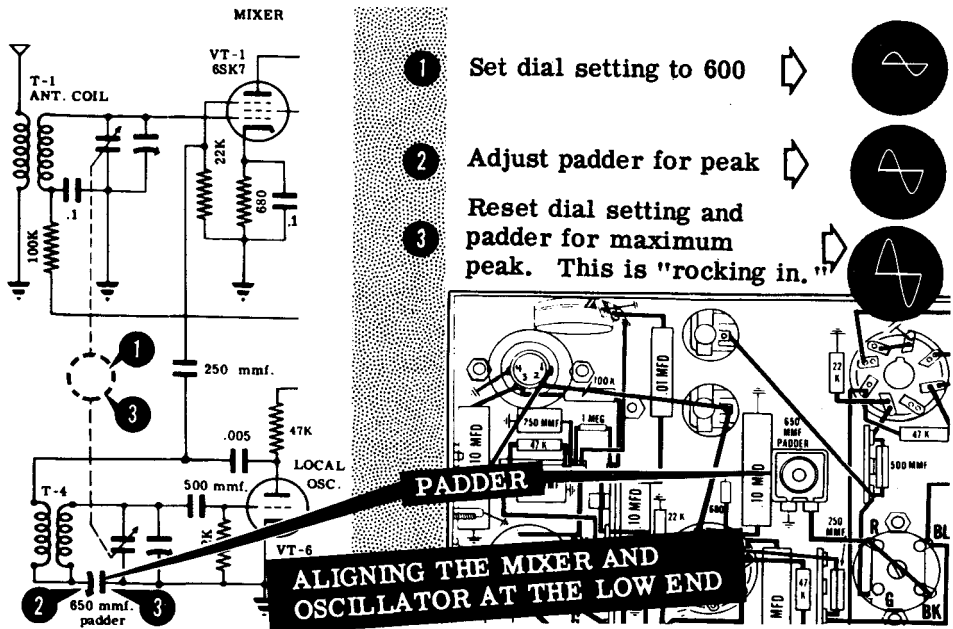



# THE SUPERHETERODYNE RECEIVER

## Review of the Superhet Receiver

**SUPERHETERODYNE**—A type of receiver in which the RF signal is converted to a lower frequency RF and then amplified before detection. It has much higher sensitivity, selectivity and stability than the TRF.

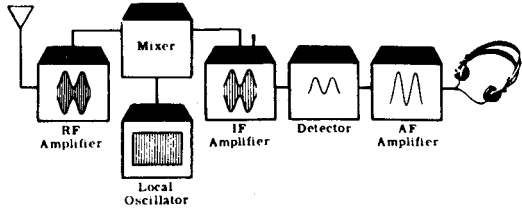

**MIXER**—This is the key circuit in a superhet. It takes the RF signal and beats it against the signal generated by a local oscillator. The resultant constant frequency signal is lower in frequency than the RF and thus is easier to amplify.

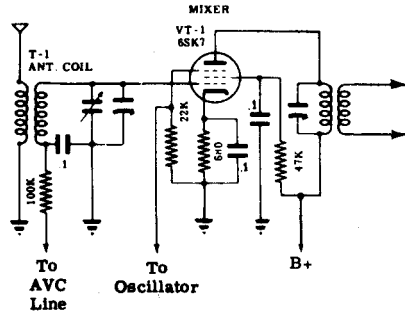

## LOCAL OSCILLATOR

This circuit is tuned simultaneously with the RF tuned circuits in such a way that its output frequency is always 456 kc greater or less than the frequency of the signal being received. Its output is combined with the RF signal in the mixer, which thus always feeds a constant frequency signal to the IF amplifier.

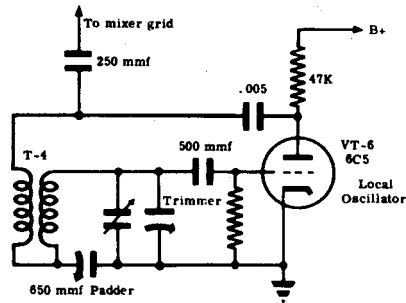

**IF AMPLIFIER**—The section of the superhet which amplifies the fixed frequency signal coming from the mixer. Its input and output are usually coupled by transformers in which the primary and secondary are tuned. This results in high selectivity.

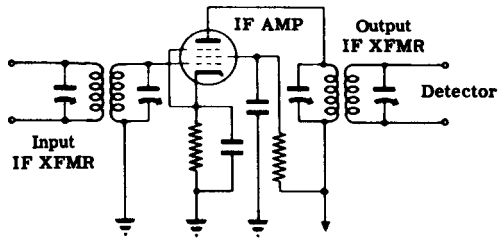

**DETECTOR AND AF AMPLIFIER**—These circuits perform the same functions as in the TRF receivers. In the superhet the diode detector is often combined with the first AF amplifier stage.

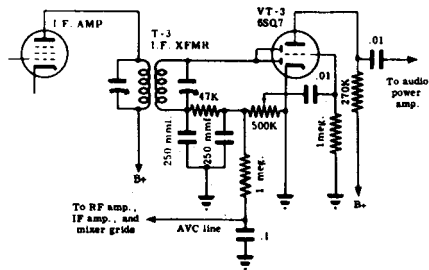

# THE SUPERHETERODYNE RECEIVER

Review of the Superhet Receiver (continued)

## AUTOMATIC VOLUME CONTROL (AVC)

—This circuit compensates for variations in signal strength. A diode rectifies the negative half of the signal and feeds the DC output to the RF and IF amplifier grids. When the signal increases the diode output increases, thus putting more negative bias on the RF and IF amplifiers and lowering their gain.

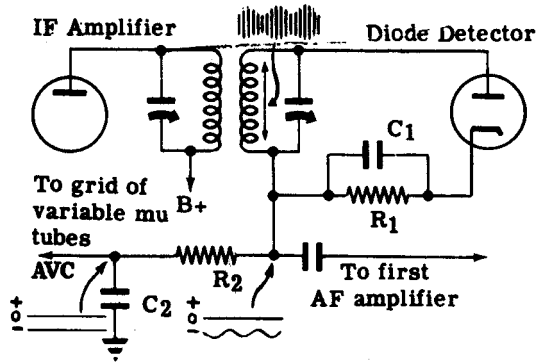

**TRACKING**—When the difference between the local oscillator frequency and the RF signal frequency is constant over the entire tuning range of the superhet, it is said to have perfect tracking. This is never achieved in practice.

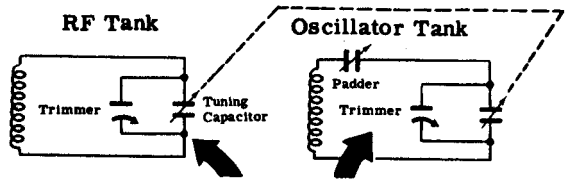

**TRACKING:** 456 kc difference over entire tuning range

## BEAT FREQUENCY OSCILLATOR (BFO)

—This is an oscillator used when it is desired to receive CW signals with the superhet. Its output is tuned close to the frequency of the IF and is fed into the detector. It beats with the incoming signal, producing a beat note in the audio range. With a BFO, a CW signal is heard as a pure tone. Without a BFO, CW signals are heard as a soft hiss or not at all.

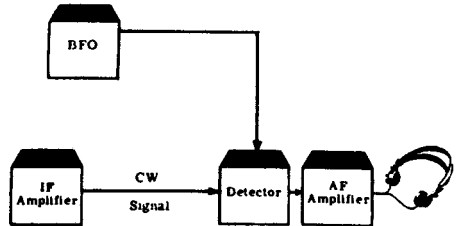

**IMAGE FREQUENCIES**—If the IF is 456 kc, then two signals (one 456 kc above and the other 456 kc below the oscillator frequency) will both send a signal through the IF amplifier and to the loudspeaker. One of them is the desired signal; the other is an image. The purpose of a tuned antenna coil and tuned RF amplifiers is to eliminate the image frequency.

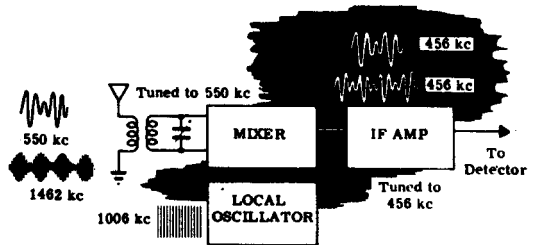

# TROUBLESHOOTING THE SUPERHETERODYNE RECEIVER

## Review of the Troubleshooting Method

If you have to fix a defective piece of equipment, here is one way that you might go about finding the trouble source. If there is a complaint tag attached to a piece of equipment, get as much information as you can from it, so that you don't waste time looking for troubles that aren't there. In the event that there is no complaint tag, follow the procedure described in the following paragraphs.

### Inspect the Equipment

This is a very important step—many defects can be found by using your five senses. Once you have heard a transformer sizzle and smelled the smoke, you will be able to spot a burned-out power transformer without even turning the chassis over. Visual inspection does not take long—in about two minutes you should be able to see the trouble if it is the kind that can be seen.

You should fully realize the significance of visible defects and you should know just how they can be recognized. Remember that even though you do find and repair a defect, you must prove to yourself that the equipment is operating properly and that there are no other defects. Usually, there will be only one trouble in a piece of equipment unless the faulty component has been caused to burn out by some other fault. When you find a trouble by visual inspection, try to imagine another trouble which could have caused the one you've located. If you merely proceed to replace the faulty component and then turn the equipment on, the replacement part may burn out again. The most obvious example is a fuse which burns out, gets replaced, and then the second one burns out. You must locate the cause of the trouble before you replace the faulty parts.



# TROUBLESHOOTING THE SUPERHETERODYNE RECEIVER

## Troubleshooting by Signal Tracing and Signal Injection

Devices such as radar, sonar and radio receivers are very complex. If you attempted to do troubleshooting on a radar receiver by means of voltage and resistance checks alone, you would have a long tiresome task ahead of you. There would be hundreds of voltage, current and resistance checks for you to perform, not to mention tubes and tuned circuits to be tested. And then there would always be the possibility that none of your checks would show you what was wrong, since static testing will not show up faults like misaligned tuned circuits, certain tube defects or defective automatic control circuits.

Fortunately, the signal injection method is an ideal way to locate quickly any receiver trouble.

Suppose you review the advantages of troubleshooting by signal tracing.

1. You can test each section of the receiver by putting in a signal and listening to the signal at the output or by examining the output with an oscilloscope.
2. You can determine immediately the defective section, since the signal at its output is either missing or distorted.
3. Knowing the section with the trouble, you can isolate the trouble to a particular stage by injecting a signal of the proper frequency and amplitude into the grid points, starting at the output and working back towards the input. The point at which the signal disappears or becomes distorted is the place to look for trouble.
4. Once the defective stage has been found the defective component can be isolated by using voltage and resistance checks.

Signal tracing and signal injection, therefore, enable you to find the trouble quickly and easily by greatly reducing the number of points to be tested. By the use of signal tracing, you can locate the stage which contains the trouble and sometimes, depending on the nature of the trouble, the faulty part. You also can narrow the trouble down to the particular stage or component with a minimum number of checks of those stages which are functioning properly.

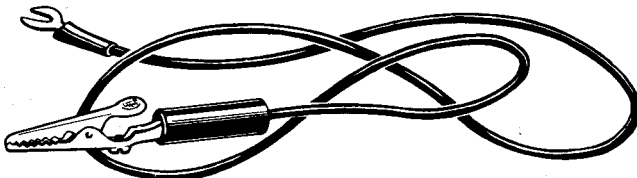

## TROUBLESHOOTING THE SUPERHETERODYNE RECEIVER

### Troubleshooting by Signal Tracing

The best way to locate the trouble is to trace a signal through the equipment, using either signal tracing or signal injection. Signal tracing and signal injection are basically the same thing. Each has some advantages over the other for the testing of different types of basic circuits. The basic purpose of these signal tracing methods is to locate the exact area of a trouble. Any break or short in the signal path can be located immediately because the signal will disappear at that point. If the trouble is due to an improper voltage on a tube or is due to a faulty tube, the signal will not pass (or will be distorted) between the grid and plate circuit of the tube. If the trouble is of this nature, it can be localized immediately to the specific tube, and then the exact trouble can be located by voltage and resistance checks and by trying a tube known to be good. Let's review the procedure for signal tracing and signal injection.

In the procedure for signal tracing, the normal signal input for a piece of equipment is connected to the input terminals. The 'scope is then used to trace the signal from the input towards the output. The point at which the signal disappears or becomes distorted is the point to look for the trouble.

Signal tracing can be used with practically every type of circuit that you will come across. In general, it is most useful in equipment where there is an audio signal. It may be used also in equipment where there is an RF signal of voltage amplitude high enough to be seen on the 'scope. Signals cannot be traced easily in receivers because of the low voltage RF signals present in a major part of the circuit.

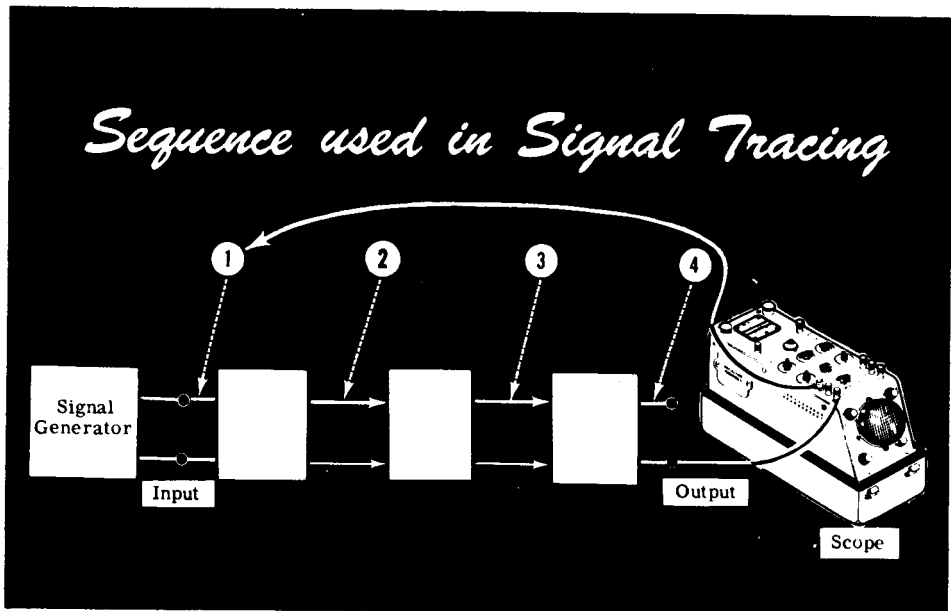

## TROUBLESHOOTING THE SUPERHETERODYNE RECEIVER

### Troubleshooting by Signal Injection

In the procedure for signal injection, the 'scope is permanently connected to the output of a piece of equipment. The signal generator is used to inject a signal of the proper amplitude and frequency into the various test points, starting at the output and working towards the input. Signal injection has the disadvantage of seeming to be a "backwards" procedure; actually it is basically the same as signal tracing.

Signal injection is used mainly with receivers and other similar equipment where there are high frequency amplifiers with a very low input voltage. The 'scope amplifier cannot amplify signals of radio frequency and the signal amplitude is much too low to be seen if it were connected directly to the 'scope vertical deflection plates. Signal injection solves this problem by using a signal generator to inject signals into various parts of the equipment. The amplifiers in the equipment under test will give a large enough gain so that the signal can be seen on the 'scope screen. The first stage to check is the last stage of the piece of equipment. If this last stage is operating normally, the next to the last stage is checked by feeding a signal into that stage and checking the output at the same point as before. It is because the 'scope is always observing the output of the equipment in signal injection that the last stage in the equipment is the first one to be checked. Just as in signal tracing, the point where the signal becomes distorted or disappears is the point to look for the trouble. For example, if the last stage is checked O. K. but when the signal is placed on the input to the next to the last stage, the output is not normal, the trouble is in the next to the last stage.

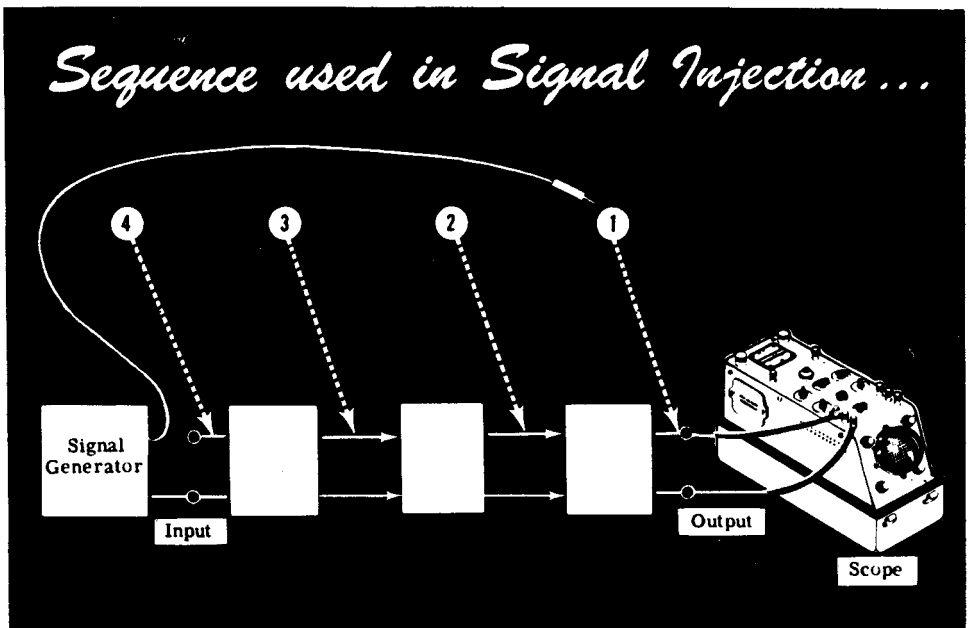

# TROUBLESHOOTING THE SUPERHETERODYNE RECEIVER

## Troubleshooting the Superheterodyne Circuits

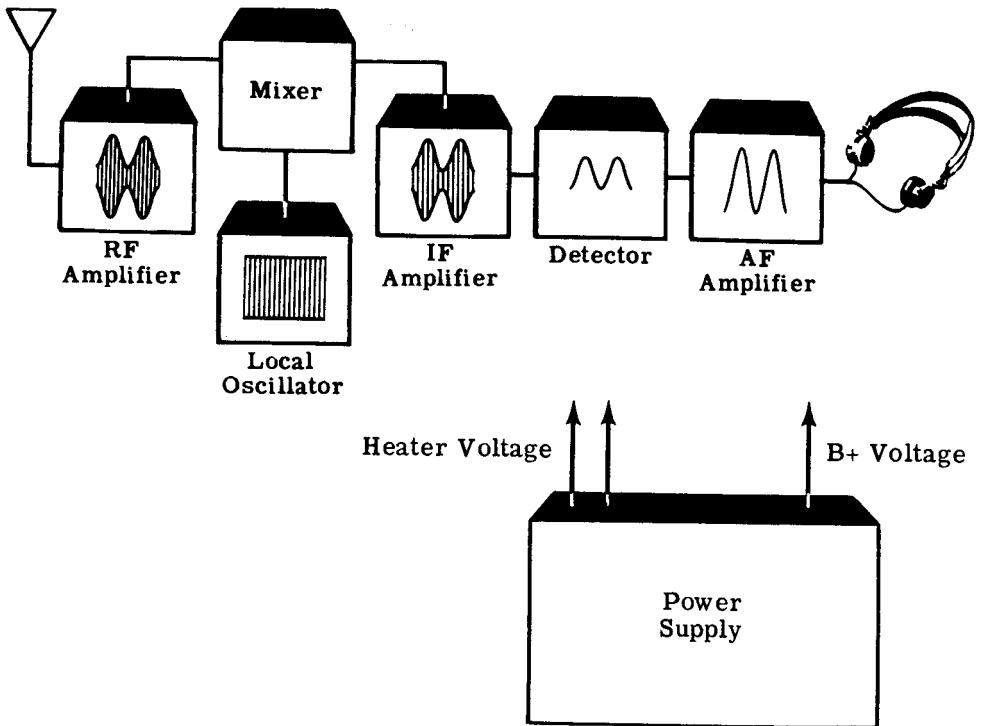

Here is an outline of how to troubleshoot the various sections of a superhet receiver.

### 1. The Power Supply

The power supply furnishes B+ and heater voltage to the various components of the receiver. In troubleshooting a power supply, the AC signal from the line cord is traced through the transformer, the rectifier tube, the filter circuit and up to the power supply bleeder resistor. The final B+ voltage should be quite free of hum, even with the 'scope Y GAIN control turned all the way up.

### 2. The Audio Amplifier

In troubleshooting the audio amplifier in a receiver, use the signal injection method because you will have to use that method for the rest of the receiver. The 'scope should be connected across the loudspeaker at the output transformer secondary. An audio signal should be injected into the various test points from the 'speaker towards the detector. The point at which the signal disappears or becomes distorted is the point to look for the trouble with your voltmeter and ohmmeter.

Use the 400-cycle audio output of the signal generator. Remember to use a .01-mfd blocking capacitor at the end of the probe to keep B+ out of the signal generator.

### Troubleshooting the Superheterodyne Circuits (continued)

#### 3. The Detector

The operation of the diode detector has been described in this section and the operation of two other basic types of detectors will be found in the TRF section. The detector takes a modulated RF (or IF) signal and separates the audio from the RF component. The high frequency component is bypassed to ground and the audio signal is connected to the audio amplifier. In troubleshooting a detector, a modulated RF (or IF) signal is injected into the detector input. If an audio signal corresponding to the modulation does not appear on the 'scope screen, there is trouble in the detector. Don't forget to use a 200-mmf isolating capacitor at the end of the test probe.

#### 4. The IF Amplifier

The IF amplifier is an RF amplifier operating at a fixed frequency of 456 kc. The operation of the IF amplifier is similar to that of the RF amplifier described in the amplifier section—the only difference being that the IF amplifier operates at a fixed frequency and, because of this, may be designed for a much higher gain. By injecting a modulated 456-kc signal, you can first test the output transformer, then the tube and finally the input transformer. In all cases an audio signal should appear on the 'scope. This method will localize the trouble in any one of these three circuits—the rest is a job for the voltmeter and ohmmeter.

#### 5. The Mixer and the Oscillator

The mixer stage selects the desired modulated RF signal from the antenna and mixes it with the unmodulated signal from the local oscillator. The local oscillator and the mixer tuning circuit have mechanically-ganged tuning capacitors which keep the frequencies of the selected signal and the oscillator 456 kc apart. As a result of the mixer tube action, a modulated 456-kc signal is fed into the IF amplifier no matter what the frequency of the incoming RF signal. Information on the operation of oscillator circuits will be found in the oscillator section.

The mixer is tested by first injecting a modulated 456-kc signal into the grid. If this signal passes through the mixer and appears as an audio signal at the final output, the mixer stage is operating. Then an RF signal is injected into the antenna input and tuned in by means of the antenna tuning circuit—an audio signal should appear on the 'scope. If no signal appears, there is trouble in the antenna tuning circuit or the oscillator circuit.



# TROUBLESHOOTING THE SUPERHETERODYNE RECEIVER

## Vacuum Tube Testing

Contrary to the belief commonly held by the general public, the first step in troubleshooting is not the testing of tubes. It is necessary to isolate the defective stage and to check that stage to reveal the defective component. However, since many receiver defects are due to faulty tubes, it is important that you become familiar with the operation of tube testing equipment.

Since burned-out filaments cause the majority of tube failures, it is usually possible to discover such defective tubes by removing them from the receiver and testing with an ohmmeter. A noisy tube, called a "microphonic tube," may be discovered by turning the receiver power on and then tapping each tube gently. If a blast of noise or a squeal is produced, the tube in question should be replaced.

In general, however, the most satisfactory method of determining whether some of the tube elements are shorted, and whether the tube's emission or transconductance characteristics are normal for its type, is to use a well designed tube tester. However, it should be noted that the tube tester cannot always be looked upon as a final authority for determining whether or not a particular tube will operate satisfactorily in a given receiver. This is due to the fact that this tube might be operating in the receiver on a portion of its characteristic curve which is not covered in the tube tester, or it might be operating in the set with voltages much higher or lower than those used in the tube tester. All deviations from normal readings should make a tube liable to suspicion. An excessively high reading may indicate a defective tube as readily as one that is too low.

The check for filament continuity and for shorted tube elements is generally performed as the first part of the testing procedure. If the filament is found to be open, it is useless to attempt further testing of that tube. If shorted elements are discovered, it is not advisable to test further, as the shorted elements may blow fuses or damage instruments in later tests. Filament continuity and shorted elements are usually indicated by the lighting of a small neon or pilot lamp on the instrument panel.

If the tube passes the short and filament continuity test, it is next tested for merit or quality. The greatest difference between various types of tube testers is in the selection of a suitable characteristic for the quality test. Testers are divided on this basis into two great classes, the emission type and the transconductance type.

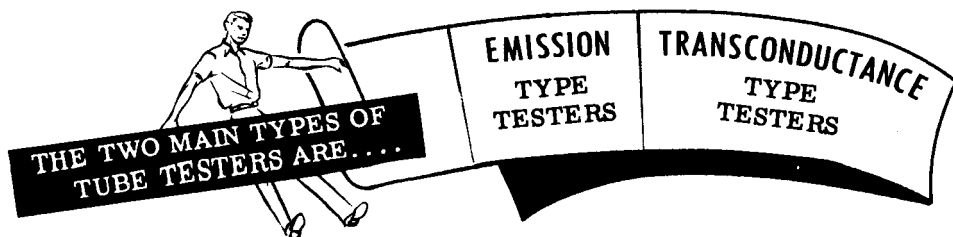

Vacuum Tube Testing (continued)

The emission-type tester determines the merit of the tube by measuring the amount of cathode current flowing when the filament is operated at its rated voltage and a positive voltage is applied to the plate. Since it is desired to measure only cathode emission in this test, the control grid, screen grid and suppressor grid are connected to the plate. Therefore, all tubes, whether they are diodes, triodes, tetrodes or pentodes, are tested as diodes. It is the simplest and cheapest method of testing the quality of a tube, but it is also the least satisfactory method.

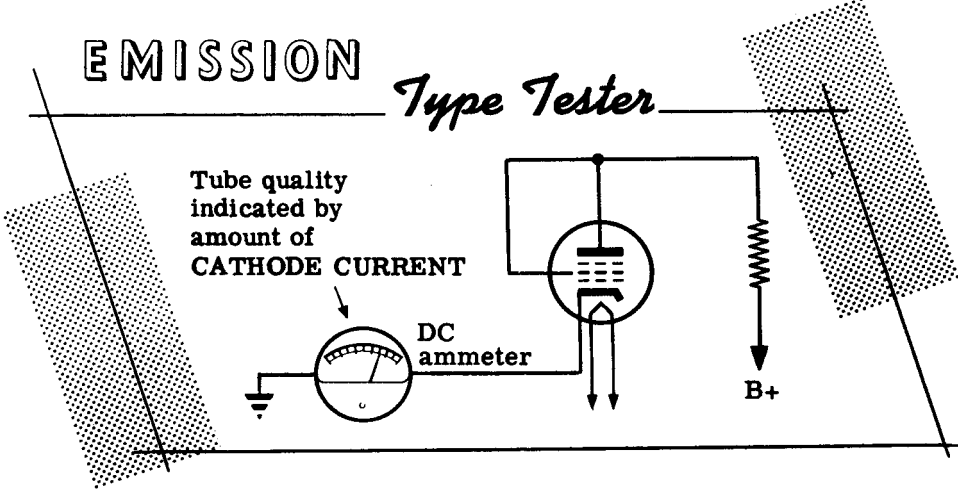

The mutual conductance or transconductance type of tester simulates the normal operation of the tube by applying a known signal to the grid and measuring the strength of the amplified signal in the plate circuit by means of an output meter. Since this procedure is performed under conditions which resemble the actual operating conditions of the tube in a receiver, the results obtained by using a transconductance-type tester give a better indication of a tube's serviceability than the results obtained from an emission-type tester.

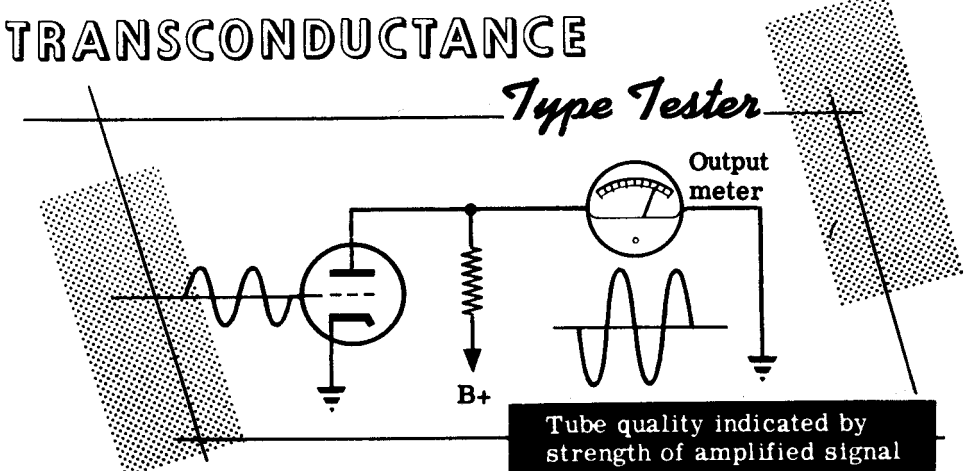

# RECEIVERS

## Review of Receivers

**ANTENNA FUNCTION**—The purpose of a receiving antenna is to pick up electromagnetic waves radiated by transmitting antennas. These waves, in cutting the antenna, induce voltages in it, causing a current to flow. The current flows into the input of the receiver, where it generates a signal which is amplified by the receiver circuits.

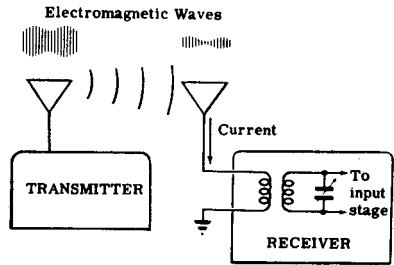

## DIRECTIONAL CHARACTERISTICS

The position of a receiving antenna, relative to the transmitting antenna, will determine the strength of signal that it picks up. If a loop receiving antenna is broadside to a loop transmitting antenna, the signal picked up will be of maximum amplitude. If the loop is turned so that its edge faces the broad side of the transmitting antenna, a very weak signal will be picked up. Therefore, the antenna is said to have directional characteristics.

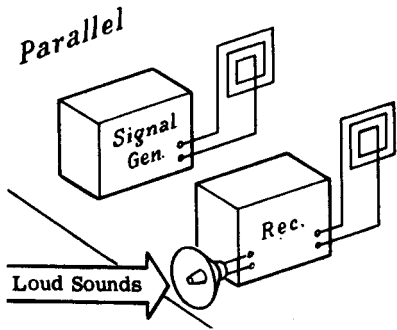

**RF AMPLIFIER STAGE**—An RF amplifier stage in a receiver improves the sensitivity and selectivity of the receiver. The added sensitivity is due to the amplification of the desired signal, and the added selectivity results from the use of tuned circuits which discriminate between the desired and undesired signals.

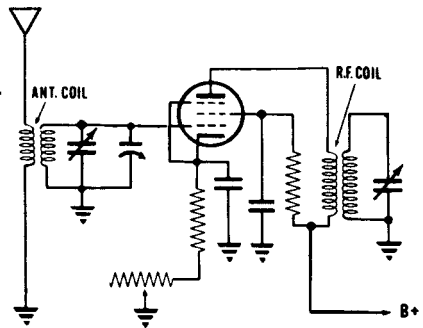

**AUDIO AMPLIFIER STAGE**—An audio amplifier stage in a receiver amplifies the detected audio signal. Audio stages, which precede the last stage, are voltage amplifiers whose sole function is to increase the amplitude of the audio to the level where it is large enough to drive the last stage. The last stage, called the "power stage," supplies the large current variations necessary to drive the speaker.

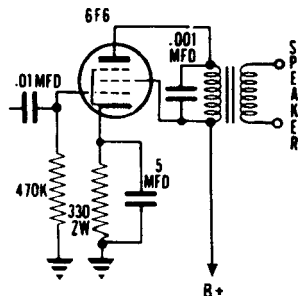

# RECEIVERS

## Review of Receivers (continued)

**DETECTORS**—The function of a detector in a receiver is to remove the audio component from a modulated RF signal so that it can be amplified by AF stages. A simple detector consists of a tuned circuit, a rectifier, and a filter. Such a detector is called a "diode detector."

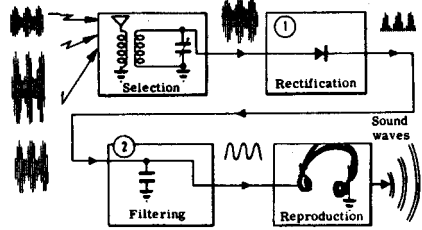

**GRID-LEAK DETECTOR**—This type is basically a diode detector with amplification added. The grid and cathode form the diode detector with the grid acting as the plate. The rectified signal, developed across the grid-leak resistor, is amplified in the plate circuit. This detector is more sensitive than the diode type.

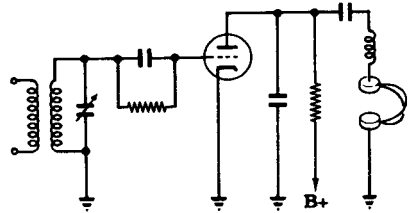

**REGENERATIVE DETECTOR**—This modified grid-leak type is still more sensitive. A feedback loop in the plate is coupled to the grid coil to provide regeneration, thus effectively increasing the gain of the stage.

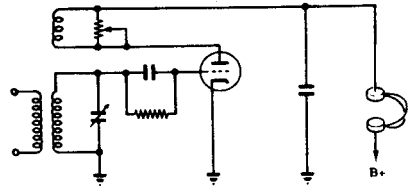

**PLATE DETECTOR**—This detector employs a triode or pentode, biased near cut-off. Rectification takes place in the plate circuit since the negative half of the modulated RF grid signal drives the tube into cut-off.

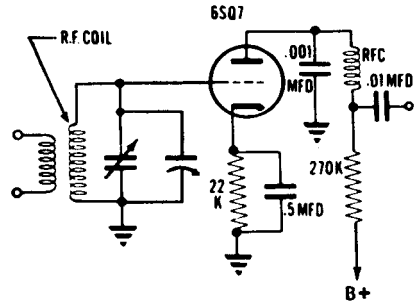

**TRF RECEIVER**—This receiver employs RF amplifiers, a detector and AF amplifiers. The tuned circuits are ganged-capacitor tuned. A shortcoming of the TRF is that since the tuned circuits are not fixed-tuned, constant sensitivity and selectivity cannot be realized over a tunable band.



**TRF RECEIVER**  
All tank circuits gang tuned

Review (continued)

**SUPERHETERODYNE RECEIVER—**

The aforementioned disadvantage of the TRF is overcome in the superhet receiver, in which all desired RF signals are converted to the same fixed lower signal (called the "intermediate frequency") where the signal is amplified by fixed tuned circuits before it is detected. To accomplish this, the superhet incorporates a mixer, local oscillator and IF amplifier in addition to the usual TRF stages.

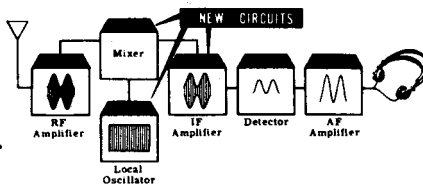

**OBTAINING THE IF SIGNAL—**The fixed IF signal is gotten by beating the incoming signal with the signal from a local oscillator which is always a fixed amount away from the incoming signal. This is accomplished by gang tuning the oscillator and the RF amplifier so that the difference between the RF tank resonant frequency and the oscillator tank resonant frequency is constant for all settings of the tuning dial. The oscillator tank resonant frequency is said "to track" the RF tank resonant frequency.

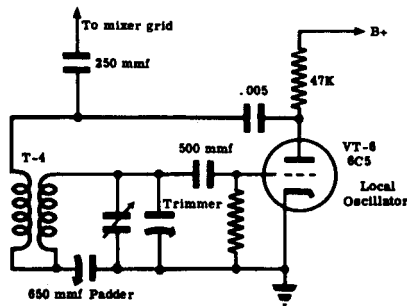

**AUTOMATIC VOLUME CONTROL—**The superhet receiver incorporates an AVC circuit whose function is to equalize the receiver output for both strong and weak incoming signals. It does this using a filter circuit which charges up to the DC level of the rectified RF wave. This DC voltage (negative with respect to ground) is then applied as bias to the grids of the IF, mixer and RF stages, all of which employ variable-mu tubes. In this way the bias voltage, and therefore the gain, of the stage is directly related to the intensity of the received signal.

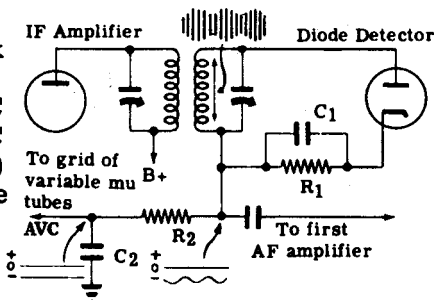

**ALIGNING—**When aligning a superhet the IF stages are adjusted first. Then the trimmers of the RF tuned circuits and local oscillator are adjusted at the high end of the band. The adjustment of the low frequency end of the band is made with the padder capacitor.

**STEPS IN ALIGNING**

- ① IF trimmers.
- ② RF tuned circuit trimmers and local oscillator trimmer at high end.
- ③ Local oscillator trimmer at low end.
  - a. Rocking in.

# CONCLUSION TO BASIC ELECTRONICS

## What You Have Learned

You have just completed the course in Basic Electronics. Looking back on the weeks you have spent studying these materials, what should you be able to do with the information you have now? If you can recognize the three basic electronic circuits—the rectifier, amplifier and oscillator—in a schematic diagram, if you understand how each component functions within these circuits, and what part the entire circuit plays in a piece of equipment, then you "know your stuff".

## THESE ARE BASIC TO ALL ELECTRONIC EQUIPMENT

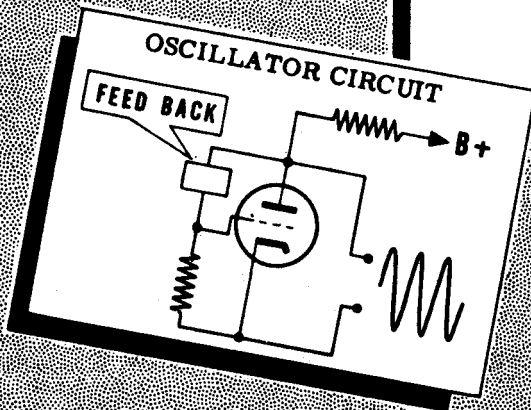
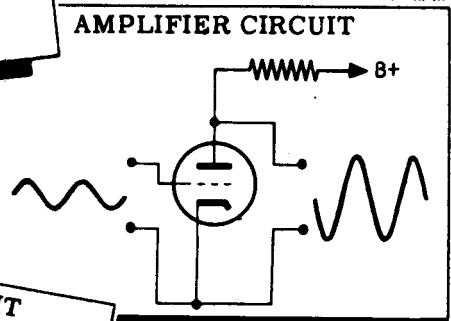
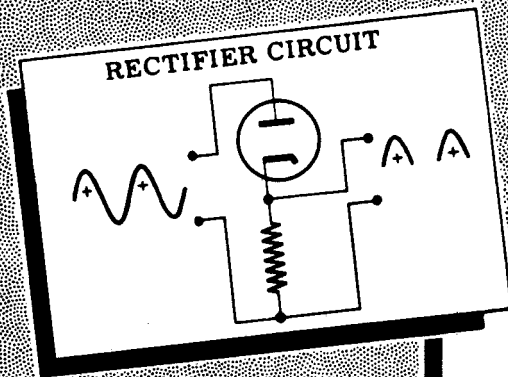

# INDEX TO VOL. 5

(Note: A cumulative index covering all five volumes in this series will be found immediately following this index to Volume 5.)

- AF amplifier, tone control circuits, 5-34
  - volume control, 5-35
- AF amplifier circuits, analysis of, 5-36
- AF and RF amplifiers, comparison of, 5-37
- Alignment, what it is, 5-80
- Alignment procedure, 5-81
- Antennas, directivity as a consideration in
  - selecting and installing, 5-22
  - frequency response as a consideration in selecting and installing, 5-22
  - noise as a consideration in selecting and installing, 5-19, 5-20
  - receiver, 5-16 to 5-23
  - receiver, function of, 5-16
  - receiver, types of, 5-17, 5-18
  - signal losses as a consideration in selecting and installing, 5-21
- Audio, first stage, analysis of, 5-79
- Audio amplifiers, how they work in the superheterodyne receiver, 5-72
- Audio power amplifiers, what they do, 5-33
  
- Band switching, in TRF receivers, 5-28
  
- Capacitors, ganged, 5-29
  - trimmer, 5-30
- Coils, 5-30
- Communication, history of, 5-1 to 5-4
  - modern wireless, 5-5
- Crystal receivers, 5-11
  
- Demonstration, Aligning the IF Section, 5-84
  - Aligning the Mixer and Oscillator, 5-85, 5-86
- Detector, analysis of the plate detector circuit, 5-56
  - analysis of regenerative type circuit, 5-52
  - characteristics of the crystal type, 5-41
  - crystal type, 5-39
  - diode type, 5-42
  - grid-leak type, 5-43, 5-44
  - how the crystal type works, 5-40
  - how the plate type works, 5-54, 5-55
  - how the regenerative type works, 5-46 to 5-48
  - how they work in the superheterodyne receiver, 5-71
  - oscillating, 5-51
  - regenerative, 5-45
  - regenerative type as CW receiver, 5-49, 5-50
  - what they do, 5-38
- Detector stage, diode type, analysis of, 5-79
  
- Fidelity, in the receiver, 5-10
  
- IF amplifier, how it works in the superheterodyne receiver, 5-70
- IF stage, analysis of, 5-78
  
- Mixer stage, analysis of, 5-78
  - how it works in the superheterodyne receiver, 5-66 to 5-69
  
- Oscillators, beat frequency,
  - how they work, 5-75
  - local, in superheterodyne receivers, 5-63 to 5-65
  - local stage, analysis of, 5-77
  
- Receivers, introduction to, 5-1 to 5-15
  - recently developed uses of, 5-14, 5-15
  - the jobs they perform, 5-6, 5-7
- Review, Receivers, 5-97 to 5-99
  - Receiver Antennas, 5-23

## INDEX TO VOL. 5

- The Superheterodyne Receiver, 5-87, 5-88**
- TRF Receivers — Regenerative Detector, 5-53**
- RF amplifier, analysis of, 5-32**
- RF amplifier stage, in superheterodyne receivers, 5-61, 5-62**
  - in TRF receivers, 5-25**
- RF and AF amplifiers, comparison of, 5-37**
- RF transformers, 5-26, 5-27**
- Selectivity, in the receiver, 5-9**
- Sensitivity, in the receiver, 5-8**
- Sensitivity measurements, importance of, 5-83**
  - what they are, 5-82**
- Superheterodyne receivers, 5-13, 5-57 to 5-96**
  - at high frequencies, 5-58**
  - complete schematic of, 5-76**
  - how they work, 5-59**
  - introduction to, 5-57**
  - selectivity of, 5-60**
  - troubleshooting, 5-89 to 5-96**
- TRF receivers, 5-12, 5-24 to 5-56**
  - audio amplifier stage, 5-33 to 5-37**
  - plate detector, 5-54 to 5-56**
  - regenerative detector, 5-38 to 5-53**
  - RF amplifier stage, 5-24 to 5-32**
- Troubleshooting, by signal injection, 5-90, 5-92**
  - by signal tracing, 5-90, 5-91**
  - superheterodyne circuits, 5-93, 5-94**
- Troubleshooting method, review of, 5-89**
- Vacuum tube testing, 5-95, 5-96**
- Volume control automatic, how it works in the superheterodyne receiver, 5-72 to 5-74**
  - grid bias manual type, 5-31**



# CUMULATIVE INDEX

(Note: The first number in each entry identifies the volume in which the information is to be found; the second number identifies the page.)

- AC-DC half-wave rectifier, in power supplies, 1-94, 1-95
- AF amplifier, tone control circuits, 5-34
  - volume control, 5-35
- AF amplifier circuit, analysis of, 5-36
- AF and RF amplifiers, comparison of, 5-37
- Alignment, what it is, 5-80
- Alignment procedure, 5-81
- Amplification examples of, 2-1 to 2-3
- Amplifiers, 2-1 to 2-10
  - amplification in, 3-15
  - characteristics of audio power type, 2-71 to 2-73
  - characteristics of transformer-coupled type, 2-69, 2-70
  - characteristics of the two-stage type, 2-60, 2-61
  - classes of, 2-30, 2-31
  - diagram of push-pull type, 2-84
  - how the push-pull type works, 2-78 to 2-80
  - how they work, 2-17 to 2-19
  - push-pull type, 2-78 to 2-86
  - review of classes of operation, 4-8
  - single-stage, 2-55 to 2-57
  - transformer coupled, 2-67 to 2-70
  - triode type, 2-24 to 2-41
  - two-stage RC coupled type, 2-58 to 2-66
  - typical stage, 2-55
- Amplitude modulation, 4-85 to 4-99
  - percentage modulation, 4-97, 4-98
  - time base modulation pattern, 4-92
  - trapezoid figure, 4-93 to 4-96
  - what it is, 4-85
- Antennas, 4-63 to 4-79
  - basic, 4-66
  - directivity as a consideration in selecting and installing, 5-22
  - fading, 4-73
  - frequency response as a consideration in selecting and installing, 5-22
  - ground wave, 4-72
  - how they work, 4-64, 4-65
  - impedance, 4-68
  - noise as a consideration in selecting and installing, 5-19, 5-20
  - purpose of, 4-63
  - radiation pattern, 4-70
  - radiation resistance, 4-67
  - receiver, 5-16 to 5-23
  - receiver, function of, 5-16
  - receiver, types of, 5-17, 5-18
  - signal losses as a consideration in selecting and installing, 5-21
  - sky wave, 4-72
  - space wave, 4-73
  - tuning, 4-69
  - wave propagation, 4-71
- Armstrong oscillators, 3-55 to 3-61
  - advantages of grid leak bias in, 3-60
  - advantages of push-pull type, 2-85
  - frequency instability in, 3-61
  - grid leak bias in, 3-56
    - how oscillations are maintained in, 3-57, 3-58
- Audio, first stage, analysis of, 5-79
- Audio amplifiers, how they work in the superheterodyne receiver, 5-72
- Audio power amplifiers, what they do, 5-33
- Band pass, 3-37
- Band switching, in TRF receivers, 5-28
- Beam power tube, 2-50, 2-51
  - construction of a typical tube, 2-51
- Bias, B+ power supply, 2-34
  - battery, 2-32
  - cathode, 2-35
  - grid voltage, 2-24 to 2-26
  - power supply, 2-33
- Bridge rectifier circuits, 1-49, 1-50
- Capacitors, ganged, 5-29
  - how they are connected to the RF amplifier tube, 3-30
  - trimmer, 5-30
  - tuning, 3-25
- Cathode bypass capacitor, 2-38 to 2-40
- Cathode resistor, 2-36, 2-37
- Class C amplifiers, 4-8 to 4-15
  - combination bias, 4-14
  - fixed bias, 4-11
  - self-bias, 4-12, 4-13
  - tuned, 4-9, 4-10
- Coils, 5-30
  - how they are connected to the RF amplifier tube, 3-30
  - tuning, 3-26
- Colpitts oscillators, 3-64
- Communication, history of, 5-1 to 5-4
  - modern wireless, 5-5
- Compensating networks, high-frequency compensation, 3-5
  - low-frequency compensation, 3-6
- Coupling, amplifier stages, 5-59
  - transformer, 2-67, 2-68
- Coupling circuits, 4-40
  - tuned, 4-41
- Crystals, as resonators, 3-69
- Crystal oscillators, 3-68 to 3-73
  - analysis of, 3-72
  - introduction to, 3-68
  - tuning in, 3-71
- Crystal oscillator circuits, 3-70
- Crystal receivers, 5-11
- Current flow, in full-wave rectifier circuits, 1-48
  - in half-wave rectifier circuits, 1-43
- CW transmission, 4-80 to 4-84
  - advantage of, 4-80
  - blocked-grid keying, 4-83
  - cathode keying, 4-81, 4-82
  - keyer tube circuits, 4-84
- Decoupling filters, 2-56, 2-57
- Degeneration, 3-7 to 3-9
- Demonstration, Aligning the IF Section, 5-84

# CUMULATIVE INDEX

- Aligning the Mixer and Oscillator, 5-85, 5-86
- Current Distribution Along an Antenna, 4-75
- Radiation Pattern of an Antenna, 4-76 to 4-78
- Transmission Lines, 4-57 to 4-61
- Detectors, analysis of the plate detector circuit, 5-56
  - analysis of the regenerative type circuit, 5-52
  - characteristics of the crystal type, 5-41
  - crystal type, 5-39
  - diode type, 5-42
  - grid-leak type, 5-43, 5-44
  - how the crystal type works, 5-40
  - how the plate type works, 5-54, 5-55
  - how the regenerative type works, 5-46 to 5-48
  - how they work in the superheterodyne receiver, 5-71
  - oscillating, 5-51
  - regenerative, 5-45
  - regenerative type as CW receiver, 5-49, 5-50
  - what they do, 5-38
- Detector stage, diode type, analysis of, 5-79
- Diodes, characteristics of, 1-109 to 1-112
  - current flow in, 1-28, 1-29
  - gas-filled, 1-35
  - how current is controlled in, 1-112
  - how they work, 1-25
  - in transformer type circuits, 1-40, 1-41
  - vacuum-filled in power supplies, 1-36
- Dynamotors, 1-104
- Earphones, 2-93
- Electron-coupled oscillators, 3-74 to 3-77
  - analysis of, 3-77
  - introduction to, 3-74
- Electron-coupled oscillator circuits, 3-75, 3-76
- Electronics, meaning of, 1-1
- Electronic equipment, 1-2
  - parts used in, 1-3
- Fidelity, in the receiver, 5-10
- Filters, improving operation of, 1-64, 1-65
  - power supplies, 1-12
- Filter capacitors (condensers), 1-60 to 1-63
  - electrolytic, 1-61 to 1-63
  - electrolytic dry, 1-63
  - electrolytic wet, 1-62
  - paper, construction of, 1-60
  - paper, high-voltage, 1-60
- Filter chokes, 1-69
- Filter circuits, 1-52 to 1-80
  - capacitors in, 1-57 to 1-59
  - capacitor input, filter circuit, single-section, 1-70, 1-72
  - choke input, filter circuit, single-section, 1-70, 1-71
  - in power supplies, 1-53
  - parallel resonant, 1-73
  - RC, faults of, 1-66, 1-67
  - series-resonant, 1-73
  - two-section, 1-73
  - using choke instead of resistor, 1-68
- Frequency, 4-43
- Frequency doubling, 4-36
- Frequency measurement, using standing waves, 4-53
- Frequency multiplication, purpose of, 4-34
- Frequency multipliers, 4-34 to 4-38
  - final power amplifier, 4-35
  - tuning indications, 4-38
- Frequency response, 2-62 to 2-64
  - curve, 2-65
  - improving, 3-7 to 3-9
- Frequency spectrum, 4-74
- Frequency tripling, 4-37
- Gain, increase of, 2-58
- Hartley oscillators, 3-62, 3-63
  - how oscillations are maintained, 3-63
- High frequency oscillators, 3-82
  - tuned lines in, 3-83
- IF amplifier, how it works in the superheterodyne receiver, 5-70
- IF stage, analysis of, 5-78
- Impedance matching, 2-76, 2-77
- Input filter capacitor, 1-74
- Inverters, 1-105
- Klystron tubes, 3-85
- LC circuits, parallel, 3-21, 3-22
  - series, 3-20
- Loudspeakers, dynamic type, 2-94
- Microphones, 2-88 to 2-92
  - carbon, 2-89
  - characteristics of, 2-88
  - crystal, 2-90
  - dynamic type, 2-91
  - ribbon or velocity type, 2-92
- Mixer stage, analysis of, 5-78
  - how it works in the superheterodyne receiver, 5-66 to 5-69
- Modulation, grid, 4-90
  - how it is accomplished, 4-87
  - other methods of, 4-91
  - plate, 4-89
- Modulators, 4-88
- Motor generators, 1-104
- Oscillations, frequency of, 3-59
  - what they are, 3-45 to 3-47
- Oscillators, 3-41 to 3-89
  - beat frequency, how they work, 5-75
  - different grounding points in, 3-80
  - electronic, 3-48 to 3-52
  - feedback circuits in, 3-53
  - frequency stability of, 3-54
  - introduction to, 3-43 to 3-54
  - local, in superheterodyne receivers, 5-63 to 5-65
  - local stage, analysis of, 5-77
  - other circuits, 3-81

# CUMULATIVE INDEX

- RF ground potential, 3-79
- series feed, 3-78
- shunt feed, 3-78
- what they do, 3-44
- why they are studied, 3-43
- Output transformers, 2-74 to 2-77**
  - job of, 2-74, 2-75
- Pentodes, 2-47 to 2-49, 2-52, 2-53**
  - construction of a typical tube, 2-49
  - how they work, 2-48
  - remote cut-off, 3-32, 3-33
  - summary of operation of, 2-52, 2-53
  - why they are used in RF amplifiers, 3-28, 3-29
- Phase inverters, 2-81 to 2-83**
  - another type of, 2-83
  - how they work, 2-82
- Power line filter capacitor circuits, 1-43**
- Power supplies, circuits in, 1-52**
  - dry metal rectifier, 1-97
  - for DC voltage sources, 1-99
  - general types, 1-93
  - importance of, 1-7
  - need for other types, 1-92
  - transformer type, 1-39
  - transformerless, 1-94 to 1-98
  - transformerless and chokeless, 1-98
  - voltage doubler, 1-96
  - what they do, 1-8
  - why there are different types, 1-14 to 1-16
- Receivers, introduction to, 5-1 to 5-15**
  - recently developed uses of, 5-14, 5-15
  - the jobs they perform, 5-6, 5-7
- Rectifiers, changing AC to DC in half-wave**
  - dry metal type, 1-17
  - copper oxide, 1-18
  - circuits in dry metal half-wave type, 1-21
  - description of half-wave dry metal type, 1-18 to 1-20
  - dry metal half-wave, 1-17 to 1-22
  - full-wave, 1-45 to 1-51
  - full-wave, how they work, 1-46
  - gas-filled diodes, 1-35 to 1-37
  - parallel connection of elements in dry metal type, 1-19
  - power supplies, 1-10, 1-11
  - selenium, 1-18, 1-20
  - series stacking of elements in dry metal type, 1-19
  - transformer type, half-wave, 1-39 to 1-44
  - vacuum tubes, 1-23
  - vacuum tube half-wave type, 1-23 to 1-38
- Rectifier circuits, half-wave vacuum tube, 1-33**
- Rectifier output, AC and DC components in, 1-55, 1-56**
  - characteristics of, 1-54
  - filtering half- and full-wave, 1-74
- Rectifier tubes, 1-30, 1-31**
  - cathode type, 1-31
  - diodes, 1-30, 1-31
  - directly heated, 1-32
  - full-wave, 1-47
  - indirectly heated, 1-32
  - plates connected together, 1-32
  - plates connected separately, 1-32
- Resistors, bleeder, 1-75 to 1-77**
- Resonators, cavity type at ultra-high frequencies, 3-84**
- Resonant circuits, how stations are selected, 3-23**
- Review, A Single-Stage RF Amplifier, 3-34**
  - A Three-Stage Transmitter, 4-33
  - Amplitude Modulation, 4-99
  - Antennas, 4-79
  - Audio Amplifiers, 2-96 to 2-98
  - Class C Amplifiers, 4-15
  - Diode Characteristics, 1-111
  - Filter Circuits, 1-78 to 1-80
  - Full-Wave Rectifier Circuit, 1-51
  - Half-Wave Rectifiers — Dry Metal Type, 1-22
  - Half-Wave Rectifiers — Transformer Type, 1-44
  - Half-Wave Rectifiers — Vacuum Tube Type, 1-38
  - Microphones, Earphones and Loudspeakers, 2-95
  - Miscellaneous Oscillators, 3-86, 3-87
  - Oscillators, 3-88, 3-89
  - Other Types of Power Supply Circuits, 1-106 to 1-108
  - Power Supplies, 1-113 to 1-115
  - Receivers, 5-97 to 5-99
  - Receiver Antennas, 5-23
  - The Armstrong and Hartley Oscillators, 3-65
  - The Push-Pull Amplifier, 2-86
  - The Superheterodyne Receiver, 5-87, 5-88
  - The Tetrode and the Pentode, 2-54
  - The Triode, 2-23
  - The Triode Amplifier, 2-41
  - The Tuned-Plate Tuned-Grid and Crystal Oscillators, 3-73
  - The Two-Stage RC Coupled Amplifier, 2-66
  - The Two-Stage RF Amplifier, 3-39
  - Transmission Lines, 4-62
  - Transmitters, 4-100 to 4-102
  - TRF Receivers — Regenerative Detector, 5-53
  - Tuned Circuits, 3-27
  - Video Amplifiers, 3-10, 3-11
  - Voltage Regulator Circuits, 1-91
- RF amplifiers, 3-13 to 3-39**
  - analysis of, 5-32
  - introduction to, 3-15 to 3-18
  - two-stage, 3-35 to 3-39
  - single-stage, 3-28 to 3-34
  - what they do, 3-16, 3-17
- RF amplifier circuit, development of, 3-31**
- RF amplifier stage, in superheterodyne receivers, 5-61, 5-62**
  - in TRF receivers, 5-25
- RF and AF amplifiers, comparison of, 5-37**
- RF stages, how they are coupled, 3-38**
  - why more than one is used, 3-35, 3-36
- RF transformers, in TRF receivers, 5-26, 5-27**

# CUMULATIVE INDEX

- Rotary converters, 1-105
- Selectivity, 3-37
  - and "Q", 3-24
  - in the receiver, 5-9
- Sensitivity, in the receiver, 5-8
- Sensitivity measurements, importance of, 5-83
  - what they are, 5-82
- Sidebands, 4-86
- Sound, principles of, 2-87
- Square waves, distortion of, 3-3, 3-4
- Superheterodyne receivers, 5-13, 5-57 to 5-96
  - at high frequencies, 5-58
  - complete schematic of, 5-76
  - how they work, 5-59
  - introduction to, 5-57
  - selectivity of, 5-60
  - troubleshooting, 5-89 to 5-96
- Tetrodes, 2-42 to 2-46
  - eliminating effects of secondary emission, 2-47
  - normal operation of, 2-46
  - screen grid, 2-43
  - secondary emission, 2-44
  - static characteristics of, 2-45
  - why they were developed, 2-42
- Three-stage transmitters, 4-16 to 4-33
  - complete diagram of, 4-21
  - intermediate power amplifier, 4-18
  - neutralization, 4-27 to 4-29
  - neutralizing procedures, 4-30, 4-31
  - oscillators, 4-17
  - parasitic oscillations, 4-32
  - power amplifier, 4-19
  - purpose of tuning, 4-22
  - three basic circuits, 4-16
  - transmitting tube filament circuit, 4-20
  - tuning methods, 4-23 to 4-26
- Transformers, power supplies, 1-9
- Transformer type circuit, diagram of, 1-42
  - operation of, 1-43
- Transmission, AM, 4-6
  - FM, 4-6
  - keyed, 4-5
  - voice, 4-6
- Transmission lines, 4-39 to 4-62
  - characteristic impedance of, 4-45
  - equivalent circuit of, 4-44
  - input impedance of a line, 4-50
  - input impedance of an open-circuited line, 4-52
  - input impedance of a short-circuited line, 4-51
  - line termination in characteristic impedance, 4-46
  - nonresonant and resonant lines, 4-47
  - open and shorted, 4-49
  - standing waves on rope, 4-48
  - transferring electrical energy, 4-42
  - types of, 4-56
- Transmission line principles, 4-54, 4-55
- Transmitters, a simple type, 4-2 to 4-4
  - overall, 4-39
  - what they are, 4-1 to 4-7
- TRF receivers, 5-12, 5-24 to 5-56
  - audio amplifier stage, 5-33 to 5-37
  - plate detector, 5-54 to 5-56
  - regenerative detector, 5-38 to 5-53
  - RF amplifier stage, 5-24 to 5-32
- Triodes, 2-11 to 2-23
  - control grid in, 2-14, 2-15
  - construction of typical tube, 2-12
  - how they work, 2-13
  - similarity to the diode, 2-16
- Triode amplifiers, why proper bias is necessary, 2-27 to 2-29
- Triode tube characteristics, amplification factor, 2-20
  - plate resistance, 2-21
  - transconductance, 2-22
- Troubleshooting, by signal injection, 5-90, 5-92
  - by signal tracing, 5-90, 5-91
  - superheterodyne circuits, 5-93, 5-94
- Troubleshooting method, review of, 5-89
- Tuned circuits, what they are, 3-19
- Tuned-plate tuned-grid oscillators, 3-66, 3-67
  - feedback in, 3-67
  - introduction to, 3-66
- Vacuum tubes, amplification, 2-11
  - circuit wiring, 1-34
  - discovery of diode, 1-24
  - electron emission, 1-26, 1-27
  - factors common to all, 1-110
  - how they were developed, 2-8, 2-9
  - jobs of, 1-109
  - methods of representation in diagrams, 1-34
  - sockets, 1-31
  - types of, 2-6, 2-7
  - what they can do, 2-4, 2-5
- Vacuum tube testing, 5-95, 5-96
- Vibrators, 1-100 to 1-103
  - synchronous, 1-103
- Video amplifiers, 3-1 to 3-11
  - introduction to, 3-1, 3-2
- Voltage regulators, 1-81, 1-82
- Voltage regulation, when load current varies, 1-87, 1-88
  - when power supply voltage varies, 1-89, 1-90
- Voltage regulators, power supply, 1-13
- Voltage regulator circuits, 1-81 to 1-91
- Voltage regulator tube, 1-83, 1-84
- Voltage regulator tube circuit, 1-85, 1-86
- Volume control, automatic, how it works in the superheterodyne receiver, 5-72 to 5-74
  - grid bias manual type, 5-31
- Wavelength, 4-43

## HOW THIS OUTSTANDING COURSE WAS DEVELOPED:

In the Spring of 1951, the Chief of Naval Personnel, seeking a streamlined, more efficient method of presenting Basic Electricity and Basic Electronics to the thousands of students in Navy speciality schools, called on the graphiological engineering firm of Van Valkenburgh, Nooger & Neville, Inc., to prepare such a course. This organization, specialists in the production of complete "packaged training programs," had broad experience serving industrial organizations requiring mass-training techniques.

These were the aims of the proposed project, which came to be known as the Common-Core program: to make Basic Electricity and Basic Electronics completely understandable to every Navy student, regardless of previous education; to enable the Navy to turn out trained technicians at a faster rate (cutting the *cost* of training as well as the time required) without sacrificing subject matter.

The firm met with electronics experts, educators, officers-in-charge of various Navy schools and, with the Chief of Naval Personnel, created a dynamic new training course . . . completely up-to-date . . . with heavy emphasis on the visual approach.

First established in selected Navy schools in April, 1953, the training course comprising Basic Electricity and Basic Electronics was such a tremendous success that it is now the *backbone* of the Navy's *current* electricity and electronics training program!\*

The course presents one fundamental topic at a time, taken up in the order of need, rendered absolutely understandable, and hammered home by the use of clear, cartoon-type illustrations. These illustrations are the most effective ever presented. *Every page has at least one such illustration—every page covers one complete idea!* An imaginary instructor stands figuratively at the reader's elbow, doing demonstrations that make it easier to understand each subject presented in the course.

Now, for the first time, Basic Electricity and Basic Electronics have been released by the Navy for civilian use. While the course was *originally* designed for the Navy, the concepts are so broad, the presentation so clear—*without* reference to specific Navy equipment—that it is ideal for use by schools, industrial training programs, or home study. *There is no finer training material!*

"Basic Electronics" consists of *five* volumes, as follows: *Vol. 1—Introduction to Electronics, Diode Vacuum Tubes, Dry Metal Rectifiers, What a Power Supply Is, Filters, Voltage Regulators. Vol. 2—Introduction to Amplifiers, The Triode Tube, Tetrodes & Pentodes, Audio Voltage & Power Amplifiers. Vol. 3—Video Amplifiers, RF Amplifiers, Oscillators. Vol. 4—Transmitters, Transmission Lines & Antennas, CW Transmission & Amplitude Modulation. Vol. 5—Receiver Antennas, Detectors & Mixers, TRF Receivers, Superheterodyne Receivers.*

\*"Basic Electricity," the first portion of this course, is available as a separate series of volumes.

**JOHN F. RIDER PUBLISHER, INC., 116 WEST 14th ST., N. Y. 11, N. Y.**